



SiUS04-924

Service Manual

Inverter Pair Wall Mounted Type H-Series



- [Applied Models]
- Inverter Pair : Heat Pump

Inverter Pair H-Series

●Heat Pump

Indoor Units

FTXS30HVJU

FTXS36HVJU

Outdoor Units

RXS30HVJU

RXS36HVJU

Inverter Pair

H-Series

Part 1

List of Functions	1
1. List of Functions	2

Part 2

Specifications	3
1. Specifications	4

Part 3

Printed Circuit Board

Connector Wiring Diagram	6
1. Printed Circuit Board Connector Wiring Diagram.....	7
1.1 Indoor Unit.....	7
1.2 Outdoor Unit.....	9

Part 4

Function and Control	11
1. Main Functions	12
1.1 Frequency Principle.....	12
1.2 Airflow Direction Control.....	14
1.3 Fan Speed Control for Indoor Units.....	15
1.4 Program Dry Function	16
1.5 Automatic Operation.....	17
1.6 Thermostat Control.....	18
1.7 NIGHT SET Mode	19
1.8 ECONO Mode	20
1.9 INTELLIGENT EYE	21
1.10 Inverter POWERFUL Operation	23
1.11 Other Functions.....	24
2. Function of Thermistor	26
3. Control Specification	27
3.1 Mode Hierarchy	27
3.2 Frequency Control.....	28
3.3 Controls at Mode Changing / Start-up.....	30
3.4 Discharge PipeTemperature Control.....	32
3.5 Input Current Control.....	33
3.6 Freeze-up Protection Control	34
3.7 Heating Peak-Cut Control	34
3.8 Fan Control.....	35
3.9 Liquid Compression Protection Function 2.....	35
3.10 Defrost Control	35
3.11 Electronic Expansion Valve Control	37
3.12 Malfunctions	40
3.13 Forced Operation Mode	41
3.14 Additional Functions	41
3.15 Facility Setting Switch (cooling at low outdoor temperature).....	42

Part 5

Operation Manual	44
1. System Configuration.....	45
2. Instruction.....	46
2.1 Remote Controller	46
2.2 AUTO · DRY · COOL · HEAT · FAN Operation	48
2.3 Adjusting the Airflow Direction.....	50
2.4 COMFORT AIRFLOW Operation	52
2.5 INTELLIGENT EYE Operation	53
2.6 POWERFUL Operation	55
2.7 OUTDOOR UNIT QUIET Operation.....	56
2.8 ECONO Operation	57
2.9 TIMER Operation	58

2.10 WEEKLY TIMER Operation	60
-----------------------------------	----

Part 6

Service Diagnosis.....	66
1. Caution for Diagnosis.....	67
2. Problem Symptoms and Measures	68
3. Service Check Function	69
4. Troubleshooting	72
4.1 Error Codes and Description	72
4.2 Indoor Unit PCB Abnormality	73
4.3 Freeze-up Protection Control or High Pressure Control.....	74
4.4 Fan Motor (DC Motor) or Related Abnormality.....	76
4.5 Thermistor or Related Abnormality (Indoor Unit).....	78
4.6 Signal Transmission Error (between Indoor and Outdoor Unit)	79
4.7 Unspecified Voltage (between Indoor and Outdoor Units)	80
4.8 Outdoor Unit PCB Abnormality.....	81
4.9 OL Activation (Compressor Overload)	82
4.10 Compressor Lock	83
4.11 DC Fan Lock	84
4.12 Input Overcurrent Detection	85
4.13 Four-Way Valve Abnormality.....	86
4.14 Discharge Pipe Temperature Control.....	88
4.15 High Pressure Control in Cooling	89
4.16 Compressor System Sensor Abnormality	90
4.17 Position Sensor Abnormality	91
4.18 CT or Related Abnormality	93
4.19 Thermistor or Related Abnormality (Outdoor Unit).....	95
4.20 Electrical Box Temperature Rise.....	97
4.21 Radiation Fin Temperature Rise	98
4.22 Output Overcurrent Detection	100
4.23 Insufficient Gas.....	102
4.24 Low-voltage Detection or Over-voltage Detection.....	104
4.25 Signal Transmission Error on Outdoor Unit PCB	105
5. Check	106
5.1 How to Check.....	106

Part 7





Removal Procedure	113
1. Indoor Unit.....	114
1.1 Removal of Air Filter / Front Panel	114
1.2 Removal of Front Grille	117
1.3 Removal of Electrical Box	120
1.4 Removal of PCB.....	127
1.5 Removal of Horizontal Blades (Louvers)/Vertical blades(Fins)/Swing Motors	135

1.6	Removal of Fan Motor.....	143
1.7	Removal of Heat Exchanger	146
1.8	Removal of Fan Rotor	150
2.	Outdoor Unit.....	152
2.1	Removal of Outer Panels	153
2.2	Removal of the Electrical Box	166
2.3	Removal of PCB.....	170
2.4	Removal of Fan Motor.....	173
2.5	Removal of Coils / Thermistors	174
2.6	Removal of Sound Blanket.....	177
2.7	Removal of Compressor.....	180
Part 8		
	Other Considerations	182
1.	Other Considerations	183
1.1	Trial Operation from the Remote Controller	183
1.2	Jumper Settings	184
1.3	Application of Silicon Grease to the Power Transistor and a Diode Bridge .	185
Part 9		
	Appendix.....	187
1.	Piping Diagrams.....	188
2.	Wiring Diagrams.....	189
Index	190
Drawings & Flow Charts	194

1. SAFETY CONSIDERATIONS

Read these **SAFETY CONSIDERATIONS** carefully before performing any repair work. Comply with these safety symbols without fail.

Meanings of **DANGER**, **WARNING**, **CAUTION**, and **NOTE** Symbols:

-  **DANGER** Indicates an imminently hazardous situation which, if not avoided, will result in death or serious injury.
-  **WARNING** Indicates a potentially hazardous situation which, if not avoided, could result in death or serious injury.
-  **CAUTION** Indicates a potentially hazardous situation which, if not avoided, may result in minor or moderate injury. It may also be used to alert against unsafe practices.
-  **NOTE** Indicates situations that may result in equipment or property-damage accidents only.

1.1 Safety Considerations for Repair

-  **DANGER** _____
- If refrigerant gas leaks during repair or service, ventilate the area immediately. Refrigerant gas may produce toxic gas if it comes into contact with flames. Refrigerant gas is heavier than air and replaces oxygen. In the event of an accident, a massive leak could lead to oxygen depletion, especially in basements, and an asphyxiator hazard could occur leading to serious injury or death.
- Do not start or stop the air conditioner operation by plugging or unplugging the power cable plug if a plug is used. Plugging or unplugging the power cable plug to operate the equipment may cause an electrical shock or fire.
- Use parts listed in the service parts list and appropriate tools to conduct repair work. The use of inappropriate parts or tools may cause an electrical shock or fire.
- Disconnect power before disassembling the equipment for repairs. Working on the equipment that is connected to the power supply may cause an electric shock. If it is necessary to supply power to the equipment to conduct repairs or to inspect the circuits, do not touch any electrically charged sections of the equipment.
- The step-up capacitor supplies high-voltage electricity to the electrical components of the outdoor unit. Discharge the capacitor completely before conducting repair work. A charged capacitor may cause an electrical shock.

- If refrigerant gas is discharged during repair work, do not touch the discharged refrigerant gas. The refrigerant gas may cause frostbite.
 - Use only pipes, flare nuts, tools, and other materials designed specifically for R410A refrigerant systems. Never use tools or materials designed for R22 refrigerant systems on an R410A refrigerant system. Doing so can cause a serious accident or an equipment failure.
 - Check to see if the parts and wires are mounted and connected properly, and if the connections at the soldered or crimped terminals are secure. Improper installation and connections may cause excessive heat generation, fire, or electrical shock.
-  **WARNING** _____
- Prior to disconnecting the suction or discharge pipe from the compressor at the welded section, pump-down the refrigerant gas completely in a well-ventilated place first. If there is refrigerant gas or oil remaining inside the compressor, the refrigerant gas or oil can discharge when the pipe is being disconnected and it may cause an injury.

- Wear a safety helmet, gloves, and a safety belt when working at an elevated height of more than 6.5 ft (2 m). Insufficient safety measures may cause a fall resulting in injury.
- Do not mix air or gas other than the specified refrigerant R410A to the refrigerant system. If air enters the refrigerant systems, it can cause an excessive high pressure resulting in equipment damage and injury.
- When relocating the equipment, check if the new installation site has sufficient strength to withstand the weight of the equipment. If the installation site does not have sufficient strength and the equipment is not properly secured, the equipment may fall and cause injury.
- Securely fasten the outside unit terminal cover (panel). If the terminal cover/panel is not fastened properly, dust or water may enter the outside unit causing fire or electric shock.
- When relocating the system, keep the refrigerant circuit free from substances other than the specified refrigerant (R-410A) such as air. Any presence of air or other foreign substance in the refrigerant circuit can cause an abnormal pressure rise or rupture, resulting in injury.
- If refrigerant gas leaks, locate the leaking point and repair it before charging refrigerant. After charging refrigerant, check for refrigerant leaks. If the leaking point cannot be located and the repair work must be stopped, perform a pump-down and close the service valve to prevent the refrigerant gas from leaking into the room. The refrigerant gas itself is harmless, but it

may generate toxic gases if it comes into contact with flames.



CAUTION

- Do not repair the electrical components with wet hands. Working on the equipment with wet hands may cause an electrical shock.
- Do not clean the air conditioner by splashing water on it. Washing the unit with water may cause an electrical shock.
- Ground the unit when repairing equipment in a humid or wet place to avoid electrical shocks.
- Turn off the power when cleaning the equipment to prevent internal fans that rotate at high speed from starting suddenly as they can cause injury.
- Let the refrigerant lines cool down before performing any repair work. Working on the unit when the refrigerant lines are hot may cause burns.
- All welding and cutting operations must be done in a well-ventilated place to prevent the accumulation of toxic fumes or possibly oxygen deficiency to occur.
- Check the grounding and repair it if the equipment is not properly grounded. Improper grounding may cause an electrical shock.
- Measure the insulation resistance after the repair. The resistance must be $1M\ \Omega$ or higher. Faulty insulation may cause an electrical shock.



NOTE

- Check the drainage of the indoor unit after finishing repair work. Faulty drainage may cause water to enter the room resulting in wet floors and furniture.
- Do not tilt the unit when removing it. The water inside the unit may spill resulting in wet floors and furniture.
- Dismantling of the unit, disposal of the refrigerant, oil, and additional parts, should be done in accordance with the relevant local, state, and national regulations.

1.2 Safety Considerations for Users



DANGER

- Never attempt to modify the equipment. Doing so can cause electrical shock, excessive heat generation, or fire.
- If the power cable and lead wires have scratches or have become deteriorated, have them replaced. Damaged cable and wires may cause an electrical shock or fire.

- Do not use a joined power cable or an extension cord, or share the same power outlet with other electrical appliances as it may cause an electrical shock or fire.

- Use an exclusive power circuit for the equipment. Insufficient circuit amperage capacity may cause an electrical shock or fire.



WARNING

- Do not damage or modify the power cable. Damaged or modified power cables may cause an electrical shock or fire. Placing heavy items on the power cable or pulling the power cable may damage the cable.
- Check the unit foundation for damage on a continual basis, especially if it has been in use for a long time. If left in a damaged condition, the unit may fall and cause injury. If the installation platform or frame has corroded, have it replaced. A corroded platform or frame may cause the unit to fall resulting in injury.
- If the unit has a power cable plug and it is dirty, clean the plug before securely inserting it into a power outlet. If the plug has a loose connection, tighten it or it may cause electrical shock or fire.



CAUTION

- After replacing the battery in the remote controller, dispose of the old battery to prevent children from swallowing it. If a child swallows the battery, see a doctor immediately.
- Never remove the fan guard of the unit. A fan rotating at high speed without the fan guard is very dangerous.
- Before cleaning the unit, stop the operation of the unit by turning the power off or by pulling the power cable plug out from its receptacle. Otherwise an electrical shock or injury may result.
- Do not wipe the controller operation panel with benzene, thinner, chemical dust cloth, etc. The panel may get discolored or the coating can peel off. If it is extremely dirty, soak a cloth in a water-diluted neutral detergent, squeeze it well, and wipe the panel clean. Then wipe it with another dry cloth.

Part 1

List of Functions

1. List of Functions2

1. List of Functions

Category	Functions	FTXS30/36HVJU RXS30/36HVJU	Category	Functions	FTXS30/36HVJU RXS30/36HVJU
Basic Function	Inverter (with Inverter Power Control)	○	Health & Air Cleaning	Air-Purifying Filter	—
	Operation Limit for Cooling (°FDB)	*(0)14~114.8		Photocatalytic Deodorizing Filter	—
	Operation Limit for Heating (°FWB)	5~75		Air-Purifying Filter with Photocatalytic Deodorizing Function	—
	PAM Control	○		Titanium Apatite Photocatalytic Air-Purifying Filter	○
Compressor	Oval Scroll Compressor	—		Air Filter (Pre-filter)	○
	Swing Compressor	○		Wipe-clean Flat Panel	○
	Rotary Compressor	—		Washable Grille	—
	Reluctance DC Motor	○		Mold Proof Operation	—
Comfortable Airflow	Power-Airflow Louvers	—	Timer	Heating Dry Operation	—
	Power-Airflow Dual Louvers	○		Good-Sleep Cooling Operation	—
	Power-Airflow Diffuser	—		Weekly Timer	○
	Wide-Angle Louvers	○		24-Hour ON/OFF Timer	○
	Vertical Auto-Swing (horizontal blades) Louvers (Up and Down)	○	Worry Free "Reliability & Durability"	Night Set Mode	○
	Horizontal Auto-Swing (vertical blades) Fins (Right and Left)	○		Auto-Restart (after Power Failure)	○
	3-D Airflow	○		Self-Diagnosis (Digital, LED) Display	○
	Comfort Airflow Mode	○		Wiring Error Check	—
Comfort Control	Auto Fan Speed	○	Flexibility	Anticorrosion Treatment of Outdoor Heat Exchanger	○
	Indoor Unit Quiet Operation	○		Multi-Split / Split Compatible Indoor Unit	—
	Night Quiet Mode (Automatic)	—		Flexible Voltage Correspondence	—
	Outdoor Unit Quiet Operation (Manual)	○		High Ceiling Application	—
	INTELLIGENT EYE	○		Chargeless	32ft
	Quick Warming Function	○		Either Side Drain (Right or Left)	○
	Hot-Start Function	○		Power Selection	—
	Automatic Defrosting	○		Low Temperature Cooling Operation (0°F / -17.7°C)*	○
Operation	Automatic Operation	○	Remote Control	°F/°C Changeover R/C Temperature Display (factory setting : °F)	○
	Program Dry Function	○		5-Rooms Centralized Controller (Option)	○
	Fan Only	○		Remote Control Adaptor (Normal Open-Pulse Contact) (Option)	○
Lifestyle Convenience	New POWERFUL Operation (Non-Inverter)	—	Remote Controller	Remote Control Adaptor (Normal Open Contact) (Option)	○
	Inverter POWERFUL Operation	○		DIII-NET Compatible (Adaptor) (Option)	○
	Priority-Room Setting	—		Wireless	○
	Cooling / Heating Mode Lock	—	Wired	○★	
	HOME LEAVE Operation	—			
	ECONO Mode	○			
	Indoor Unit ON/OFF Switch	○			
	Signal Reception Indicator	○			
	R/C with Back Light	○			
	Temperature Display	—			
Another Room Operation	—				

Note: ○ : Holding Functions
— : No Functions

★ : Option
* With optional Wind Baffle (KPW5E112)

Part 2 Specifications

1. Specifications4

1. Specifications

60Hz 208-230V

Models	Indoor Units		FTXS30HVJU		FTXS36HVJU	
	Outdoor Units		RXS30HVJU		RXS36HVJU	
			Cooling	Heating	Cooling	Heating
Capacity Rated (Min.-Max.)		kW	8.8 (3.0-8.8)	10.2 (3.0-10.2)	10.2-10.5 (3.0-10.2-10.5)	10.5-11.1 (3.0-10.5-11.1)
		Btu/h	30,000 (10,200-30,000)	34,800 (10,200-34,800)	35,000-36,000 (10,200-35,000-36,000)	36,000-38,000 (10,200-36,000-38,000)
		kcal/h	7,570 (2,580-7,570)	8,770 (2,580-8,770)	8,770-9,030 (2,580-8,770-9,030)	9,030-9,550 (2,580-9,030-9,550)
Running Current (Rated)		A	13.6-12.2	18.9-17.1	19.4-18.8	18.4-18.4
Power Consumption Rated (Min.-Max.)		W	2,800 (620-2,800)	3,900 (620-3,900)	4,000-4,300 (620-4,000-4,300)	3,800-4,200 (620-3,800-4,200)
Power Factor (Rated)		%	99.0-99.8	99.2-99.2	99.1-99.4	99.3-99.2
COP (Rated)		W/W	3.14 (4.84-3.14)	2.62 (4.84-2.62)	2.55-2.44 (4.84-2.55-2.44)	2.76-2.64 (4.84-2.76-2.64)
EER (Rated)		Btu/h-W	10.71 (16.45-10.71)	8.92 (16.45-8.92)	8.75-8.37 (16.45-8.75-8.37)	9.47-9.05 (16.45-9.47-9.05)
Energy Efficiency	SEER/HSPF		SEER 17	HSPF 8.3	SEER 16.2	HSPF 8.3
Piping Connections	Liquid	inch (mm)	ϕ3/8" (9.5 mm)		ϕ3/8" (9.5 mm)	
	Gas	inch (mm)	ϕ5/8" (15.8 mm)		ϕ5/8" (15.8 mm)	
	Drain	inch (mm)	ϕ 11/16" (17.5 mm)		ϕ 11/16" (17.5 mm)	
Heat Insulation			Both Liquid and Gas Pipes		Both Liquid and Gas Pipes	
Max. Interunit Piping Length		feet (m)	98.4' (30 m)		98.4' (30 m)	
Max. Interunit Height Difference		feet (m)	65.6' (20 m)		65.6' (20 m)	
Chargeless		feet (m)	32' (10 m)		32' (10 m)	
Amount of Additional Charge of Refrigerant		oz/ft	0.55		0.55	
Indoor Units			FTXS30HVJU		FTXS36HVJU	
Front Panel Color			White		White	
Airflow Rate	m /min (cfm)	H	20.0 (706)	20.1 (710)	21.8 (770)	22.9 (808)
		M	17.3 (611)	17.3 (611)	18.0 (635)	18.6 (657)
		L	14.7 (519)	14.7 (519)	14.7 (519)	14.7 (519)
		SL	13.4 (473)	13.3 (469)	13.4 (473)	13.3 (469)
Fan	Type		Cross Flow Fan		Cross Flow Fan	
	Motor Output	W	64		64	
	Speed	Steps	5 Steps, Quiet, Auto		5 Steps, Quiet, Auto	
Air Direction Control			Right, Left, Horizontal, Downward		Right, Left, Horizontal, Downward	
Air Filter			Removable / Washable / Mildew Proof		Removable / Washable / Mildew Proof	
Running Current (Rated)		A	0.38-0.34	0.38-0.34	0.38-0.34	0.38-0.34
Power Consumption (Rated)		W	77	77	77	77
Power Factor (Rated)		%	97.4-98.5	97.4-98.5	97.4-98.5	97.4-98.5
Temperature Control			Microcomputer Control		Microcomputer Control	
Dimensions (H W D)		in (mm)	13-3/8 47-1/4 9-7/16" (340 mm x 1200 x 240 mm)		13-3/8 47-1/4 9-7/16" (340 mm x 1200 x 240 mm)	
Packaged Dimensions (H W D)		in (mm)	12-13/16 51-9/16 16-7/8" (325 x 1310 x 429 mm)		12-13/16 51-9/16 16-7/8" (325 x 1310 x 429 mm)	
Weight		Lbs (kg)	38 lbs (17 kg)		38 lbs (17 kg)	
Gross Weight		Lbs (kg)	51 lbs (23 kg)		51 lbs (23 kg)	
Operation Sound	H/M/L/SL	dBA	47 / 45 / 40 / 37	47 / 44 / 38 / 35	49 / 45 / 40 / 37	49 / 44 / 38 / 35
Sound Power		dBA	63	63	65	65
Outdoor Units			RXS30HVJU		RXS36HVJU	
Casing Color			Ivory White		Ivory White	
Compressor	Type		Hermetically Sealed Swing Type		Hermetically Sealed Swing Type	
	Model		2YC63HxD		2YC63HxD	
	Motor Output	W	2,030		2,030	
Refrigerant Oil	Type		FVC50K		FVC50K	
	Charge	oz	25.5		25.5	
Refrigerant	Type		R-410A		R-410A	
	Charge	Lbs	6.17		6.17	
Airflow Rate	m /min (cfm)	HH	81.2 (2,867)	—	81.2 (2,867)	—
		H	74.4 (2,627)	74.4 (2,627)	74.4 (2,627)	74.4 (2,627)
		SL	65.6 (2,316)	65.6 (2,316)	65.6 (2,316)	65.6 (2,316)
Fan	Type		Propeller		Propeller	
	Motor Output	W	200		200	
Running Current (Rated)		A	13.22-11.86	18.52-16.76	19.02-18.46	18.02-18.06
Power Consumption (Rated)		W	2,723	3,823	3,923-4,223	3,723-4,123
Power Factor (Rated)		%	99.0-99.8	99.2-99.2	99.2-99.5	99.3-99.3
Starting Current		A	18.9		19.4	
Dimensions (H W D)		in (mm)	38-15/16 37 12-5/8" (989 x 940 x 321 mm)		38-15/16 37 12-5/8" (989 x 940 x 321 mm)	
Packaged Dimensions (H W D)		in (mm)	44-1/8 38 15-1/4" (1121 x 965 x 387 mm)		44-1/8 38 15-1/4" (1121 x 965 x 387 mm)	
Weight		Lbs (kg)	178 (81 kg)		178 (81 kg)	
Gross Weight		Lbs (kg)	198 (90 kg)		198 (90 kg)	
Operation Sound	H/SL	dBA	54 / 51	55 / 51	54 / 51	55 / 51
Sound Power	H	dBA	68	69	68	69
Drawing No.			3D063298A		3D063299A	

Note: ■ The data are based on the conditions shown in the table below.

Cooling	Heating	Piping Length
Indoor ; 80°FDB/67°F WB Outdoor ; 95°FDB/75°F WB	Indoor ; 70°FDB/60°F WB Outdoor ; 47°FDB/43°F WB	25ft (7.5 m)

Conversion Formulae
kcal/h=kW 860
Btu/h=kW 3414
cfm=m /min 35.3

Part 3 Printed Circuit Board Connector Wiring Diagram

1. Printed Circuit Board Connector Wiring Diagram.....	7
1.1 Indoor Unit.....	7
1.2 Outdoor Unit.....	9

1. Printed Circuit Board Connector Wiring Diagram

1.1 Indoor Unit

Connectors

PCB (1) (Control PCB)

- | | |
|--------|---|
| 1) S1 | Connector for DC fan motor |
| 2) S21 | Connector for centralized control (HA) |
| 3) S25 | Connector for INTELLIGENT EYE sensor |
| 4) S32 | Connector for heat exchanger thermistor |
| 5) S41 | Connector for swing motor |
| 6) S46 | Connector for display PCB |
| 7) S47 | Connector for signal receiver PCB |

PCB (2) (Signal Receiver PCB)

- | | |
|--------|---------------------------|
| 1) S48 | Connector for control PCB |
|--------|---------------------------|

PCB (3) (Display PCB)

- | | |
|--------|---------------------------|
| 1) S49 | Connector for control PCB |
|--------|---------------------------|



Note: Other designations

PCB (1) (Control PCB)

- | | |
|----------|--|
| 1) V1 | Varistor |
| 2) JA | Address setting jumper |
| JB | Fan speed setting when compressor is OFF on thermostat |
| JC | Power failure recovery function (auto-restart) |
| | * Refer to page 184 for detail. |
| 3) LED A | LED for service monitor (green) |
| 4) FU1 | Fuse (3.15A) |

PCB (3) (Display PCB)

- | | |
|---------------|----------------------------------|
| 1) SW1 (S1W) | Forced operation ON / OFF switch |
| 2) LED1 | LED for operation (green) |
| 3) LED2 | LED for timer (yellow) |
| 4) LED3 | LED for INTELLIGENT EYE (green) |
| 5) RTH1 (R1T) | Room temperature thermistor |

PCB Detail

PCB (1): Control PCB

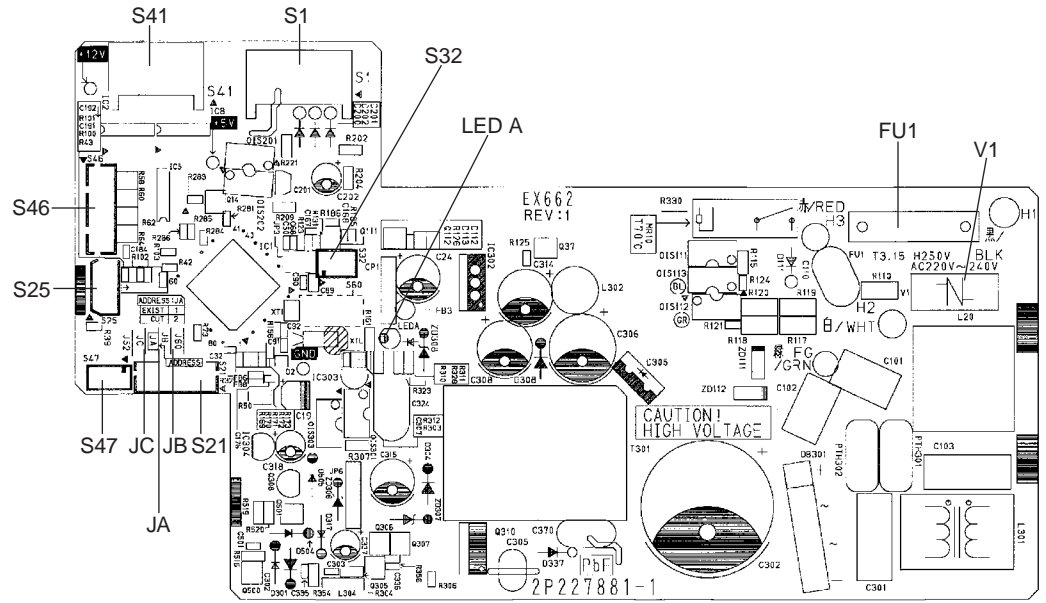

2P227881-1B

PCB (2): Signal Receiver PCB

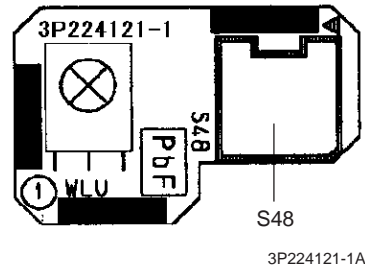

PCB (3): Display PCB

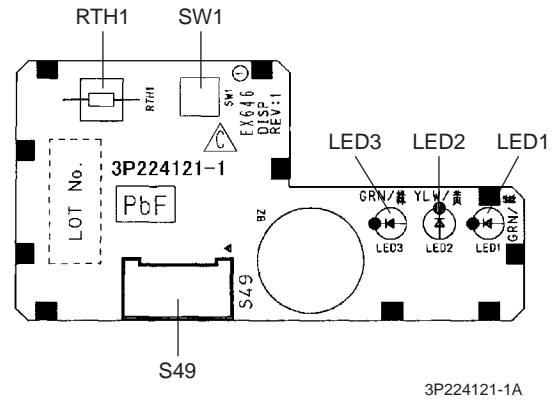

1.2 Outdoor Unit

Connectors

PCB (1) (Main PCB)

- | | |
|--------------|--|
| 1) S10 | Connector for terminal strip (indoor-outdoor transmission) |
| 2) S20 | Connector for electronic expansion valve coil |
| 3) S40 | Connector for overload protector |
| 4) S51, S101 | Connector for service monitor PCB |
| 5) S70 | Connector for fan motor |
| 6) S80 | Connector for four-way valve coil |
| 7) S90 | Connector for thermistors
(outdoor air, heat exchanger, discharge pipe) |
| 8) AC1, AC2 | Connector for terminal strip (power supply) |
| 9) HR1, HR2 | Connector for reactor |

PCB (2) (Service Monitor PCB)

- | | |
|--------------|---------------------------|
| 1) S52, S102 | Connector for control PCB |
|--------------|---------------------------|



Note:

Other Designations
PCB (1) (Main PCB)

- | | |
|-------------|--------------|
| 1) FU1 | Fuse (30A) |
| 2) FU2, FU3 | Fuse (3.15A) |

PCB (2) (Service Monitor PCB)

- | | |
|----------|--|
| 1) LED A | Service monitor LED (green) |
| 2) SW1 | Forced operation ON/OFF switch |
| 3) SW4 | Switch A : No function
Switch B : Facility setting switch
*Refer to page 42 for detail
Switch C : Defrost operation gets powerful |

PCB Detail

PCB (1): Main PCB

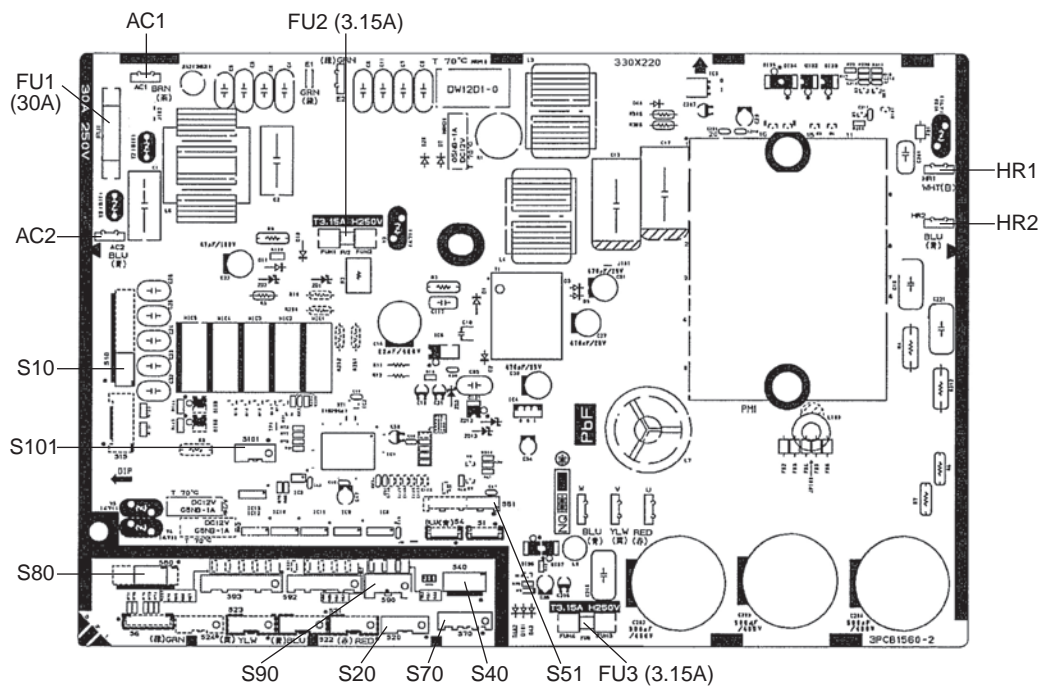

(R9653)

PCB (2): Service Monitor PCB

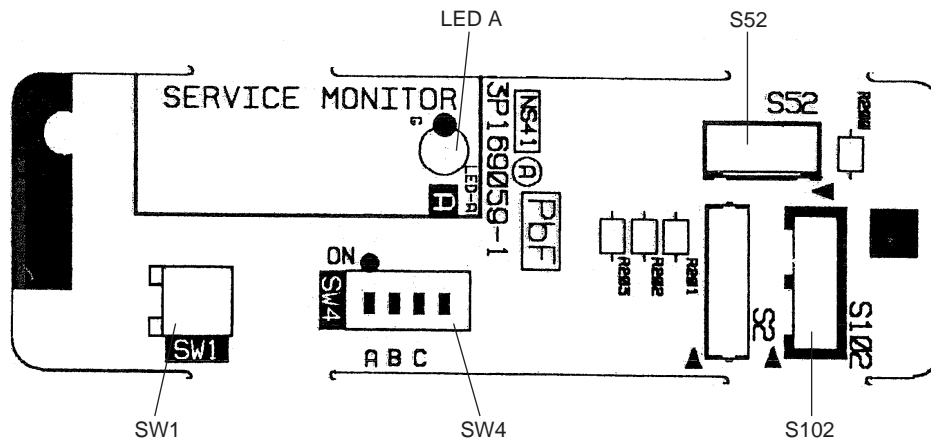

3P169059

Part 4

Function and Control

1. Main Functions	12
1.1 Frequency Principle.....	12
1.2 Airflow Direction Control.....	14
1.3 Fan Speed Control for Indoor Units.....	15
1.4 Program Dry Function	16
1.5 Automatic Operation.....	17
1.6 Thermostat Control.....	18
1.7 NIGHT SET Mode	19
1.8 ECONO Mode	20
1.9 INTELLIGENT EYE	21
1.10 Inverter POWERFUL Operation	23
1.11 Other Functions.....	24
2. Function of Thermistor	26
3. Control Specification	27
3.1 Mode Hierarchy	27
3.2 Frequency Control.....	28
3.3 Controls at Mode Changing / Start-up.....	30
3.4 Discharge PipeTemperature Control.....	32
3.5 Input Current Control.....	33
3.6 Freeze-up Protection Control	34
3.7 Fan Control.....	35
3.8 Liquid Compression Protection Function 2.....	35
3.9 Electronic Expansion Valve Control	37
3.10 Malfunctions	40
3.11 Forced Operation Mode	41
3.12 Additional Functions	41
3.13 Facility Setting Switch (cooling at low outdoor temperature).....	42

1. Main Functions

1.1 Frequency Principle

Main Control Parameters

The compressor is frequency-controlled during normal operation. The target frequency is set by the following 2 parameters coming from the operating indoor unit:

- The load condition of the operating indoor unit
- The difference between the room temperature and the set temperature

Additional Control Parameters

The target frequency is adapted by additional parameters in the following cases:

- Frequency restrictions
- Initial settings
- Forced cooling operation

Inverter Principle

To regulate the capacity, a frequency control is needed. The inverter makes it possible to vary the rotation speed of the compressor. The following table explains the conversion principle:

Phase	Description
1	The supplied AC power source is converted into a DC power source.
2	The DC power source is reconverted into a three-phase AC power source with variable frequency. <ul style="list-style-type: none"> ■ When the frequency increases, the rotation speed of the compressor increases resulting in increased refrigerant circulation. This leads to a higher amount of heat exchange per unit. ■ When the frequency decreases, the rotation speed of the compressor decreases resulting in decreased refrigerant circulation. This leads to a lower amount of heat exchange per unit.

Drawing of Inverter

The following drawing shows a schematic view of the inverter principle:

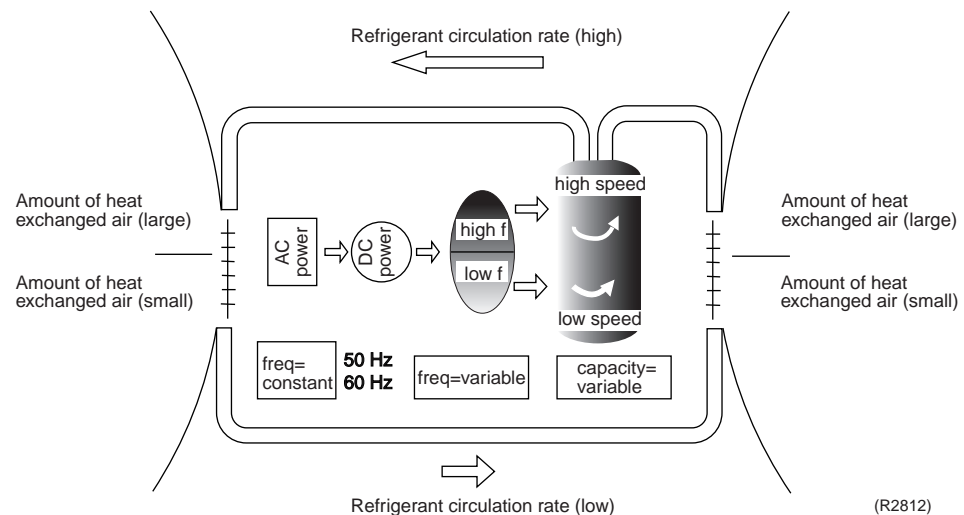

Inverter Features

The inverter provides the following features:

- The regulating capacity can be changed according to the changes in the outdoor air temperature and cooling / heating load.
- Quick heating and quick cooling.

The compressor rotational speed is increased when starting the heating (or cooling) operation. This enables a quick set temperature.

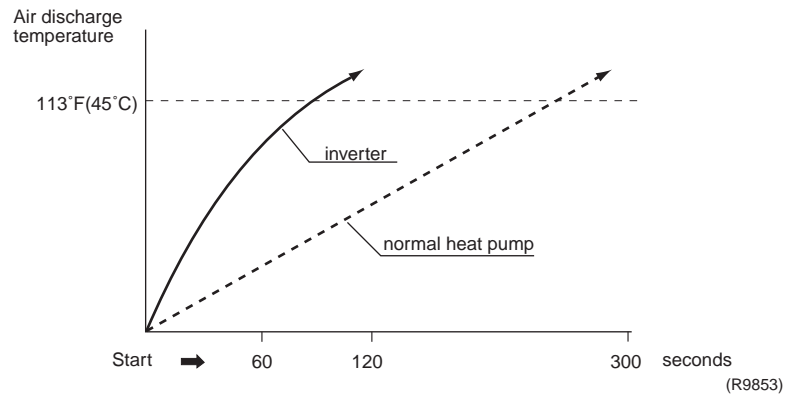

- Even during extreme cold weather, a high capacity is achieved. It is maintained even when the outdoor air temperature is 36°F(2°C).
- Comfortable air conditioning
A detailed adjustment is integrated to ensure a fixed room temperature. It is possible to air condition with a small room temperature variation.
- Energy saving heating and cooling
Once the set temperature is reached, the energy saving operation maintains the room temperature at low power.

Frequency Limits

The following table shows the functions that define the minimum and maximum frequency:

Frequency limits	Limited during the activation of following functions
Low	<ul style="list-style-type: none"> ■ Four-way valve operation compensation. Refer to page 31.
High	<ul style="list-style-type: none"> ■ Discharge pipe temperature control. Refer to page 36. ■ Input current control. Refer to page 33. ■ Compressor protection function. Refer to page 32. ■ Heating peak-cut control. Refer to page 34. ■ Freeze-up protection control. Refer to page 34. ■ Defrost control. Refer to page 35.

Forced Cooling Operation

For more information, refer to **Forced operation mode** on page 41.

1.2 Airflow Direction Control

Power-Airflow Dual Louvers

The large louvers send a large volume of air downwards to the floor. The louver provides an optimum control area in cooling, heating, and dry mode.

Heating Mode

During heating mode, the large louver directs warm air straight downward and across the floor to pervade the entire room.

Cooling / Dry Mode

During cooling or dry mode, the louver retracts into the indoor unit, allowing cool air to be blown across the whole room.

Wide-Angle Louvers

The louvers, made of elastic synthetic resin, provide a wide range of airflow that guarantees a comfortable air distribution.

Auto-Swing

The following table explains the auto swing process for heating, cooling, dry, and fan modes :

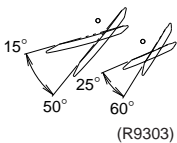
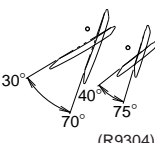
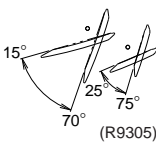
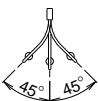
Louvers (horizontal blades) with Vertical Swing (up and down)			Fins (vertical blades) with Horizontal Swing (right and left)
Cooling / Dry	Heating	Fan	
			

3-D Airflow

- Alternative repetition of vertical and horizontal swing motions enables uniform airconditioning of the entire room. This function is effective when starting the air conditioner.
- When the horizontal swing and vertical swing are both set to auto mode, the airflow becomes 3-D airflow by alternating the horizontal vertical swing motions. The order of swing motion is such that it turns counterclockwise, starting from the right upper point as viewed from the front side of the indoor unit.

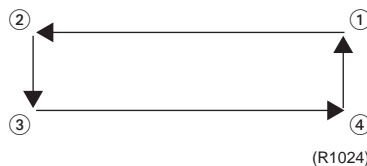

COMFORT AIRFLOW

The louver is controlled to avoid blowing air directly on people in the room.

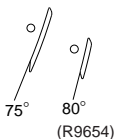
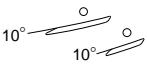
Heating	Cooling
	

1.3 Fan Speed Control for Indoor Units

Control Mode

The airflow rate can be automatically controlled depending on the difference between the set temperature and the room temperature. This is done through phase control and Hall IC control.



For more information about Hall IC, refer to the troubleshooting section, **Fan Motor (DC Motor) or Related Abnormality** on page 76.

Phase Steps

Phase control and fan speed control contains 9 steps: LLL, LL, SL, L, ML, M, MH, H and HH. In automatic fan speed operation, the step "SL" is not available.

Step	Cooling	Heating
LLL	 (R6833)	 (R6834)
LL		
L		
ML		
M		
MH		
H		
HH (POWERFUL)		

= The airflow rate is automatically controlled within this range when the FAN setting button is set to automatic.



Note:

1. During POWERFUL operation, fan operates H tap + 50 rpm.
2. Fan stops during defrost operation.
3. With the thermostat **OFF**, the fan rotates at the following speed.
 Cooling: The fan keeps rotating at the set tap.
 Heating: The fan stops.
 Dry: The fan stops after rotating for a few minutes at LL tap.

Automatic Airflow Control for Heating

In heating mode, the indoor fan speed will be regulated according to the indoor heat exchanger temperature and the difference between the room temperature and the required set point.

Automatic Airflow Control for Cooling

The following drawing explains the principle of fan speed control for cooling:

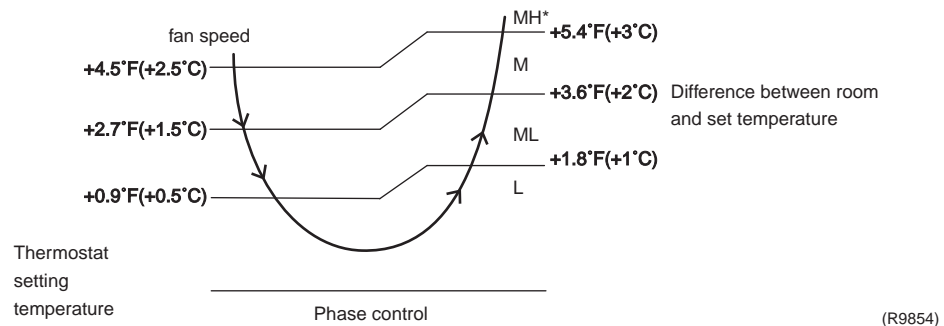

Note:

*: In automatic fan speed operation, upper limit is at M tap within 30 minutes from the operation start.

COMFORT AIRFLOW Mode

- The airflow rate is controlled automatically within the following steps.
 Cooling: L tap – MH tap (same as AUTOMATIC)
 Heating: L tap – M tap
- The latest command has the priority between POWERFUL and COMFORT AIRFLOW.

1.4 Program Dry Function

Program dry function removes humidity while preventing the room temperature from lowering. Since the microcomputer controls both the temperature and airflow volume, the temperature adjustment and fan adjustment buttons are inoperable in this mode.

In Case of Inverter Units

The microcomputer automatically sets the temperature and fan settings. The difference between the room temperature at startup and the temperature set by the microcomputer is divided into two zones. Then, the unit operates in the dry mode with an appropriate capacity for each zone to maintain the temperature and humidity at a comfortable level.

Room temperature at startup	Set temperature X	Thermostat OFF point Y	Thermostat ON point Z
75°F(24°C) or more	Room temperature at startup	$X - 4.5^{\circ}\text{F}$ ($X - 2.5^{\circ}\text{C}$)	$X - 0.9^{\circ}\text{F}(X - 0.5^{\circ}\text{C})$ or $Y + 0.9^{\circ}\text{F}(Y + 0.5^{\circ}\text{C},$ zone B) continues for 10 min.
74°F(23.5°C) 64°F(18°C)		$X - 3.6^{\circ}\text{F}$ ($X - 2.0^{\circ}\text{C}$)	$X - 0.9^{\circ}\text{F}(X - 0.5^{\circ}\text{C})$ or $Y + 0.9^{\circ}\text{F}(Y + 0.5^{\circ}\text{C},$ zone B) continues for 10 min.
63°F(17.5°C)	64°F(18°C)	$X - 3.6^{\circ}\text{F}$ ($X - 2.0^{\circ}\text{C}$)	$X - 0.9^{\circ}\text{F} = 63^{\circ}\text{F}$ ($X - 0.5^{\circ}\text{C} = 17.5^{\circ}\text{C}$) or $Y + 0.9^{\circ}\text{F}(Y + 0.5^{\circ}\text{C},$ zone B) continues for 10 min.

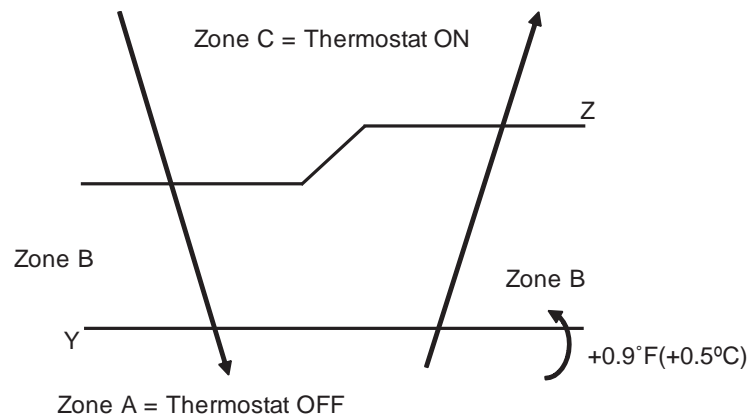

(R9855)

1.5 Automatic Operation

Automatic Cooling / Heating Function

When the AUTO mode is selected with the remote controller, the microcomputer automatically determines the operation mode from cooling and heating according to the room temperature and setting temperature at the time of operation startup, and automatically operates in that mode. The unit automatically switches the operation mode to cooling or heating to maintain the room temperature at the main unit setting temperature.

Detailed Explanation of the Function

1. Remote controller setting temperature is set as automatic cooling / heating setting temperature (64~86°F / 18~30°C).
2. Main unit setting temperature equals remote controller setting temperature.
3. Mode switching points are as follows.
 - ① Heating → Cooling switching point:
Room temperature \geq Main unit setting temperature +5.4°F(+3.0°C).
 - ② Cooling → Heating switching point:
Room temperature $<$ Main unit setting temperature -4.5°F(-2.5°C).
 - ③ Thermostat ON / OFF point is the same as the ON / OFF point of cooling or heating operation.
4. During initial operation
Room temperature \geq Remote controller setting temperature: Cooling operation
Room temperature $<$ Remote controller setting temperature: Heating operation

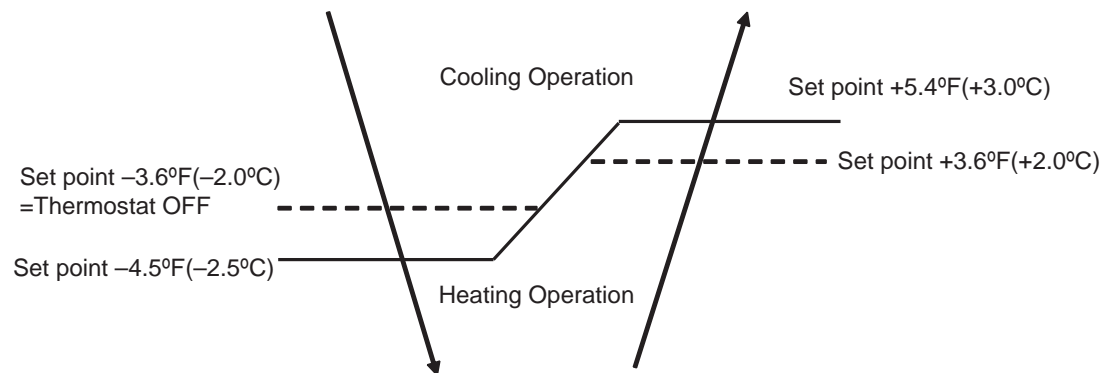

(R9856)

- Ex: When the set point is 77°F(25°C)
 Cooling Operation → 73.4°F(23°C): Thermostat OFF → 72.5°F(22.5°C):
 Switch to Heating Operation
 Heating Operation → 80.6°F(27°C): Thermostat OFF → 82.4°F(28°C):
 Switch to Cooling Operation

1.6 Thermostat Control

Thermostat control is based on the difference between the room temperature and the set point.

Thermostat OFF Condition

- ◆ The temperature difference is in zone A.

Thermostat ON Condition

- ◆ The temperature difference is above zone C after being in zone A.
- ◆ The system resumes from defrost control in any zones except A.
- ◆ The operation turns on in any zones except A.
- ◆ The monitoring time has passed while the temperature difference is in zone B.
(Cooling / Dry : 10 minutes, Heating : 10 seconds)

Cooling / Dry

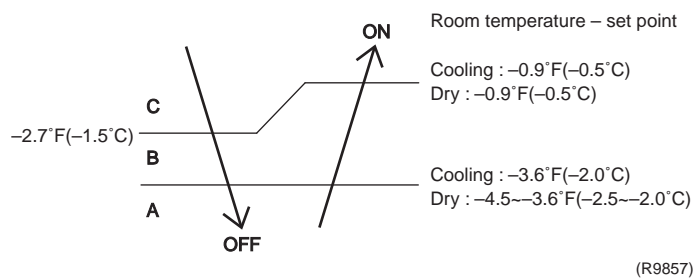

Heating

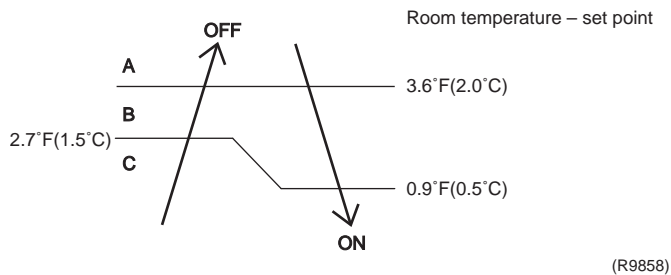

1.7 NIGHT SET Mode

When the OFF timer is set, the NIGHT SET circuit automatically activates. The NIGHT SET circuit maintains the airflow setting made by users.

The NIGHT SET Circuit

The NIGHT SET circuit continues heating or cooling the room at the set temperature for the first hour, then automatically raises the temperature setting slightly in the case of cooling, or lowers it slightly in the case of heating, for economical operations. This prevents excessive heating in winter and excessive cooling in summer to ensure comfortable sleeping conditions, and also conserves electricity.

Cooling Operation

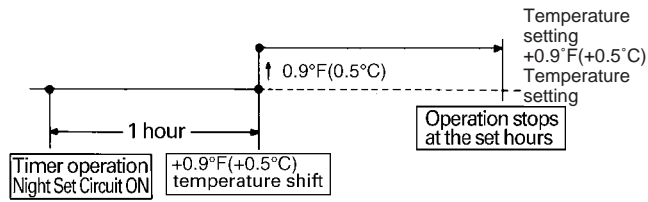

(R9859)

Heating Operation

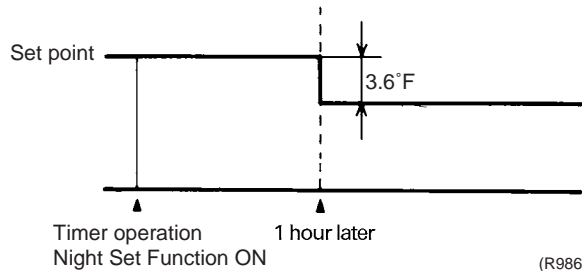

(R9860)

1.8 ECONO Mode

Outline

The **ECONO mode** is a function that sets a limit for power consumption. This mode is particularly convenient for energy-saving users. It is also a major bonus for those whose breaker capacities do not allow the use of multiple electrical devices and air conditioners. It is easily activated from the wireless remote controller by pushing the ECONO button.

- When this function is ON, the maximum capacity is also down.
- This function can only be set when the unit is running. Pressing the operation stop button causes the settings to be canceled.
- This function and POWERFUL operation cannot be used at the same time. The latest command has the priority.

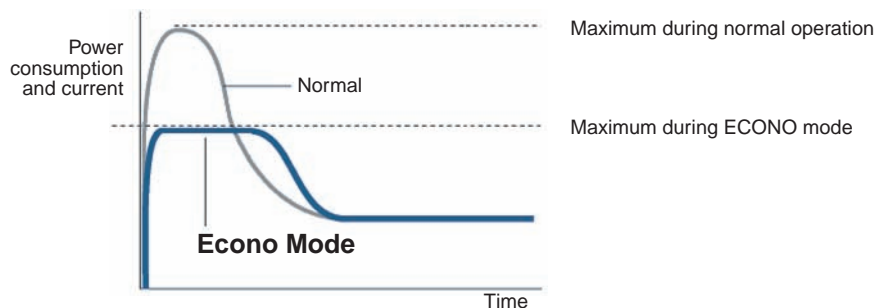

(R9288)

Details

- ECONO mode can be activated while the unit is running. The remote controller can send the ECONO command when the unit is in COOL, HEAT, DRY, or AUTO operation.
- When the ECONO command is valid, the power consumption is reduced.

Upper limit of power consumption

60Hz 208V/230V

R410A model	Cooling		Heating	
	Normal	ECONO	Normal	ECONO
FTXS30H	2800	1500	3900	1500
FTXS36H	4000/4300	2500	3800/4200	2500

(unit : W)

1.9 INTELLIGENT EYE

This function detects movement in the room by a human motion sensor (INTELLIGENT EYE), reducing capacity when the room is empty in order to save electricity.

Processing

1. Detection method by INTELLIGENT EYE

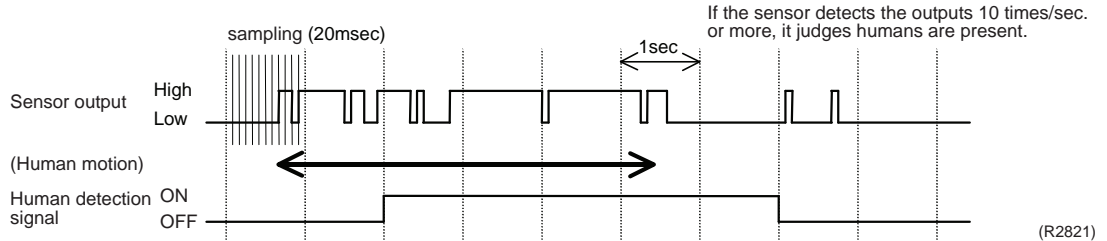

- This sensor detects motion by receiving infrared rays and displays the pulse wave output.
- A microcomputer in the indoor unit carries out a sampling every 20 msec. and if it detects 10 cycles of the wave in one second in total (corresponding to 20msec. $10 = 200\text{msec.}$), it determines there is movement in the room as the motion signal is ON.

2. The motions (for example: in cooling)

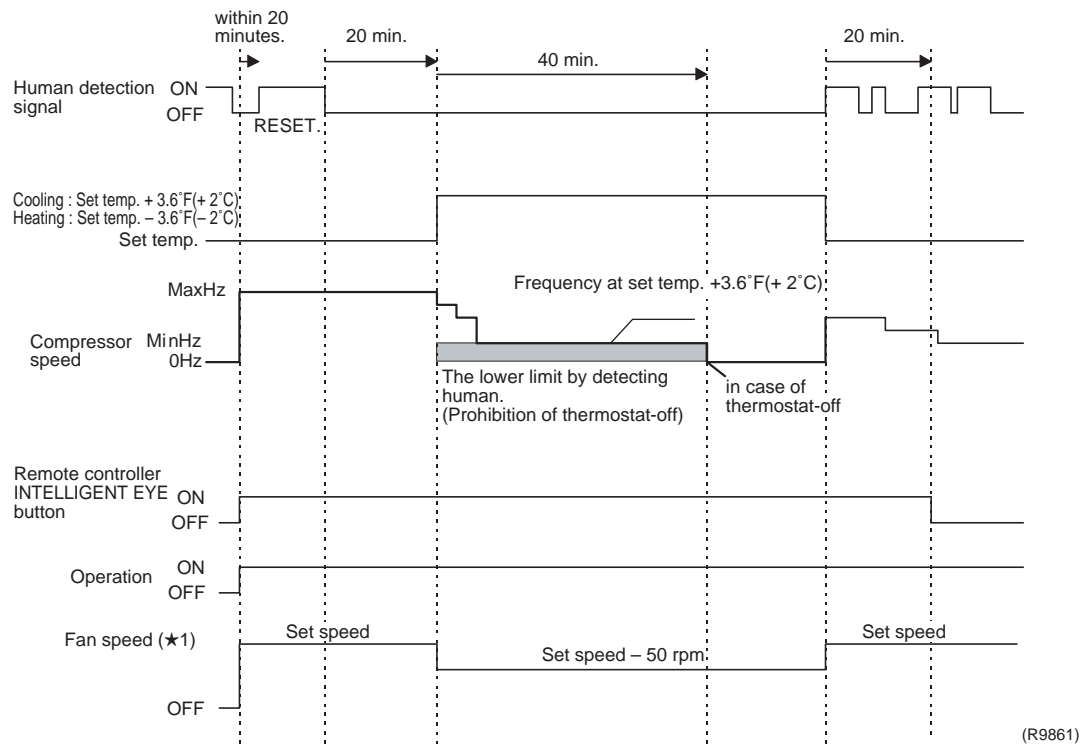

- When a microcomputer does not have a signal from the sensor in 20 minutes, it detects no presence is in the room and operates the unit at a temperature shifted 3.6°F(2°C) from the set temperature. (Cooling/Dry : 3.6°F(2°C) higher, Heating: 3.6°F(2°C) lower and Auto : according to the operation mode at that time.)

★1 In case of Fan mode, the fan speed reduces by 50 rpm.

- Since the set temperature is shifted by 3.6°F (2°C) higher for 40 minutes, the compressor speed lowers to save energy. The thermostat goes off due to the shifting of temperature so the thermostat-off action is prohibited for 40 minutes to prevent this phenomena. After this 40 minutes, the prohibition of the thermostat-off is cancelled and it resumes conditions to conduct thermostat-off, depending on the room temperature. In or after this 40 minutes, if the sensor detects the human-motion detection signal, it allows the set temperature and the fan speed to return to the original set point, maintaining normal operation.

Others

- The dry operation cannot command the setting temperature with a remote controller, but internally the set temperature is shifted by 1.8°F(1°C).

1.10 Inverter POWERFUL Operation

Outline

To optimize the cooling and heating capacity, operate the air conditioner by increasing the indoor fan rotating speed and the compressor frequency.

Details of the Control

When the POWERFUL button is pushed in each operation mode, the fan speed / setting temperature will be converted to the following states in a period of 20 minutes.

Operation mode	Fan speed	Target set temperature
COOL	H tap + 50 rpm	64°F(18°C)
DRY	Dry rotating speed + 50 rpm	Normally targeted temperature in dry operation; Approx. -3.6°F(-2°C)
HEAT	H tap + 50 rpm	86°F(30°C)
FAN	H tap + 50 rpm	—
AUTO	Same as cooling / heating in POWERFUL operation	The target is kept unchanged

Ex.) : POWERFUL operation in cooling mode.

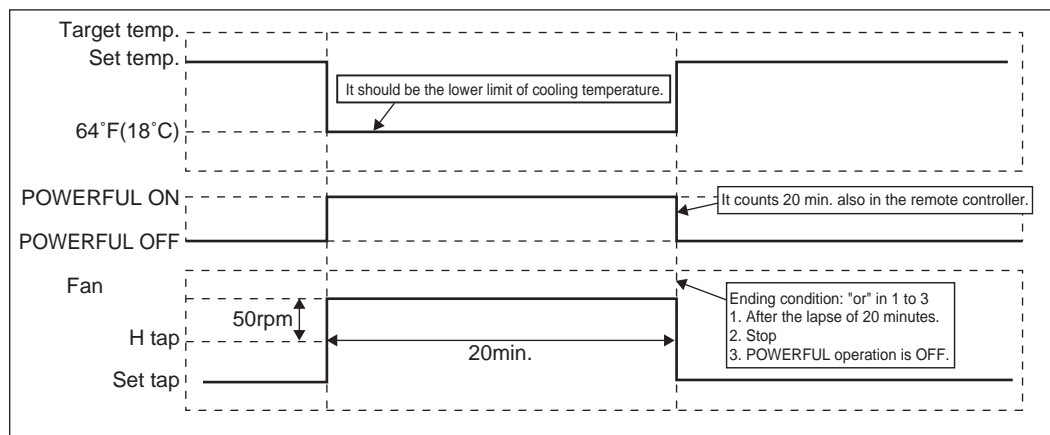

(R9862)

1.11 Other Functions

1.11.1 Hot Start Function

In order to prevent the cold air blast that normally comes when heating is started, the temperature of the heat exchanger in the indoor unit is detected, and either the airflow stops or lowers to ensure comfortable heating of the room.

*The cold air blast is also prevented using a similar control when the defrosting operation is started or when the thermostat gets turned ON.

1.11.2 Signal Receiving Sign

When the indoor unit receives a signal from the remote controller, the unit emits a signal (beep) receiving sound.

1.11.3 ON/OFF Button on Indoor Unit

An ON/OFF button is provided on the front panel of the unit. Use this button when the remote controller is missing or if its battery is dead.

Every press of the button switches from ON to OFF or from OFF to ON.

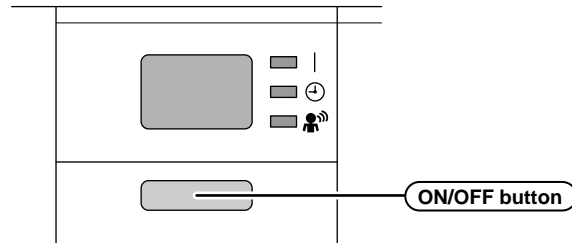

(R9311)

- Push this button once to start operation. Push once again to stop it.
- This button is useful when the remote controller is missing.
- The operation mode refers to the following table:

	Mode	Temperature setting	Airflow rate
Heat Pump	AUTO	77°F(25°C)	AUTO

<Forced operation mode>

Forced operation mode is set by pressing the ON/OFF button for between 5 to 9 sec. while the unit is not operating.

See page 41 for the detail of "**Forced Operation Mode**".



Note: When the ON/OFF button is pressed for 10 seconds. or more, the operation will be stopped.

1.11.4 Titanium Apatite Photocatalytic Air-Purifying Filter

This filter combines the Air Purifying Filter and Titanium Apatite Photocatalytic Deodorizing Filter in a single highly effective unit. The filter traps microscopic particles, decomposes odors and even deactivates bacteria and viruses. It lasts for 3 years without replacement if washed once every 6 months.

1.11.5 Air Filter (Prefilter)

The air filter material is permeated with a safe, odorless mold preventative to make the filter virtually immune to mold.

1.11.6 Auto-restart Function

Even if a power failure (including one for just a moment) occurs during operation, it automatically restarts in the mode existing prior to power failure as soon as power is restored.

(Note) It takes 3 minutes to restart the operation because the 3-minute standby function is activated.

1.11.7 WEEKLY TIMER Operation

Up to 4 timer settings can be saved for each day of the week (up to 28 settings in total).
ON / OFF, Temperature and Time items can be set.



Refer to ***WEEKLY TIMER Operation*** on page 60 for detail.

2. Function of Thermistor

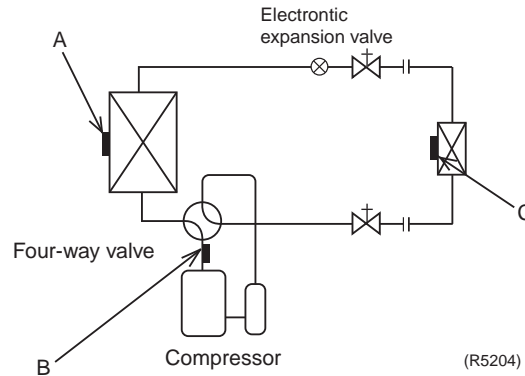

A Outdoor Heat Exchanger Thermistor

1. The outdoor heat exchanger thermistor is used for controlling target discharge temperature. The system sets a target discharge temperature according to the outdoor and indoor heat exchanger temperature, and controls the electronic expansion valve opening so that the target discharge temperature can be obtained.
2. The outdoor heat exchanger thermistor is used for detecting disconnection of the discharge thermistor when cooling.
When the discharge pipe temperature becomes lower than the outdoor heat exchanger temperature, the discharge pipe thermistor is judged as disconnected.
3. The outdoor heat exchanger thermistor is used for high pressure protection during cooling operation.

B Discharge Pipe Thermistor

1. The discharge pipe thermistor is used for controlling the temperature of the discharge pipe. If the temperature of the discharge pipe (used in place of the inner temperature of the compressor) rises abnormally, the operating frequency drops or the operation halts.
2. The discharge pipe thermistor is used for detecting disconnection of the discharge thermistor.

C Indoor Heat Exchanger Thermistor

1. The indoor heat exchanger thermistor is used for controlling target discharge temperature. The system sets a target discharge pipe temperature according to the outdoor and indoor heat exchanger temperature, and controls the electronic expansion valve opening so that the target discharge temperature can be obtained.
2. The indoor heat exchanger thermistor is used for preventing freezing.
During the cooling operation, if the temperature drops abnormally, the operating frequency lowers, then the operation halts.
3. During heating: the indoor heat exchanger thermistor is used for detecting disconnection of the discharge pipe thermistor.
When the discharge pipe temperature becomes lower than the indoor heat exchanger temperature, the discharge pipe thermistor is judged as disconnected.
The indoor heat exchanger thermistor is also used for preventing abnormal high pressure.

3. Control Specification

3.1 Mode Hierarchy

Outline

There are two modes; the mode selected by the user (normal air conditioning mode) and forced operation mode for installing and servicing.

Detail

1. For heat pump model

Modes available are **stop**, **cooling** (includes drying), and **heating** (includes defrosting)

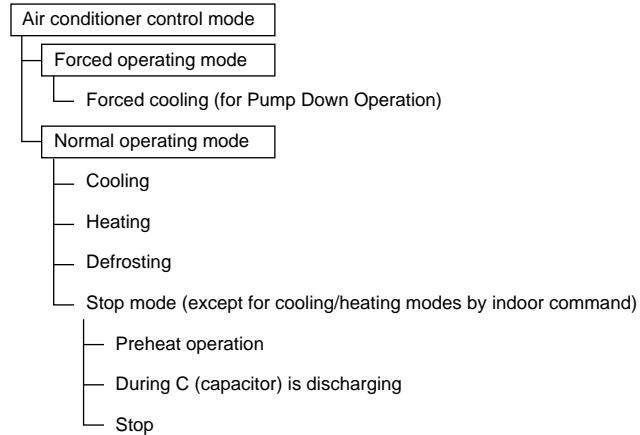

(R2829)



Note: Unless specified otherwise, an indoor dry operation command must be regarded as cooling operation.

3.2 Frequency Control

Outline

Frequency will be determined according to the difference between room and set temperature. The function is explained as follows.

1. How to determine frequency.
2. Frequency command from an indoor unit. The difference between a room temperature and the temperature set by the remote controller.
3. Frequency command from an indoor unit.
4. Frequency initial setting.
5. PI control.

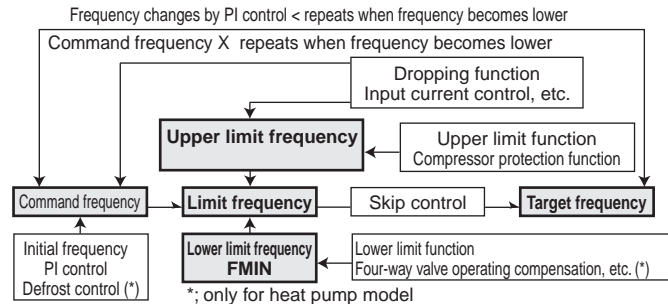

(R2831)

Detail

How to Determine Frequency

The compressor's frequency is determined by taking the following steps:

For Heat Pump Model

1. Determine command frequency

- ◆ Command frequency will be determined in the following order of priority.
 - 1.1 Limiting frequency by dropping function
 - ◆ Input current, discharge pipes, low Hz high pressure limit, peak cutting, freeze prevention, dew prevention, fin thermistor temperature.
 - 1.2 Limiting defrost control time
 - 1.3 Forced cooling
 - 1.4 Indoor frequency command

2. Determine upper limit frequency

- ◆ Set a minimum value as an upper limit frequency among the frequency upper limits of the following functions:
Compressor protection, input current, discharge pipes, Low Hz high pressure, peak cutting, freeze prevention, defrost.

3. Determine lower limit frequency

- ◆ Set a maximum value as a lower limit frequency among the frequency lower limits of the following functions:
Four-way valve operating compensation, draft prevention, pressure difference stabilization.

4. Determine prohibited frequency

- ◆ There is a certain prohibited frequency such as a power supply frequency.

Indoor Frequency Command (ΔD signal)

The difference between the room temperature and the temperature set by the remote controller will be taken as the " ΔD signal" and is used for frequency command.

Temperature difference °F(°C)	ΔD signal	Temperature difference °F(°C)	ΔD signal	Temperature difference °F(°C)	ΔD signal	Temperature difference °F(°C)	ΔD signal
0	*Th OFF	3.6 (2.0)	4	7.2 (4.0)	8	10.8 (6.0)	C
0.9 (0.5)	1	4.5 (2.5)	5	8.1 (4.5)	9	11.7 (6.5)	D
1.8 (1.0)	2	5.4 (3.0)	6	9.0 (5.0)	A	12.6 (7.0)	E
2.7 (1.5)	3	6.3 (3.5)	7	9.8 (5.5)	B	13.5 (7.5)	F

*Th OFF = Thermostat OFF

Frequency Initial Setting**<Outline>**

When starting the compressor, or when conditions are varied due to the change of the room, the frequency must be initialized according to the total of a maximum ΔD value of the indoor unit and the Q value of the indoor unit.

Q value: Indoor unit output determined from indoor unit volume, airflow rate and other factors.

PI Control (Determine Frequency Up/Down by ΔD Signal)**1. P control**

Calculate ΔD value in each sampling time (20 seconds), and adjust the frequency according to its difference from the frequency previously calculated.

2. I control

If the operating frequency is not changed more than a certain fixed time, adjust the frequency up and down according to the ΔD value, obtaining the fixed ΔD value.

When the ΔD value is small...lower the frequency.

When the ΔD value is large...increase the frequency.

3. Limit of frequency variation width

When the difference between input current and input current dropping value is less than 1.0 A, the frequency increase width must be limited.

4. Frequency management when other controls are functioning

- ◆ When frequency is dropping;
Frequency management is carried out only when the frequency drops.
- ◆ For limiting lower limit
Frequency management is carried out only when the frequency rises.

5. Upper and lower limit of frequency by PI control

The frequency upper and lower limits are set depending on indoor unit.

When low noise commands come from the indoor unit or when outdoor unit low noise or quiet commands come from indoor unit, the upper limit frequency must be lower than the usual setting.

3.3 Controls at Mode Changing / Start-up

3.3.1 Preheating Operation

Outline Operate the inverter in the open phase operation with conditions including the preheating command, outdoor air temperature, and discharge pipe temperature from the indoor side.

Detail Outside temperature $\geq 50^{\circ}\text{F}(10^{\circ}\text{C})$ → Control A (preheating for normal state)
Outside temperature $< 50^{\circ}\text{F}(10^{\circ}\text{C})$ → Control B (preheating of increased capacity)

Control A

- ◆ ON condition
 - Discharge pipe temperature $< 42.8^{\circ}\text{F}(6^{\circ}\text{C})$
 - Fin temperature $< 185^{\circ}\text{F}(85^{\circ}\text{C})$
- ◆ OFF condition
 - Discharge pipe temperature $> 46.4^{\circ}\text{F}(8^{\circ}\text{C})$
 - Fin temperature $\geq 194^{\circ}\text{F}(90^{\circ}\text{C})$

Control B

- ◆ ON condition
 - Discharge pipe temperature $< 50.9^{\circ}\text{F}(10.5^{\circ}\text{C})$
 - Fin temperature $< 185^{\circ}\text{F}(85^{\circ}\text{C})$
- ◆ OFF condition
 - Discharge pipe temperature $> 53.6^{\circ}\text{F}(12^{\circ}\text{C})$
 - Fin temperature $\geq 194^{\circ}\text{F}(90^{\circ}\text{C})$



Note: The power consumption of compressor during preheat operation is 35 W.

3.3.2 Four-Way Valve Switching

Outline During the heating operation, current must be conducted and during cooling and defrosting, current must not be conducted. In order to eliminate the switching sound (as the four-way valve coil switches from ON to OFF) when the heating is stopped, the delay switch of the four-way valve must be carried out after the operation stopped.

Detail The OFF delay of four-way valve
Energize the coil for 150 seconds after unit operation is stopped.

3.3.3 Four-Way Valve Operation Compensation

Outline At the beginning of the operation as the four-way valve is switched, acquire the differential pressure required for activating the four-way valve by the operating frequency output, which is more than a certain fixed frequency, for a certain fixed time.

Detail **Starting Conditions**

1. The MRC/W turns ON when the compressor starts for heating after the MRC/W has been OFF with compressor halted.
2. The MRC/W turns OFF when the compressor starts for cooling after the MRC/W has been ON with compressor running.
3. The compressor starts for the first time after reset.
4. The compressor starts after suspension caused by the trouble of cooling/heating changeover. Set the lower limit frequency (cooling : A Hz, heating : B Hz) for C seconds with any conditions 1 through 4 above.

		30/36 class
Compensation frequency in cooling	A	(-6 DOA) / 256 + 9679 / 256 DOA: Outdoor Temp (°C).
Compensation frequency in heating	B	
Compensation timer	C	70

3.3.4 3-Minute Standby

Prohibits turning ON the compressor for 3 minutes after turning it off.
(Except when defrosting.)

3.3.5 Compressor Protection Function

When turning the compressor from OFF to ON, the upper limit of frequency must be set as follows. The function must not be used when defrosting.

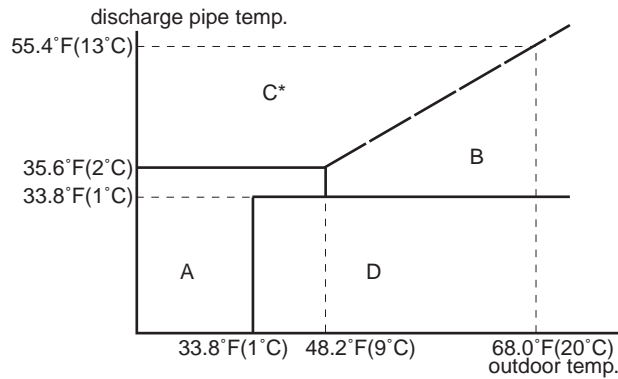

(R9863)

C*: Within 1 hour after power ON, the values are same as in the zone-A.

	zone-A	zone-B	zone-C	zone-D
FCG 1	46	46	55	46
FCG 2	65	65	65	65
FCG 3	80	80	80	80
TCG 1	500	500	120	500
TCG 2	180	100	200	180
TCG 3	470	470	470	470

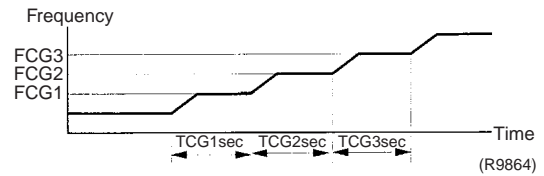

(R9864)

3.4 Discharge Pipe Temperature Control

Outline

The discharge pipe temperature is used as the compressor's internal temperature. If the discharge pipe temperature rises above a certain level, the operating frequency upper limit is set to keep this temperature from going up further.

Detail

Divide the Zone

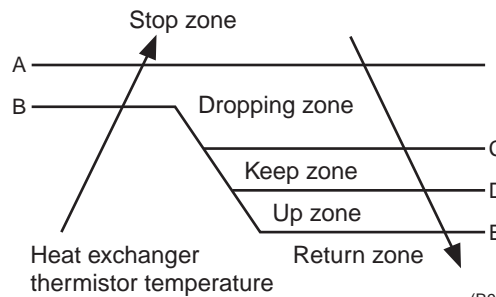

	30/36 class
A	248°F(120°C)
B	232°F(111°C)
C	228°F(109°C)
D	225°F(107°C)
E	225°F(107°C)

(R9865)

Management within the Zones

Zone	Control contents
Stop zone	When the temperature reaches the stop zone, stop the compressor and correct abnormality.
Dropping zone	Start the timer, and the frequency is dropping.
Keep zone	Keep the upper limit of frequency.
Return zone	Cancel the upper limit of frequency.

3.5 Input Current Control

Outline

The microcomputer calculates the input current while the compressor is running, and sets the frequency upper limit from such input current.

In case of heat pump model, this control is the upper limit control function of the frequency which takes priority of the lower limit of four-way valve activating compensation.

Detail

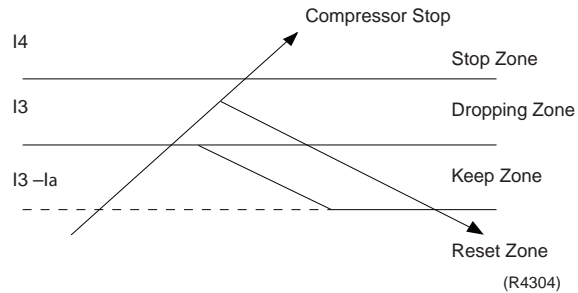

Frequency control in each zone

Dropping zone

- ♦ The maximum limit of the compressor frequency in this control is defined as operation frequency – 2Hz.
- ♦ After this, the output frequency is pulled down by 2Hz every second until it reaches the steady zone.

Keep zone

- ♦ The present maximum frequency goes on.

Reset zone

- ♦ Limit of the frequency is cancelled.

Stop zone

- ♦ After 2.5 seconds in this zone, the compressor is stopped.

	Cooling	Heating
I4 (A)	20	20
I3 (A)	19	19
I3-la (A)	18	18

Limitation of current dropping and stop value according to the outdoor air temperature

1. In case the operation mode is cooling
 - ♦ The current drops when outdoor air temperature becomes higher than a certain level (model by model).
2. In case the operation mode is heating
 - ♦ The current drops when outdoor air temperature becomes higher than a certain level (model by model).

3.6 Freeze-up Protection Control

Outline During cooling operation, the signals being sent from the indoor unit allow the operating frequency limitation and then prevent freezing of the indoor heat exchanger. The signal from the indoor unit must be divided into the zones as shown in the following diagram:

Detail **Conditions for Start Controlling**
 Judge the controlling start with the indoor heat exchanger temperature after 2 seconds from operation start.

Control in Each Zone Heating Peak-cut Control

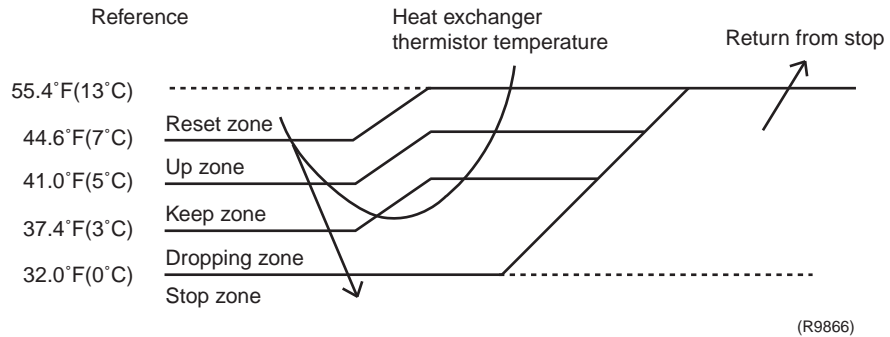

(R9866)

3.7 Heating Peak-Cut Control

Outline During heating operation, the signals being sent from the indoor unit allow the operating frequency limitation and prevent abnormal high pressure. The signal from the indoor unit must be divided as follows:

Detail **Conditions for Start Controlling**
 Judge the controlling start with the indoor heat exchanger temperature.

Control in Each Zone

The heat exchanger's intermediate indoor unit temperature controls the following:

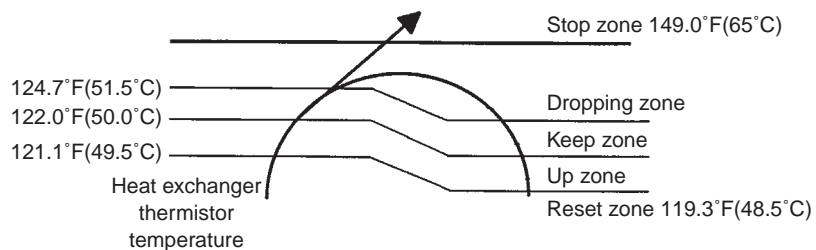

(R9867)

3.8 Fan Control

- Outline** Fan control is carried out according to the following conditions.
1. Fan ON control for electric component cooling fan
 2. Fan control when defrosting
 3. Fan OFF delay when stopped
 4. Fan control for maintaining pressure difference
 5. Fan control when the compressor starts for heating
 6. Fan control in forced operation
 7. Fan control in POWERFUL mode
 8. Fan control in low noise operation
 9. Fan control in quiet mode
-

- Detail** **Outdoor Unit Fan OFF Control when Stopped**
- ◆ Fan OFF delay for 60 seconds must be made when the compressor is stopped

3.9 Liquid Compression Protection Function 2

- Outline** In order to ensure the dependability of the compressor, the compressor must be stopped according to the conditions of the temperature of the outdoor air and outdoor heat exchanger.
-

- Detail**
- ◆ Operation stops depending on the outdoor air temperature
- Compressor operation turns OFF under the conditions that the system is in cooling operation and outdoor air temperature is below 10.4°F(-12°C).
- NOTE:** See Page 42 for low-ambient cooling operation setting.
-

3.10 Defrost Control

- Outline** Defrosting is carried out by the cooling cycle (reverse cycle). The defrosting time or outdoor heat exchanger temperature must be more than its fixed value when finishing.
-

- Detail** **Conditions for Starting Defrost**

Certain conditions must exist when starting the defrost operation. The heat exchanger must be in heating operation, 6 minutes should elapse after the compressor is started, and more than 38 minutes of accumulated time should pass after the start of operation or ending of the last defrosting operation.

Conditions for Canceling Defrost

The judgment must be made with heat exchanger temperature.
(39.2~64.4°F / 4~18°C)

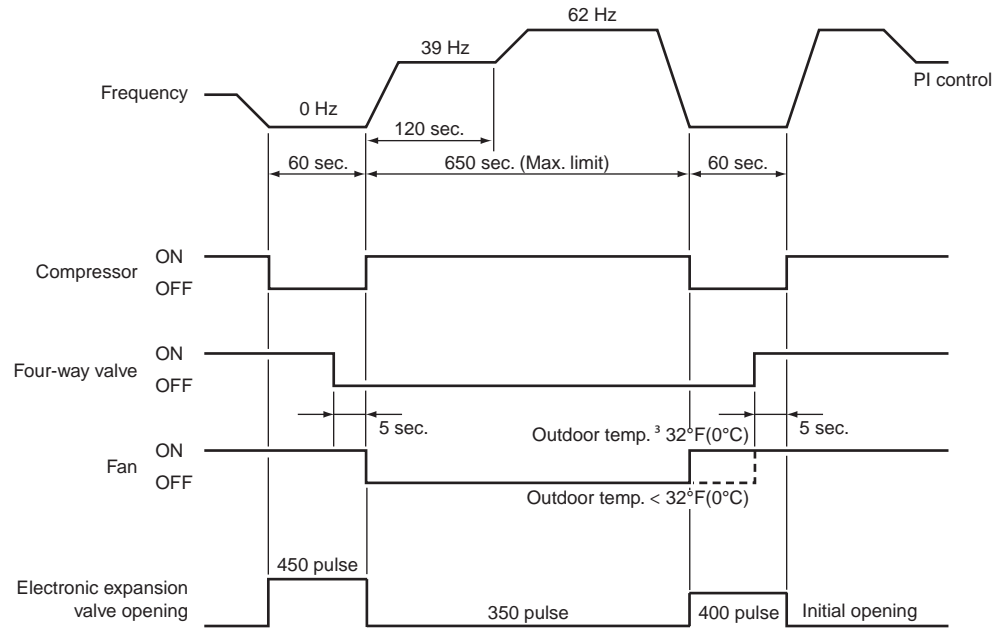

(R9868)

3.11 Electronic Expansion Valve Control

Outline

The following are control examples that function in each mode with the electronic expansion valve control:

Electronic expansion valve is fully closed

1. Electronic expansion valve is fully closed when turning on the power.
2. Pressure equalizing control

Open Control

1. Electronic expansion valve control when starting operation
2. Control when frequency changes
3. Control for defrosting
4. Control when a discharge pipe temperature is abnormally high
5. Control when the discharge pipe thermistor is disconnected

Detail

Feedback Control

1. Discharge pipe temperature control

Operation pattern	○ : function × : not function	Control when frequency changed	Control for abnormally high discharge pipe temperature
When power is turned ON	Fully closed when power is turned ON	×	×
↓	Cooling operation	×	○
↓	(Control of target discharge pipe temperature)	○	○
↓	Stop	×	×
↓	Heating operation	×	○
↓	(Control of target discharge pipe temperature)	○	○
↓	(Defrost control FD=1)	×	×
↓	Stop	×	×
↓	Heating operation	×	○
↓	Control of discharge pipe thermistor disconnection	↓	↓
↓	Continue	×	×
↓	Stop	×	×
↓	Pressure equalizing control	×	×

(R2833)

3.11.1 Fully Closed with Power ON

Initialize the electronic expansion valve when turning on the power, set the opening position and develop pressure equalizing.

3.11.2 Pressure Equalization Control

When the compressor is stopped, open and close the electronic expansion valve and develop pressure equalization.

3.11.3 Opening Limit

Outline

Limit a maximum and minimum opening of the electronic expansion valve.

Detail

- ◆ Maximum opening : 480 pulses
 - ◆ Minimum opening : 10 pulses
- The electronic expansion valve is fully closed in the room where cooling is stopped and is opened with fixed opening during defrosting.

3.11.4 Starting Operation Control

Control the electronic expansion valve opening when the system is starting, and prevent the system from being super heated or producing condensation.

3.11.5 High Temperature of the Discharge Pipe

When the compressor is operating, if the discharge pipe temperature exceeds a certain value, open the electronic expansion valve and remove the refrigerant from the low pressure side and lower discharge temperature.

3.11.6 Disconnection of the Discharge Pipe Thermistor

Outline

Disconnection of the discharge pipe thermistor is detected by comparing the discharge pipe temperature with the heat exchanger temperature. If any are disconnected, open the electronic expansion valve according to the outdoor air temperature and the operating frequency, operate for 9 minutes, and then stop.

After 3 minutes of waiting, the compressor restarts and the same process is carried out again. If the disconnection is detected 4 times in succession, then the system will be shut down.

When the compressor runs for 60 minutes without any error, the error counter will reset itself.

Detail

Detect Disconnection

When the timer for open control (630 sec.) is over, and the 9-minute timer for the compressor operation continuation is not counting time, the following adjustment must be made.

1. When the operation mode is cooling:
 - When the following condition is fulfilled, the discharge pipe thermistor disconnection is ascertained.
 - Discharge pipe temperature +10.8°F(+6°C) < outdoor heat exchanger temperature
2. When the operation mode is heating:
 - When the following condition is fulfilled, the discharge pipe thermistor disconnection is ascertained.
 - Discharge pipe temperature +10.8°F(+6°C) < indoor heat exchanger temperature

3.11.7 Control when frequency is changed

When the target discharge pipe temperature control is active, if the target frequency is changed for a specified value in a certain time period, cancel the target discharge pipe temperature control and change the target opening of the electronic expansion valve according to the shift.

3.11.8 Target Discharge Pipe Temperature Control

Obtain the target discharge pipe temperature from the indoor and outdoor heat exchanger temperature, and adjust the electronic expansion valve opening so that the actual discharge pipe temperature becomes close to that temperature. (Indirect SH control using the discharge pipe temperature)

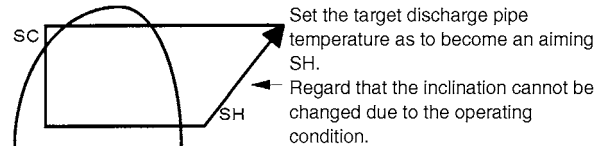

(R1389)

Determine a correction value of the electronic expansion valve compensation and drive it according to the deflection of the target discharge temperature and actual discharge temperature, and the discharge temperature variation by 20 seconds.

3.12 Malfunctions

3.12.1 Sensor Malfunction Detection

Sensor malfunction may occur either in the thermistor or current transformer (CT) system.

Relating to Thermistor Malfunction

1. Outdoor heat exchanger thermistor
2. Discharge pipe thermistor
3. Fin thermistor
4. Outside air thermistor

3.12.2 Detection of Overload and Overcurrent

Outline	In order to protect the inverter, detect an excessive output current, and for protecting compressor, monitor the OL operation.
Detail	<ul style="list-style-type: none"> ◆ If the OL (compressor head) temperature exceeds 266°F(130°C, depending on the model), the compressor is interrupted. ◆ If the inverter current exceeds 30A, the compressor is interrupted.

3.12.3 Insufficient Gas Control

Outline	<p>There are 2 ways of control to detect insufficient gas.</p> <p>I Detecting by DC current</p> <p>If the DC current is below the specified value and the frequency is higher than 40 Hz, it is regarded as insufficient gas.</p> <p>The DC current is weak compared to the normal operation when gas is insufficient, and gas insufficiency is detected by checking the DC current.</p>
----------------	---

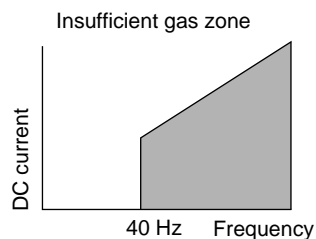

(R9315)

II Detecting by discharge pipe temperature

If the discharge temperature is higher than the target discharge pipe temperature, and the electronic expansion valve is fully open more than the specified time, it is regarded as insufficient gas.

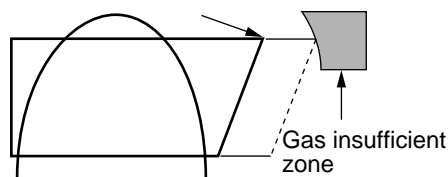

(R1391)



Refer to **Insufficient Gas** on page 102 for details.

3.13 Forced Operation Mode

Outline Forced operating mode includes only forced cooling.

Detail

Forced Cooling

Item	Forced Cooling
Forced operation allowing conditions	1) The outdoor unit is not abnormal and not in the 3-minute standby mode.
	2) The operating mode of the outdoor unit is the stop mode.
	3) The forced operation is ON. The forced operation is allowed when the above "and" conditions are met.
Starting/adjustment	If the forced operation switch is pressed when the above conditions are met.
1) Command frequency	55Hz
2) Electronic expansion valve opening	It depends on the capacity of the operating indoor unit.
3) Outdoor unit adjustment	Compressor is in operation
4) Indoor unit adjustment	The command of forced operation is transmitted to the indoor unit.
End	1) When the forced operation switch is pressed again.
	2) The operation is to end automatically after 15 min.
Others	The protect functions are prior to all others in the forced operation.

3.14 Additional Functions

3.14.1 POWERFUL Operation Mode

Compressor operating frequency is increased to PI Max. (Maximum Hz of operating room) and outdoor unit airflow rate is increased.

3.14.2 Voltage Detection Function

Power supply voltage is detected each time equipment operation starts.

3.15 Facility Setting Switch (cooling at low outdoor temperature)

Outline

This function is limited to facilities where the air conditioning is for cooling equipment, such as a computer room. Never use it in occupied spaces such as residences or offices.

Detail

You can expand the operation range to 0°F(−17.8°C) by turning on switch B (SW4) on the PCB. If the outdoor temperature falls to −4°F(−20°C) or lower, the operation will stop. If the outdoor temperature rises, the operation will start again.

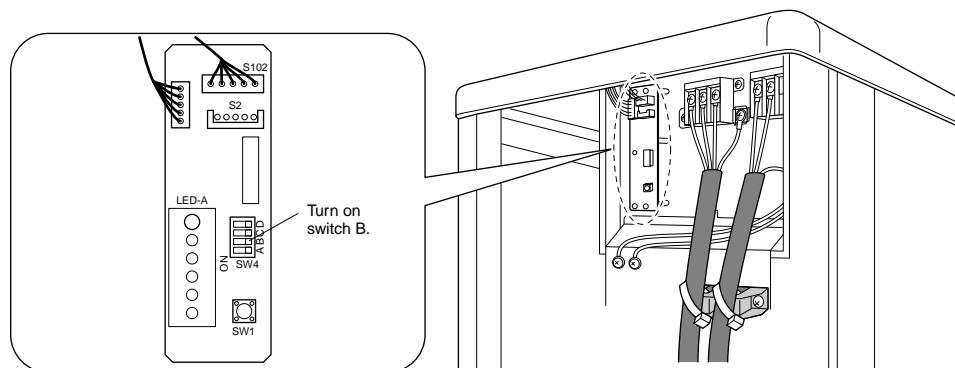

(R9672)



Caution

1. If the outdoor unit is installed where the heat exchanger of the unit is exposed to direct wind, provide a windbreak wall.
2. Intermittent noises may be produced by the indoor unit due to the outdoor fan turning on and off when using facility settings.
3. Do not place humidifiers or other items that might raise the humidity in rooms where facility settings are being used.
A humidifier might cause excess moisture to drip from the indoor unit outlet vent.
4. Use the indoor unit at the highest level of airflow rate.

Part 5

Operation Manual

1. System Configuration	45
2. Instruction.....	46
2.1 Remote Controller	46
2.2 AUTO · DRY · COOL · HEAT · FAN Operation	48
2.3 Adjusting the Airflow Direction.....	50
2.4 COMFORT AIRFLOW Operation	52
2.5 INTELLIGENT EYE Operation	53
2.6 POWERFUL Operation	55
2.7 OUTDOOR UNIT QUIET Operation	56
2.8 ECONO Operation	57
2.9 TIMER Operation	58
2.10 WEEKLY TIMER Operation	60

1. System Configuration

After the installation and test operation of the room air conditioner have been completed, follow instructions in this section to properly operate the system.

Providing thorough instructions to the user can reduce requests for servicing by 80%. However, if the installation and operating functions of the AC system are not explained properly, the customer may blame either the room air conditioner or its installation work because of improper handling. The installation work and the handing over of the unit can only be considered complete when its handling has been explained to the user without using technical terms but imparting full knowledge of the equipment.

2. Instruction

2.1 Remote Controller

Name of Parts

Remote Controller: ARC452A6

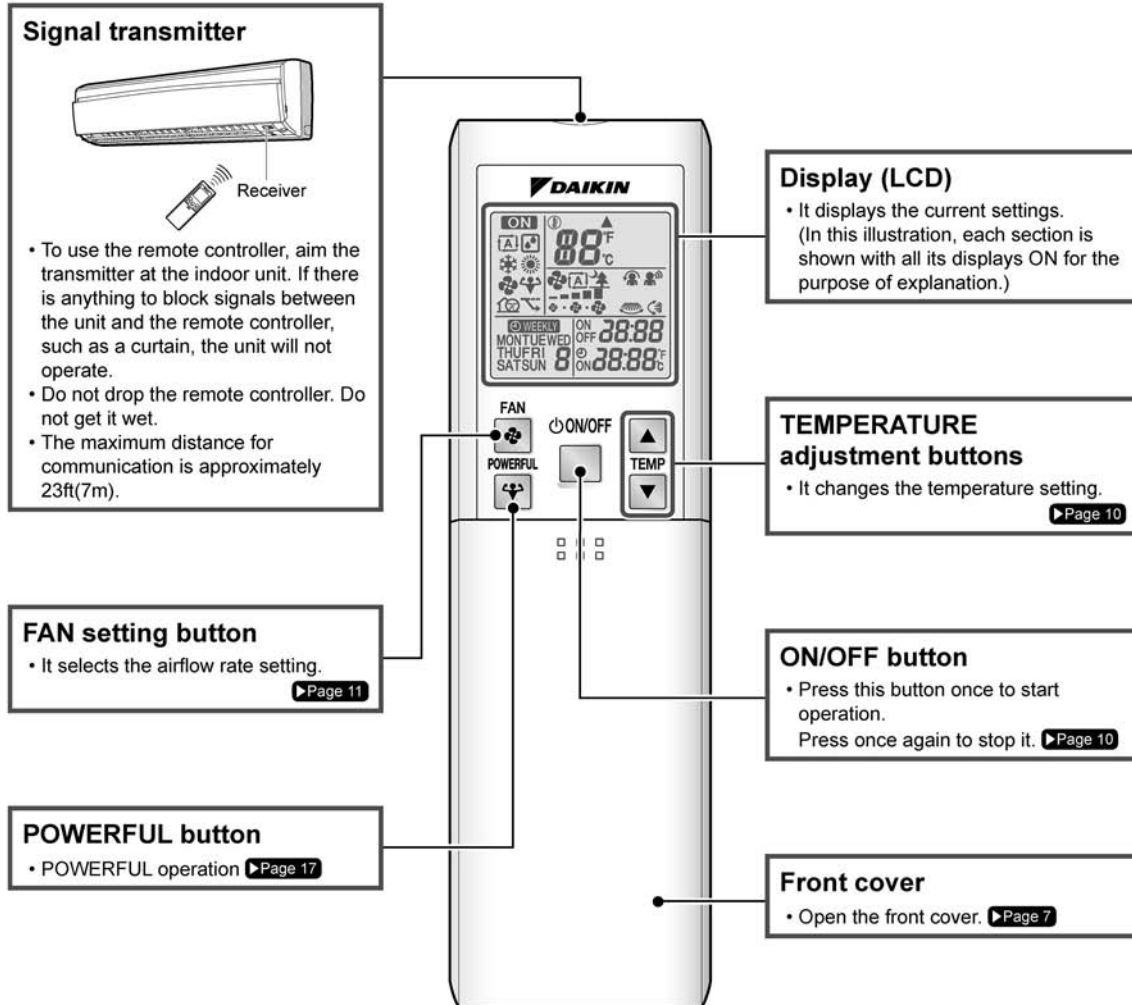

Open the front cover



MODE selector button
• It selects the operation mode.
(AUTO/DRY/COOL/HEAT/
FAN) ▶Page 10

ECONO button
• ECONO operation ▶Page 19

SWING button
• Adjusting the Airflow Direction
▶Page 12

QUIET button
• OUTDOOR UNIT QUIET
operation ▶Page 18

**COMFORT/SENSOR
button**
• COMFORT AIRFLOW and
INTELLIGENT EYE
operation ▶Page 14,15,16

OFF TIMER button
▶Page 20

WEEKLY : WEEKLY button
PROGRAM : PROGRAM button
COPY : COPY button
BACK : BACK button
NEXT : NEXT button
• WEEKLY TIMER operation
▶Page 22

**TIMER CANCEL
button**
• It cancels the timer setting.
▶Page 20,21
• It cannot be used for the
WEEKLY TIMER operation.

ON TIMER button
▶Page 21

SELECT button
• It changes the ON/OFF
TIMER and WEEKLY TIMER
settings. ▶Page 20,21,23

CLOCK button

2.2 AUTO · DRY · COOL · HEAT · FAN Operation

AUTO · DRY · COOL · HEAT · FAN Operation

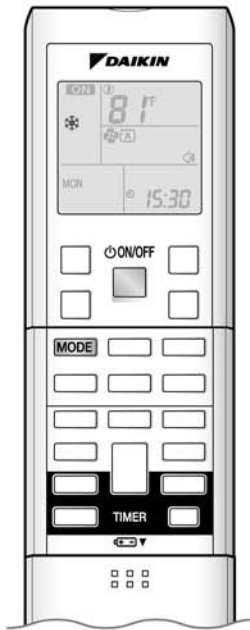

The air conditioner operates with the operation mode of your choice.
From the next time on, the air conditioner will operate with the same operation mode.

■ To start operation

1. Press **MODE** and select a operation mode.

- Each pressing of the button advances the mode setting in sequence.

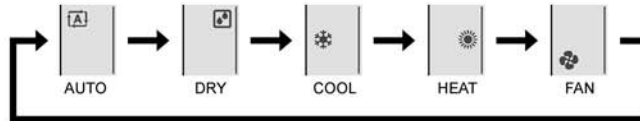

2. Press .

- “ON” is displayed on the LCD.
- The OPERATION lamp lights up.

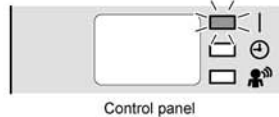

■ To stop operation

Press  again.

- “ON” is displayed on the LCD.
- Then OPERATION lamp goes off.

■ To change the temperature setting

Press  or  .

- The displayed items on the LCD will change whenever either one of the buttons is pressed.

DRY or FAN mode	COOL mode	HEAT mode	AUTO mode
The temperature setting is not variable.	64 – 90°F (18 – 32°C)	50 – 86°F (10 – 30°C)	64 – 86°F (18 – 30°C)
	Press ▲ to raise the temperature and press ▼ to lower the temperature.		

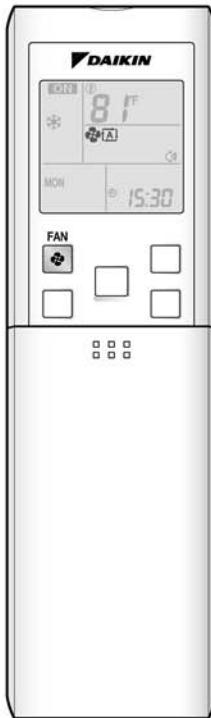

■ To change the airflow rate setting

Press .

DRY mode	AUTO or COOL or HEAT or FAN mode
The airflow rate setting is not variable.	Five levels of airflow rate setting from "☺" to "☺" plus "[A]" and "☺" are available. 

- Indoor unit quiet operation
When the airflow is set to "☺", the noise from the indoor unit will become quieter. Use this when making the noise quieter. The unit might lose capacity when the airflow rate is set to a weak level.
- Each pressing of the button advances the airflow rate setting in sequence.



NOTE

■ Note on HEAT operation

- Since this air conditioner heats the room by taking heat from outdoor air to indoors, the heating capacity becomes smaller in lower outdoor temperatures. If the heating effect is insufficient, it is recommended to use another heating appliance in combination with the air conditioner.
- The heat pump system heats the room by circulating hot air around all parts of the room. After the start of heating operation, it takes some time before the room gets warmer.
- In heating operation, frost may occur on the outdoor unit and lower the heating capacity. In that case, the system switches into defrosting operation to take away the frost.
- During defrosting operation, hot air does not flow out of indoor unit.

■ Note on COOL operation

- This air conditioner cools the room by blowing the hot air in the room outside, so if the outside temperature is high, the performance of the air conditioner drops.

■ Note on DRY operation

- The computer chip works to rid the room of humidity while maintaining the temperature as much as possible. It automatically controls temperature and airflow rate, so manual adjustment of these functions is unavailable.

■ Note on AUTO operation

- In AUTO operation, the system selects a temperature setting and an appropriate operation mode (COOL or HEAT) based on the room temperature at the start of the operation.
- The system automatically reselects setting at a regular interval to bring the room temperature to user-setting level.
- If you do not like AUTO operation, manually change the set temperature.

■ Note on FAN operation

- This mode is valid for fan only.

■ Note on airflow rate setting

- At smaller airflow rates, the cooling (heating) effect is also smaller.

2.3 Adjusting the Airflow Direction

Adjusting the Airflow Direction

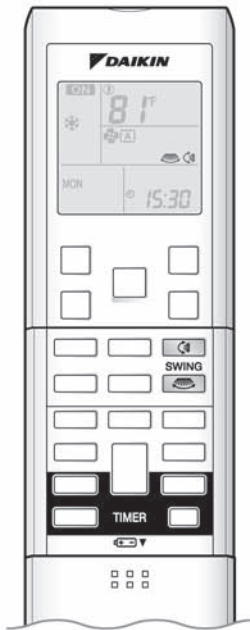

You can adjust the airflow direction to increase your comfort.

Adjusting the upper and lower airflow direction

■ To adjust the louvers (horizontal blades):

1. Press .

- “” is displayed on the LCD and the louvers will begin to swing.

2. When the louvers have reached the desired position, press  once more.

- The louvers will stop moving.
- “” is no longer displayed on the LCD.

Adjusting the right and left airflow direction

■ To adjust the fins (vertical blades):

3. Press .





- “” is displayed on the LCD.

4. When the fins have reached the desired position, press the  once more.

- The fins will stop moving.
- “” is no longer displayed on the LCD.

Adjusting the 3-D airflow direction

■ To start 3-D Airflow

1. 3. Press the  and the  :
the “” and “” display will light up and the fins and louvers will move in turn.

■ To cancel 3-D Airflow

2. 4. Press either the  or the .

■ COMFORT AIRFLOW operation

- Check COMFORT AIRFLOW operation in the section of “COMFORT AIRFLOW Operation” and “INTELLIGENT EYE Operation”. [▶Page 14,15](#)

NOTE

■ Notes on fins and louvers angles

- When “SWING button” is selected, the fins swinging range depends on the operation mode. (See the figure.)

Three-Dimensional (3-D) Airflow

- Using three-dimensional airflow circulates cold air, which tends to collect at the bottom of the room, and hot air, which tends to collect near the ceiling, throughout the room, preventing areas of cold and hot developing.

■ ATTENTION

- Always use a remote controller to adjust the angles of the fins and louvers. If you attempt to move it forcibly with hand when it is swinging, the mechanism may be broken.
- Always use a remote controller to adjust the louvers angles. Inside the air outlet, a fan is rotating at a high speed.

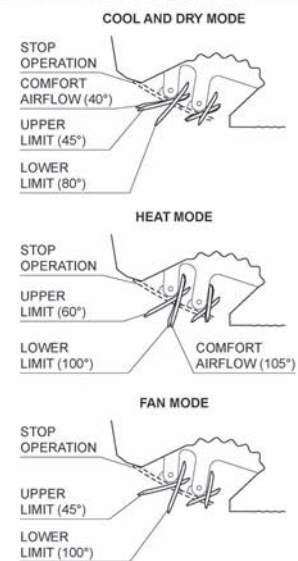

2.4 COMFORT AIRFLOW Operation

COMFORT AIRFLOW Operation

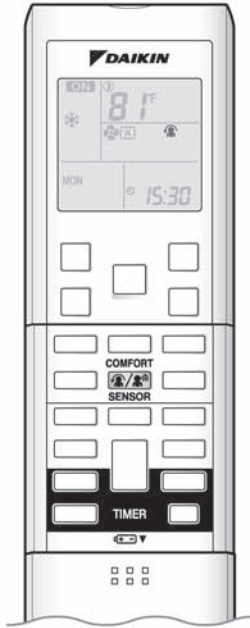

The flow of air will be in the upward direction while in cooling mode and in the downward direction while in heating mode, which provides a comfortable airflow that will not come in direct contact with people.

■ To start COMFORT AIRFLOW operation

1. Press  and select “” on the LCD.

- Each time the  is pressed a different setting option is displayed on the LCD.
- By selecting “•” from the following icons, the air conditioner will be in COMFORT AIRFLOW operation combined with INTELLIGENT EYE operation. [▶Page 16](#)



■ To cancel COMFORT AIRFLOW operation

2. Press .

- Press the button to select “Blank”.

NOTE

■ Notes on “COMFORT AIRFLOW Operation”

- The fin position will change, preventing air from blowing directly on the occupants of the room.
- POWERFUL operation and COMFORT AIRFLOW operation cannot be used at the same time.
- The volume of air will be set to AUTO. If the upward and downward airflow direction is selected, the COMFORT AIRFLOW function will be canceled.
- Priority is given to the function of whichever button is pressed last.
- The COMFORT AIRFLOW function makes the following airflow direction adjustments.
The fin will move upward while cooling so that the airflow will be directed upward.
The fin will move downward while heating so that the airflow will be directed downward.

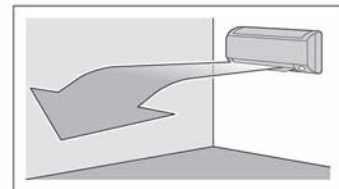

Cooling operation

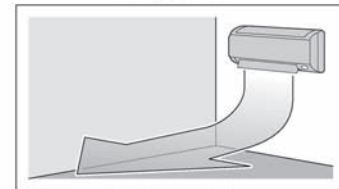

Heating operation

2.5 INTELLIGENT EYE Operation

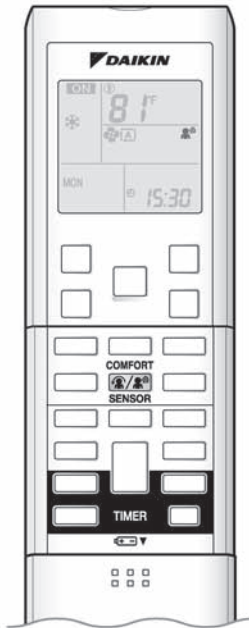

INTELLIGENT EYE Operation



“INTELLIGENT EYE” is the infrared sensor which detects the human movement.

■ To start INTELLIGENT EYE operation

1. Press and select “” on the LCD.

- Each time the  is pressed a different setting option is displayed on the LCD.
- By selecting “” from the following icons, the air conditioner will be in INTELLIGENT EYE operation combined with COMFORT AIRFLOW operation. [▶Page 16](#)



- When the fins (horizontal blades) are swinging, the operating as above will stop movement of them.

■ To cancel the INTELLIGENT EYE operation

2. Press .

- Press the button to select “Blank”.

[EX.]

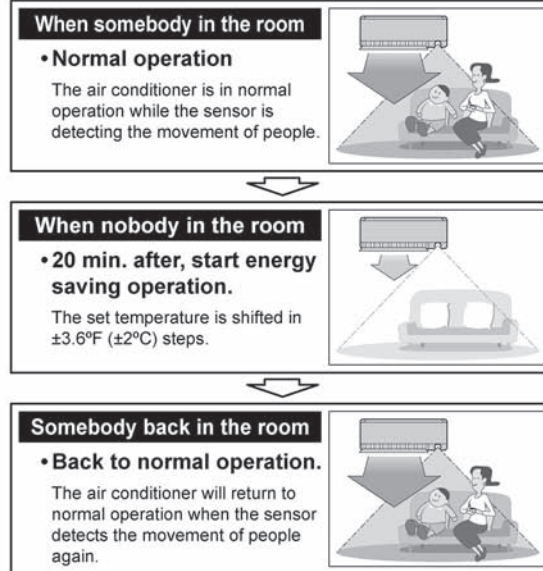

INTELLIGENT EYE Operation

“INTELLIGENT EYE” is useful for Energy Saving

■ Energy saving operation

- Change the temperature $-3.6^{\circ}\text{F}(-2^{\circ}\text{C})$ in heating / $+3.6^{\circ}\text{F}(+2^{\circ}\text{C})$ in cooling / $+3.6^{\circ}\text{F}(+2^{\circ}\text{C})$ in dry mode from set temperature.
- Decrease the airflow rate slightly in FAN mode only.
- If no presence detected in the room for 20 minutes.

NOTE

■ Notes on “INTELLIGENT EYE”

- Application range is as follows.

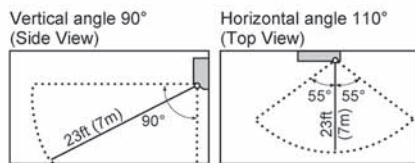

- Sensor may not detect moving objects further than 23ft(7m) away. (Check the application range)
- Sensor detection sensitivity changes according to indoor unit location, the speed of passersby, temperature range, etc.
- The sensor also mistakenly detects pets, sunlight, fluttering curtains and light reflected off of mirrors.
- INTELLIGENT EYE operation will not go on during powerful operation.
- NIGHT SET MODE [▶Page 20](#) will not go on during use of INTELLIGENT EYE operation.

■ To combine “COMFORT AIRFLOW Operation” and “INTELLIGENT EYE Operation”

1. Press and select “” on the LCD.

- Each time the  is pressed a different setting option is displayed on the LCD.



2. Press .

- Press the button to select “Blank”.

- The air conditioner can go into operation with the COMFORT AIRFLOW and INTELLIGENT EYE functions combined.
- The volume of air will be set to AUTO. If the upward and downward airflow direction is selected, the COMFORT AIRFLOW operation will be canceled.
- Priority is given to the function of whichever button is pressed last.

CAUTION

- Do not place large objects near the sensor.
Also keep heating units or humidifiers outside the sensor’s detection area. This sensor can detect undesirable objects.
- Do not hit or violently push the INTELLIGENT EYE sensor. This can lead to damage and malfunction.

2.6 POWERFUL Operation

POWERFUL Operation

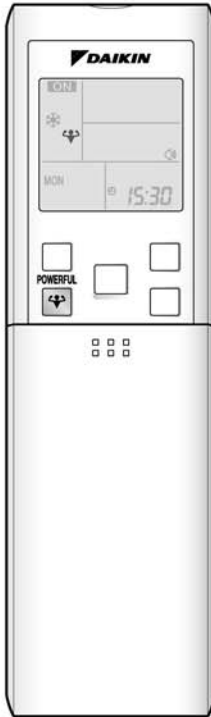

POWERFUL operation quickly maximizes the cooling (heating) effect in any operation mode. You can get the maximum capacity.

■ To start POWERFUL operation

Press  during operation.

- POWERFUL operation ends in 20 minutes. Then the system automatically operates again with the previous settings which were used before POWERFUL operation.
- “” is displayed on the LCD.
- When using POWERFUL operation, there are some functions which are not available.

■ To cancel POWERFUL operation

Press  again.

- “” disappears from the LCD.

NOTE

■ Notes on POWERFUL operation

- POWERFUL Operation cannot be used together with ECONO, COMFORT AIRFLOW or QUIET Operation. Priority is given to the function of whichever button is pressed last.
- POWERFUL Operation can only be set when the unit is running. Pressing the operation stop button causes the settings to be canceled, and the “” disappears from the LCD.
- POWERFUL Operation will not increase the capacity of the air conditioner if the air conditioner is already in operation with its maximum capacity demonstrated.
- **In COOL and HEAT mode**
To maximize the cooling (heating) effect, the capacity of outdoor unit must be increased and the airflow rate be fixed to the maximum setting. The temperature and airflow settings are not variable.
- **In DRY mode**
The temperature setting is lowered by 4.5°F (2.5°C) and the airflow rate is slightly increased.
- **In FAN mode**
The airflow rate is fixed to the maximum setting.
- **In AUTO mode**
To maximize the cooling (heating) effect, the capacity of outdoor unit must be increased and the airflow rate be fixed to the maximum setting.

2.7 OUTDOOR UNIT QUIET Operation

OUTDOOR UNIT QUIET Operation

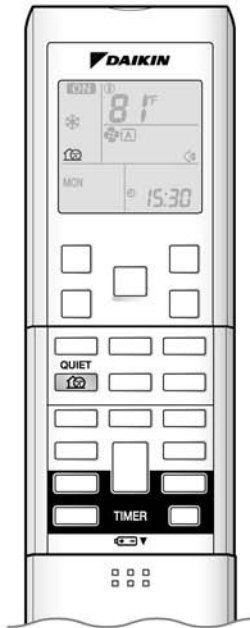

OUTDOOR UNIT QUIET operation lowers the noise level of the outdoor unit by changing the frequency and fan speed on the outdoor unit. This function is convenient during night.

■ To start OUTDOOR UNIT QUIET operation

Press .

- "🔇" is displayed on the LCD.

■ To cancel OUTDOOR UNIT QUIET operation

Press  again.

- "🔇" disappears from the LCD.

NOTE

■ Note on OUTDOOR UNIT QUIET operation

- This function is available in COOL, HEAT, and AUTO modes.
(This is not available in FAN and DRY mode.)
- POWERFUL operation and OUTDOOR UNIT QUIET operation cannot be used at the same time.
Priority is given to the function of whichever button is pressed last.
- If operation is stopped using the remote controller or the main unit ON/OFF switch when using OUTDOOR UNIT QUIET operation, "🔇" will remain on the remote controller display.
- OUTDOOR UNIT QUIET Operation will drop neither the frequency nor fan speed if the frequency and fan speed have been already dropped low enough.

2.8 ECONO Operation

ECONO Operation

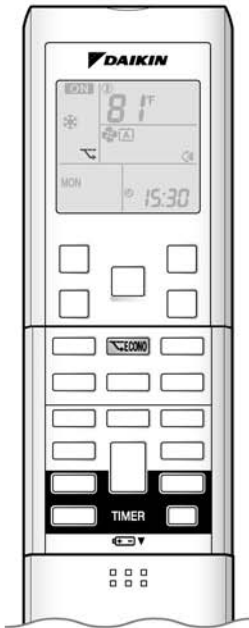

ECONO operation is a function which enables efficient operation by limiting the maximum power consumption value. This function is useful for cases in which attention should be paid to ensure a circuit breaker will not trip when the product runs alongside other appliances.

■ To start ECONO operation

Press  during operation.

- "ECONO" is displayed on the LCD.

■ To cancel ECONO operation

Press  again.

- "ECONO" disappears from the LCD.

Running current and power consumption

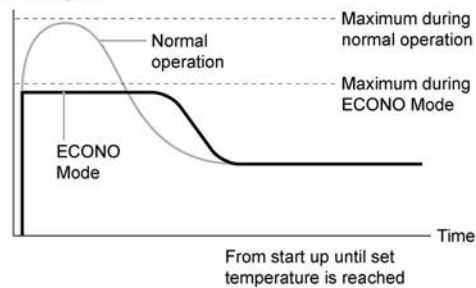

- This diagram is a representation for illustrative purposes only.
- * The maximum running current and power consumption of the air conditioner in ECONO mode vary with the connecting outdoor unit.

NOTE

- ECONO Operation can only be set when the unit is running. Pressing the operation stop button causes the settings to be canceled, and the "ECONO" disappears from the LCD.
- ECONO operation is a function which enables efficient operation by limiting the power consumption of the outdoor unit (operating frequency).
- ECONO operation functions in AUTO, COOL, DRY, and HEAT modes.
- POWERFUL and ECONO operation cannot be used at the same time. Priority is given to the function of whichever button is pressed last.
- Power consumption may not drop even if ECONO operation is used if the level of power consumption is already low.

2.9 TIMER Operation

TIMER Operation

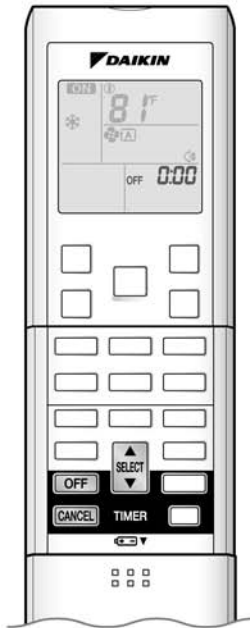

Timer functions are useful for automatically switching the air conditioner on or off at night or in the morning. You can also use OFF TIMER and ON TIMER in combination.

■ To use OFF TIMER operation

- Check that the clock is correct.
If not, set the clock to the present time. ▶Page 9

1. Press **OFF**.



- "OFF" and "0:00" is displayed.
• "OFF" blinks.

- "⌚" and day of the week disappears from LCD.

2. Press **SELECT** until the time setting reaches the point you like.

- Every pressing of either button increases or decreases the time setting by 10 minutes. Holding down either button changes the setting rapidly.

3. Press **OFF** again.

- "OFF" and setting time are displayed on the LCD.
- The TIMER lamp lights up.



Control panel

■ To cancel OFF TIMER Operation

Press **CANCEL**.

- "OFF" and setting time disappears from LCD.
- "⌚" and day of the week are displayed on the LCD.
- The TIMER lamp goes off.

NOTE

- When TIMER is set, the present time is not displayed.
- Once you set ON, OFF TIMER, the time setting is kept in the memory. (The memory is canceled when remote controller batteries are replaced.)
- When operating the unit via the ON/OFF Timer, the actual length of operation may vary from the time entered by the user. (Maximum approx. 10 minutes)

■ NIGHT SET MODE

When the OFF TIMER is set, the air conditioner automatically adjusts the temperature setting (0.9°F(0.5°C) up in COOL, 3.6°F(2.0°C) down in HEAT) to prevent excessive cooling (heating) for your pleasant sleep.

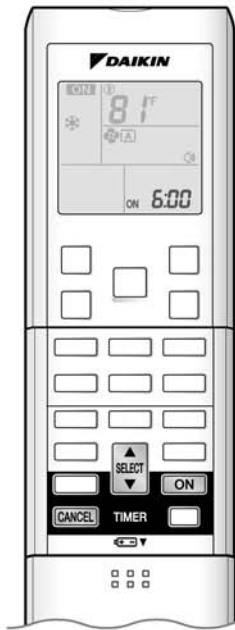

■ To use ON TIMER operation

- Check that the clock is correct.
If not, set the clock to the present time. ▶Page 9

1. Press **ON**.

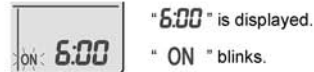

- "⌚" and day of the week disappears from LCD.

2. Press **SELECT** until the time setting reaches the point you like.

- Every pressing of either button increases or decreases the time setting by 10 minutes. Holding down either button changes the setting rapidly.

3. Press **ON** again.

- "ON" and setting time are displayed on the LCD.
- The TIMER lamp lights up.



■ To cancel OFF TIMER Operation

Press **CANCEL**.

- "ON" and setting time disappears from LCD.
- "⌚" and day of the week are displayed on the LCD.
- The TIMER lamp goes off.

■ To combine ON TIMER and OFF TIMER

- A sample setting for combining the 2 timers is shown below.

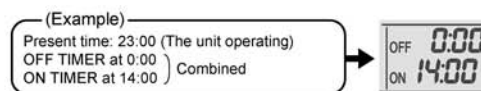

ATTENTION

- In the following cases, set the timer again.
 - After a breaker has turned OFF.
 - After a power failure.
 - After replacing batteries in the remote controller.

2.10 WEEKLY TIMER Operation

WEEKLY TIMER Operation

Up to 4 timer settings can be saved for each day of the week. It is convenient if the WEEKLY TIMER is set according to the family's life style.

■ Examples of using the WEEKLY TIMER settings:

Example: The same timer settings are made for the week from Monday through Friday while different timer settings are made for the weekend.

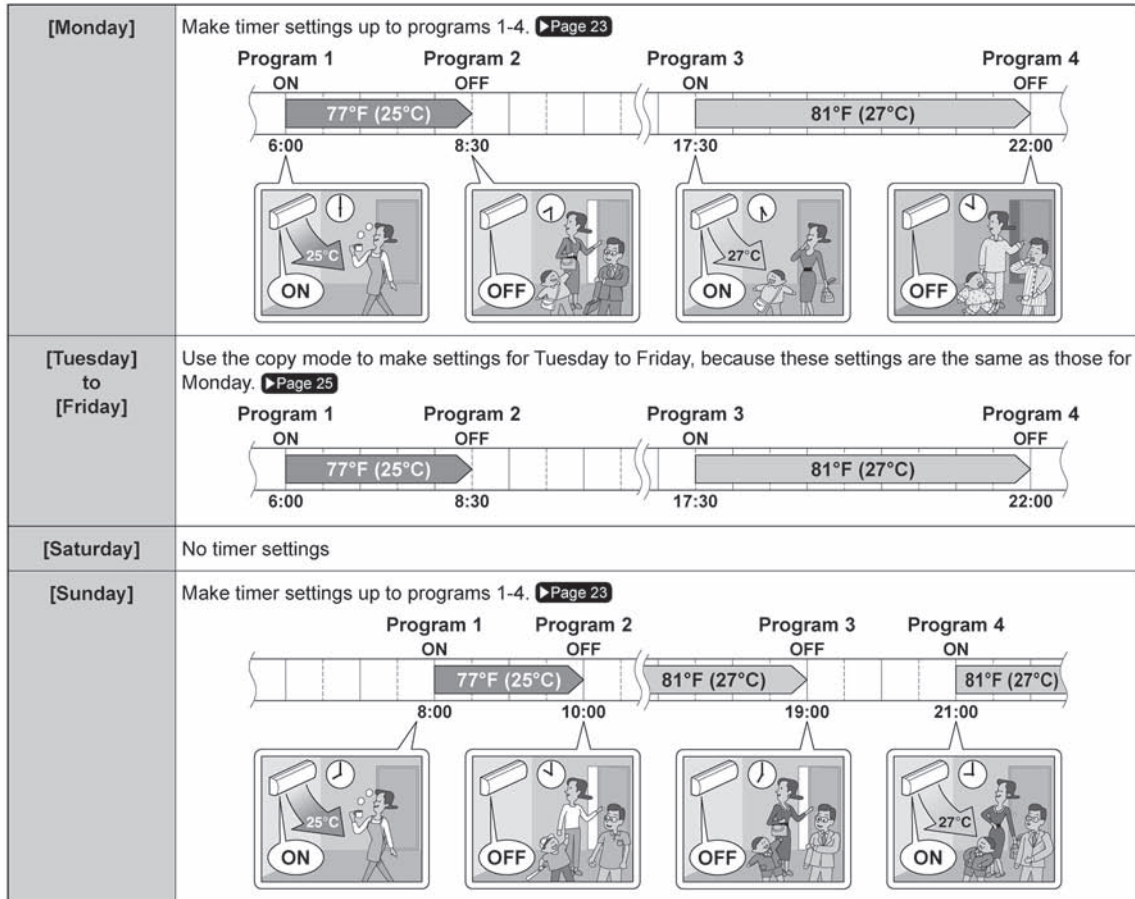

- Up to 4 settings per day and 28 settings per week can be made with the WEEKLY TIMER. The effective use of the copy mode ensures the ease of making settings.
- The use of ON-ON-ON-ON settings, for example, makes it possible to schedule operating mode and set temperature changes. Furthermore, by using OFF-OFF-OFF-OFF settings, only the turn-OFF time of each day can be set. This will turn OFF the air conditioner automatically if the user forgets to turn it OFF.

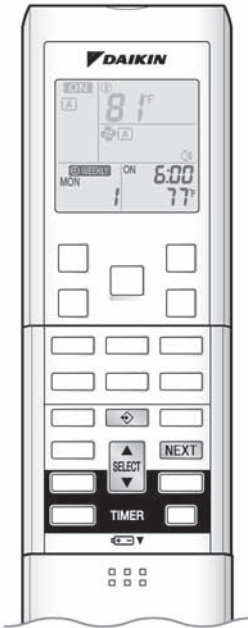

■ To use WEEKLY TIMER operation

- Make sure the day of the week and time are set. If not, set the day of the week and time.

▶Page 9

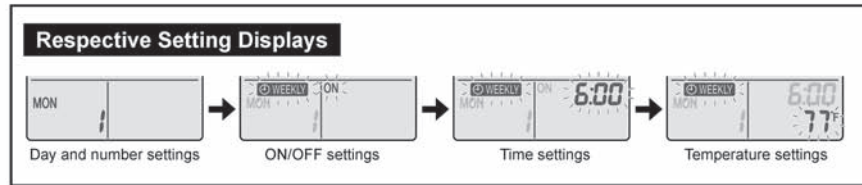
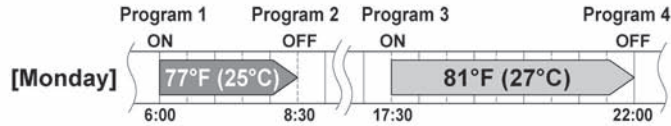

1. Press .

- The day of the week and the setting number is displayed.
- 1 to 4 settings can be made per day.

2. Press to select the desired day of the week and the setting number.

- Pressing  changes the setting number and the day of the week.

3. Press .

- The day of the week will be set.
- "WEEKLY" and "ON" blink.

4. Press to select the desired mode.

- "WEEKLY" and "ON" or "OFF" will flash.



- Go to STEP 9 if "no setting" is selected.

5. Press .

- The weekly mode will be set.
- "WEEKLY" and "6:00" blink.

WEEKLY TIMER Operation

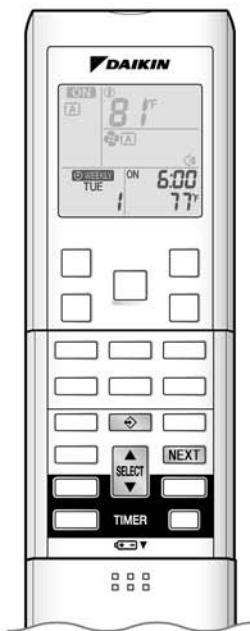

6. Press to select the desired time.

- The time can be set between 0:00 and 23:50 in 10 minute intervals.
- Press **BACK** to return to the mode setting.
- Go to **STEP 9** if "OFF" is selected at **STEP 4**.

7. Press .

- The time will be set.
- "Ⓢ WEEKLY" and the temperature blink.

8. Press to select the desired temperature.

- The temperature can be set between 50°F (10°C) and 90°F (32°C).
Cooling: The unit operates at 65°F (18°C) even if it is set at 50 (10) to 63°F (17°C).
Heating: The unit operates at 86°F (30°C) even if it is set at 88 (31) to 90°F (32°C).
- To return to the time setting, press **BACK**.
- The set temperature is only displayed when the mode setting is on.

9. Press .

- The temperature will be set and go to the next reservation setting.
- To continue further settings, repeat the procedure from **STEP 2**.

10. Press to complete the setting.



- Point the remote controller toward the air conditioner and press the buttons to operate. The air conditioner will beep and the operation lamp will flash.
- "Ⓢ WEEKLY" is displayed on the LCD.
- The **TIMER** lamp lights up.



Control panel

NOTE

■ WEEKLY TIMER

- Do not forget to set the clock on the remote controller first. ▶ [Page 9](#)
- The day of the week, ON/OFF time can be set with WEEKLY TIMER. For ON-TIMER, settings other than the above are based on the remote controller settings just before the operation.
- Both WEEKLY TIMER and ON/OFF timer cannot be used at the same time. The ON/OFF timer has priority if it is set while WEEKLY TIMER is still active. WEEKLY TIMER is activated after the reserved ON/OFF timer is completed.
- The **WEEKLY** activates or deactivates the reservation.
- To set WEEKLY TIMER, press  and make a reservation according to the procedures.
- Only the time and set temperature set with the weekly timer are sent with the .
- Set the weekly timer only after setting the operation mode, the fan strength, and the fan direction ahead of time.
- Up to 4 settings per day and up to 28 settings per week can be reserved with WEEKLY TIMER. If a reservation deactivated with **WEEKLY** is activated once again, the last reservation mode will be used.
- Shutting the breaker off, power failure, and other similar events will render operation of the indoor unit's internal clock inaccurate. Reset the clock. ▶ [Page 9](#)
- The **BACK** can be used only for the mode, time and temperature settings.
It cannot be used to go back to the reservation number.

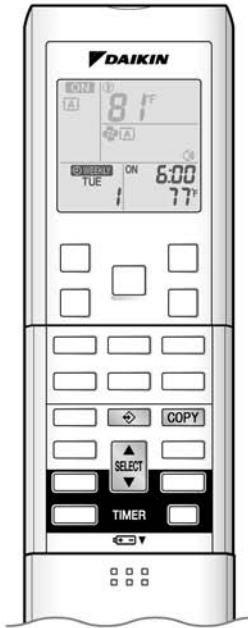

■ Using copy mode

- A reservation made once can be easily copied and the same settings used for another day of the week.

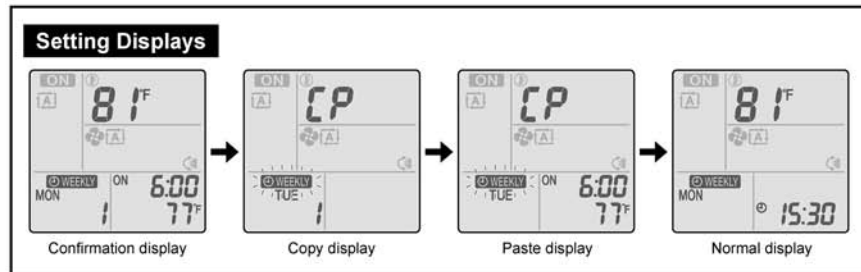
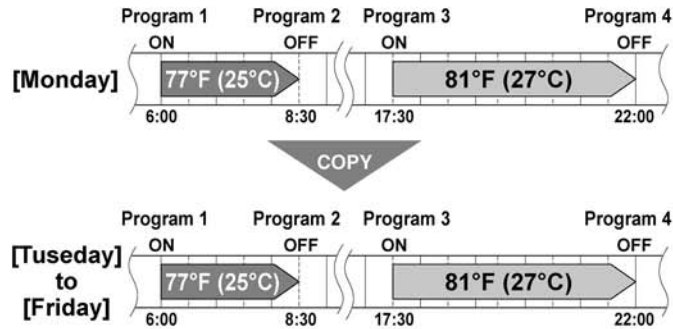

1. Press .

2. Press to confirm the day of the week to be copied.

3. Press .

- This activates copy mode.
- Copy whole reservation of the selected day of the week.

4. Press to select the destination day of the week.

5. Press .

- The reservation will be copied to the selected day of the week. The whole reservation of the selected day of the week will be copied.
- To continue copying the settings to other days of the week, repeat STEP 4 and STEP 5.

6. Press .

- Exit copy mode.

WEEKLY TIMER Operation

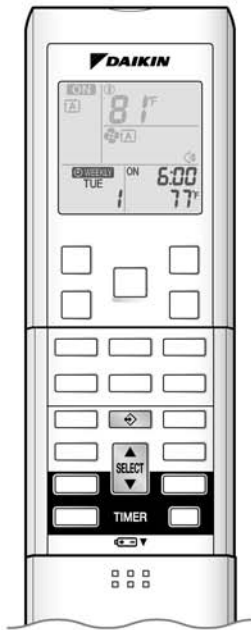

■ Confirming a reservation

- The reservation can be confirmed.

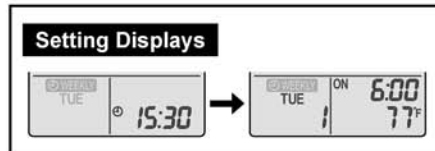

1. Press  .

- The day of the week and the reservation number of the current day will be displayed.

2. Press  **to select the day of the week and the reservation number to be confirmed.**

- Pressing  displays the reservation details.

3. Press  .

- Reservation confirmation complete.
- "WEEKLY" is displayed on the LCD.
- The TIMER lamp lights up.



Control panel

NOTE

■ COPY MODE

- The entire reservation of the source day of the week is copied in the copy mode. Detailed settings can be made after the copy is completed.

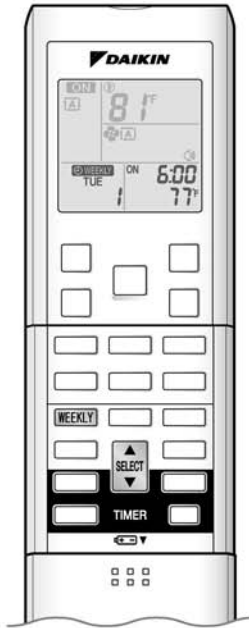

■ To cancel WEEKLY TIMER operation

Press **WEEKLY** to deactivate the WEEKLY operation.

- The "WEEKLY" will disappear from the display.
- The TIMER lamp goes off.
- To reactivate the WEEKLY TIMER operation, press the **WEEKLY** again.

■ Canceling individual reservations

- This function can be used for canceling reservations for each day of the week.
- It can be used while confirming or setting reservations.

1. Select the day of the week to be canceled with the



2. Hold the **WEEKLY** for 5 seconds.

- The selected reservation will be canceled.

■ Canceling all reservations

Hold the **WEEKLY** for 5 seconds.

- Be sure to direct the remote control toward the main unit and check for a receiving tone.
- This operation is not effective while WEEKLY TIMER is being set.
- All reservations will be canceled.

Part 6

Service Diagnosis

1. Caution for Diagnosis	67
2. Problem Symptoms and Measures	68
3. Service Check Function	69
4. Troubleshooting	72
4.1 Error Codes and Description	72
4.2 Indoor Unit PCB Abnormality	73
4.3 Freeze-up Protection Control or High Pressure Control.....	74
4.4 Fan Motor (DC Motor) or Related Abnormality.....	76
4.5 Thermistor or Related Abnormality (Indoor Unit).....	78
4.6 Signal Transmission Error (between Indoor and Outdoor Unit)	79
4.7 Unspecified Voltage (between Indoor and Outdoor Units)	80
4.8 Outdoor Unit PCB Abnormality.....	81
4.9 OL Activation (Compressor Overload)	82
4.10 Compressor Lock	83
4.11 DC Fan Lock	84
4.12 Input Overcurrent Detection	85
4.13 Four-Way Valve Abnormality.....	86
4.14 Discharge Pipe Temperature Control.....	88
4.15 High Pressure Control in Cooling	89
4.16 Compressor System Sensor Abnormality	90
4.17 Position Sensor Abnormality	91
4.18 CT or Related Abnormality	93
4.19 Thermistor or Related Abnormality (Outdoor Unit).....	95
4.20 Electrical Box Temperature Rise.....	97
4.21 Radiation Fin Temperature Rise	98
4.22 Output Overcurrent Detection	100
4.23 Insufficient Gas.....	102
4.24 Low-voltage Detection or Over-voltage Detection.....	104
4.25 Signal Transmission Error on Outdoor Unit PCB	105
5. Check	106
5.1 How to Check.....	106

1. Caution for Diagnosis

The operation lamp flashes when any of the following errors are detected.

1. When a protection device of the indoor or outdoor unit is activated or when the thermistor malfunctions, disabling equipment operation.
 2. When a signal transmission error occurs between the indoor and outdoor units.
- In either case, conduct the diagnostic procedure described in the following pages.

Location of Operation Lamp

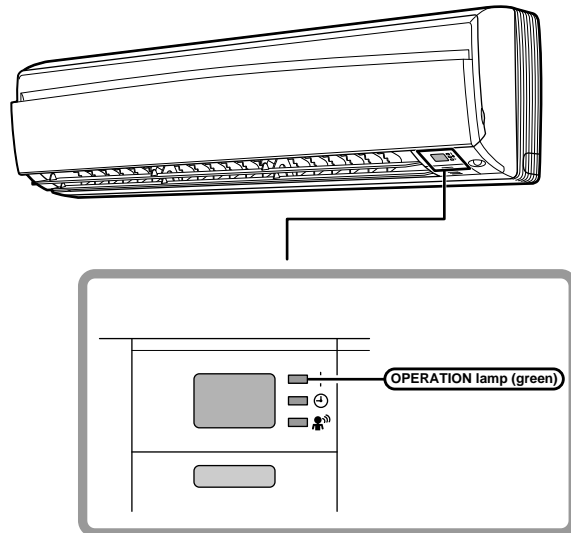

(R9315)

Troubleshooting with the LED Indication

The outdoor unit has one green LED (LED A) on the PCB. The flashing green LED indicates normal condition of microcomputer operation.

2. Problem Symptoms and Measures

Symptom	Check Item	Details of Measure	Reference Page
None of the units operates.	Check the power supply.	Check to make sure that the rated voltage is supplied.	—
	Check the type of the indoor units.	Check to make sure that the indoor unit type is compatible with the outdoor unit.	—
	Check the outdoor air temperature.	Heating operation cannot be used when the outdoor air temperature is 75.2°F(24°C) or higher (only for heat pump model), and cooling operation cannot be used when the outside temperature is below 10.4°F(-12°C).*	—
	Diagnosis with remote controller indication	—	72
	Check the remote controller addresses.	Check to make sure that address settings for the remote controller and indoor unit are correct.	—
Operation sometimes stops.	Check the power supply.	A power failure of 2 to 10 cycles can stop air conditioner operation. (Operation lamp OFF)	—
	Check the outdoor air temperature.	Heating operation cannot be used when the outdoor air temperature is 75.2°F(24°C) or higher (only for heat pump model), and cooling operation cannot be used when the outside temperature is below 10.4°F(-12°C).*	—
	Diagnosis with remote controller indication	—	72
Equipment operates but does not cool, or does not heat (only for heat pump model).	Check for wiring and piping errors in the indoor and outdoor units connection wires and pipes.	Conduct the wiring/piping error check described on the product diagnosis nameplate.	—
	Check for thermistor detection errors.	Check to make sure that the main unit's thermistor has not dismantled from the pipe holder.	—
	Check for faulty operation of the electronic expansion valve.	Set the units to cooling operation, and compare the temperatures of the liquid side connection pipes of the connection section among rooms to check the opening and closing operation of the electronic expansion valves of the individual units.	—
	Diagnosis with remote controller indication	—	72
	Diagnosis by service port pressure and operating current	Check for insufficient gas.	110
Large operating noise and vibrations	Check the output voltage of the power transistor.	—	111
	Check the power transistor.	—	—
	Check the installation condition.	Check to make sure that the required spaces for installation (specified in the Engineering Data Book, etc.) are provided.	—

* 0°F(-17.8°C) with low ambient setting: see Page 42.

3. Service Check Function

Check Method 1

1. When the timer cancel button is held down for 5 seconds, a "00" indication flashes on the temperature display section.

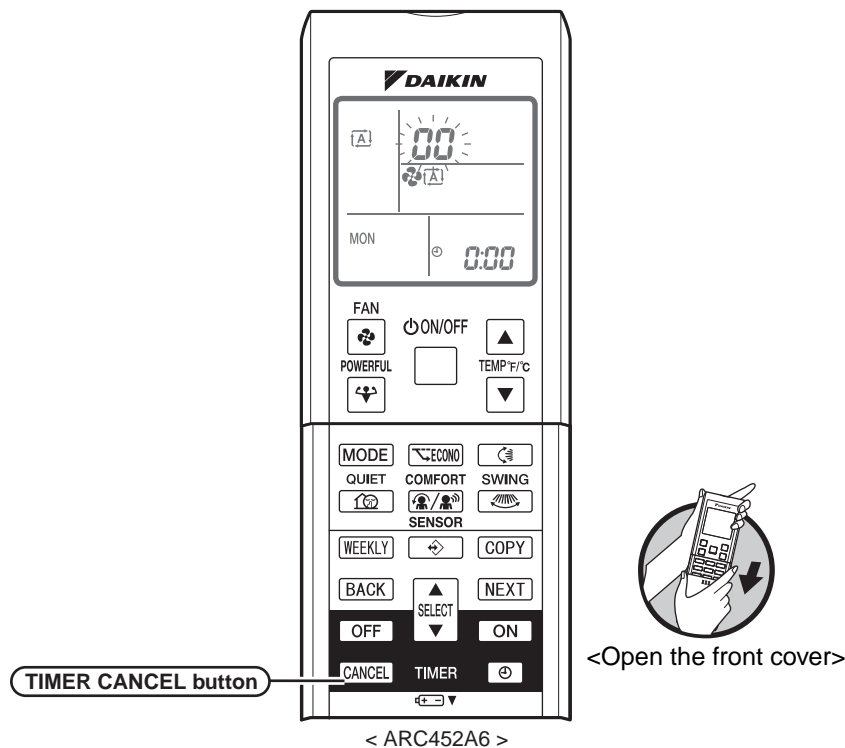

2. Press the timer cancel button repeatedly until a continuous beep is produced.
 - The code indication changes in the sequence shown below, and notifies with a long beep.

No.	Code	No.	Code	No.	Code
1	00	13	07	25	UR
2	04	14	R3	26	UH
3	15	15	H8	27	P4
4	E6	16	H9	28	L3
5	H6	17	09	29	L4
6	H0	18	04	30	H7
7	R6	19	05	31	U2
8	E7	20	J3	32	ER
9	U0	21	J6	33	RH
10	F3	22	E5	34	FR
11	R5	23	R1	35	H1
12	F6	24	E1	36	P9



Note:

1. A short beep and two consecutive beeps indicate non-corresponding codes.
2. To cancel the code display, hold the timer cancel button down for 5 seconds. The code display also cancels itself if the button is not pressed for 1 minute.

Check Method 2

1. Press the 3 buttons (TEMP▲, TEMP▼, MODE) simultaneously to enter the diagnosis mode.

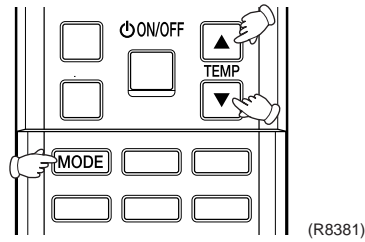

The left-side numeral blinks.

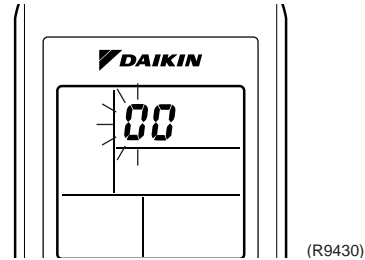

2. Press TEMP▲ or ▼ button and change the figure until you hear the sound of “beep”.

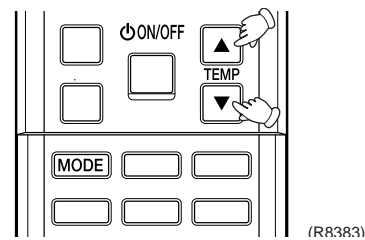

3. Diagnose by the sound.
 - ★beep: The left-side numeral is incorrect; move to the next number.
 - ★beep-beep: The right-side number is incorrect; move to the next number.
 - ★long beeeeeep: Both numbers are correct; this is your error code. Refer to the troubleshooting section to learn more about his code. (→See 7.)
4. Press the MODE button.

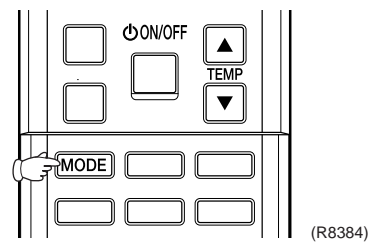

The right-side numeral blinks.

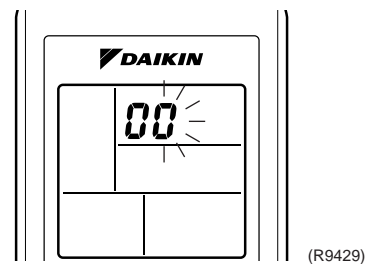

5. Press the TEMP button.
Press TEMP▲ or ▼ button and change the figure until you hear the long sound of “beep”.

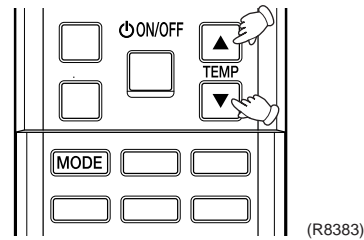

6. Diagnose by the sound.
 - ★beep : The left-side numeral is incorrect; move to the next number.
 - ★beep-beep: The left-side numeral is incorrect but the right-side numeral is correct. .
 - ★“beep” : Both the right & left numerals are the correct error codes designators.
7. Determine the error code.
The figure indicated when you hear the long “beep” sound is the error code.
(Error codes and description → Refer to page 72.)
8. Press the MODE button to exit from the diagnosis mode.

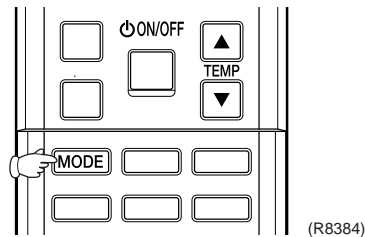

The display “7-” means the trial operation mode.
(Refer to page 183 for trial operation.)

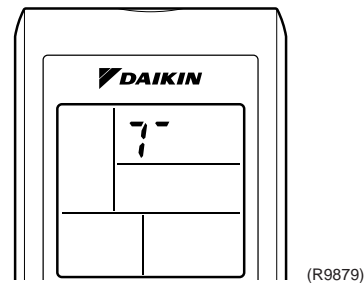

9. Press the ON/OFF button twice to return to the normal mode.

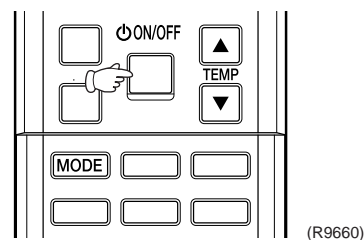

Note: When the remote controller is left untouched for 60 seconds, it returns to the normal mode.

4. Troubleshooting

4.1 Error Codes and Description

	Code Indication	Description	Reference Page
System	00	Normal	—
	U0★	Insufficient gas	102
	U2	Low-voltage detection or over-voltage detection	104
	U4	Signal transmission error (between indoor and outdoor units)	79
	U8	Unspecified voltage (between indoor and outdoor unit)	80
Indoor Unit	P1	Indoor unit PCB abnormality	73
	P5	Freeze-up protection control or high pressure control	74
	P6	Fan motor or related abnormality	76
	E4	Heat exchanger temperature thermistor abnormality	78
	E9	Room temperature thermistor abnormality	78
Outdoor Unit	E1	Outdoor unit PCB abnormality	81
	E5★	OL activation (compressor overload)	82
	E6★	Compressor lock	83
	E7	DC fan lock	84
	E8	Input overcurrent detection	85
	E9	Four-way valve abnormality	86
	F3	Discharge pipe temperature control	88
	F6	High pressure control in cooling	89
	H0	Compressor system sensor abnormality	90
	H6	Position sensor abnormality	91
	H8	CT or related abnormality	93
	H9	Outdoor air thermistor or related abnormality	95
	J3	Discharge pipe temperature thermistor or related abnormality	95
	J6	Heat exchanger temperature thermistor or related abnormality	95
	L3	Electrical box temperature rise	97
	L4	Radiation fin temperature rise	98
	L5	Output overcurrent detection	100
	P4	Heat radiation fin thermistor or related abnormality	95
	U7	Signal transmission error on outdoor unit PCB	105

★: Displayed only when system-down occurs.

4.2 Indoor Unit PCB Abnormality

Remote
Controller
Display

81

Method of
Malfunction
Detection

Evaluation of zero-cross detection of power supply by indoor unit.

Malfunction
Decision
Conditions

When there is no zero-cross detection in approximately 10 continuous seconds.

Supposed
Causes

- Faulty indoor unit PCB
- Faulty connector connection

Troubleshooting

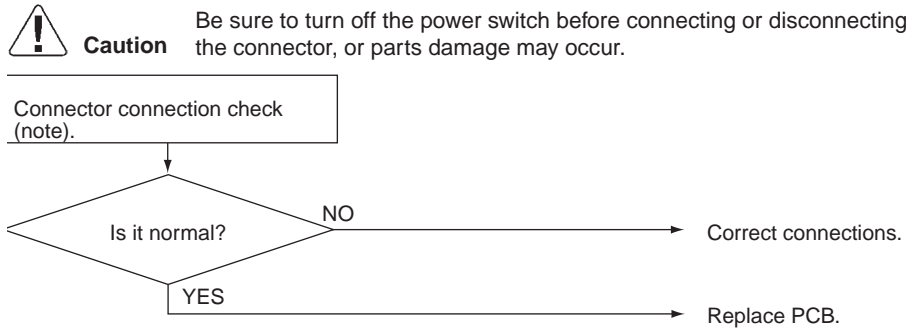

(R7130)



Note: Connector Nos. vary depending on models.

Model Type	Connector No.
Wall Mounted Type	Terminal strip~Control PCB

4.3 Freeze-up Protection Control or High Pressure Control

<p>Remote Controller Display</p>	<p style="text-align: center; font-size: 2em;">RS</p>
<p>Method of Malfunction Detection</p>	<ul style="list-style-type: none"> ■ High pressure control (heat pump model only) During heating operations, the temperature detected by the indoor heat exchanger thermistor is used for the high pressure control (stop, outdoor fan stop, etc.) ■ Freeze-up protection control (operation halt) is activated during cooling operation according to the temperature detected by the indoor unit heat exchanger thermistor.
<p>Malfunction Decision Conditions</p>	<ul style="list-style-type: none"> ■ High pressure control During heating operations, the temperature detected by the indoor heat exchanger thermistor is above 149°F(65°C) ■ Freeze-up protection When the indoor unit heat exchanger temperature is below 32°F(0°C) during cooling operation.
<p>Supposed Causes</p>	<ul style="list-style-type: none"> ■ Operation halt due to clogged air filter of the indoor unit. ■ Operation halt due to dust accumulation on the indoor unit heat exchanger. ■ Operation halt due to short-circuit. ■ Detection error due to faulty indoor unit heat exchanger thermistor. ■ Detection error due to faulty indoor unit PCB.

Troubleshooting



Check No.06
Refer to P.108

**Caution**

Be sure to turn off the power switch before connecting or disconnecting the connector, or parts damage may occur.

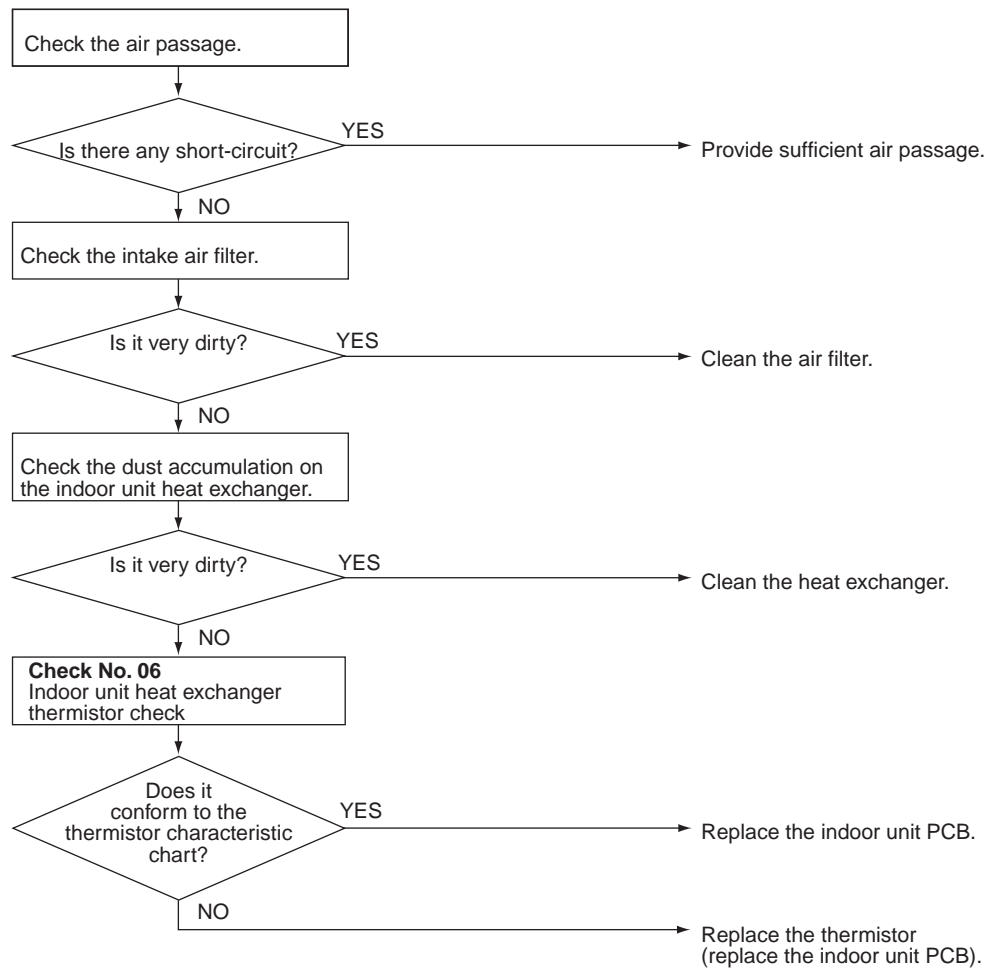

(R7131)

4.4 Fan Motor (DC Motor) or Related Abnormality

<p>Remote Controller Display</p>	<p>FE</p>
<p>Method of Malfunction Detection</p>	<p>The rotation speed detected by the Hall IC during fan motor operation is used to determine abnormal fan motor operation.</p>
<p>Malfunction Decision Conditions</p>	<p>When the detected rotation speed does not reach the demanded rotation speed of the target tap, and is less than 50% of the maximum fan motor rotation speed.</p>
<p>Supposed Causes</p>	<ul style="list-style-type: none"> ■ Operation halt due to short circuit inside the fan motor winding. ■ Operation halt due to breaking of wire inside the fan motor. ■ Operation halt due to breaking of the fan motor lead wires. ■ Operation halt due to faulty capacitor of the fan motor. ■ Detection error due to faulty indoor unit PCB.

Troubleshooting



Check No.01
Refer to P.106



Caution

Be sure to turn off the power switch before connecting or disconnecting the connector, or parts damage may occur.

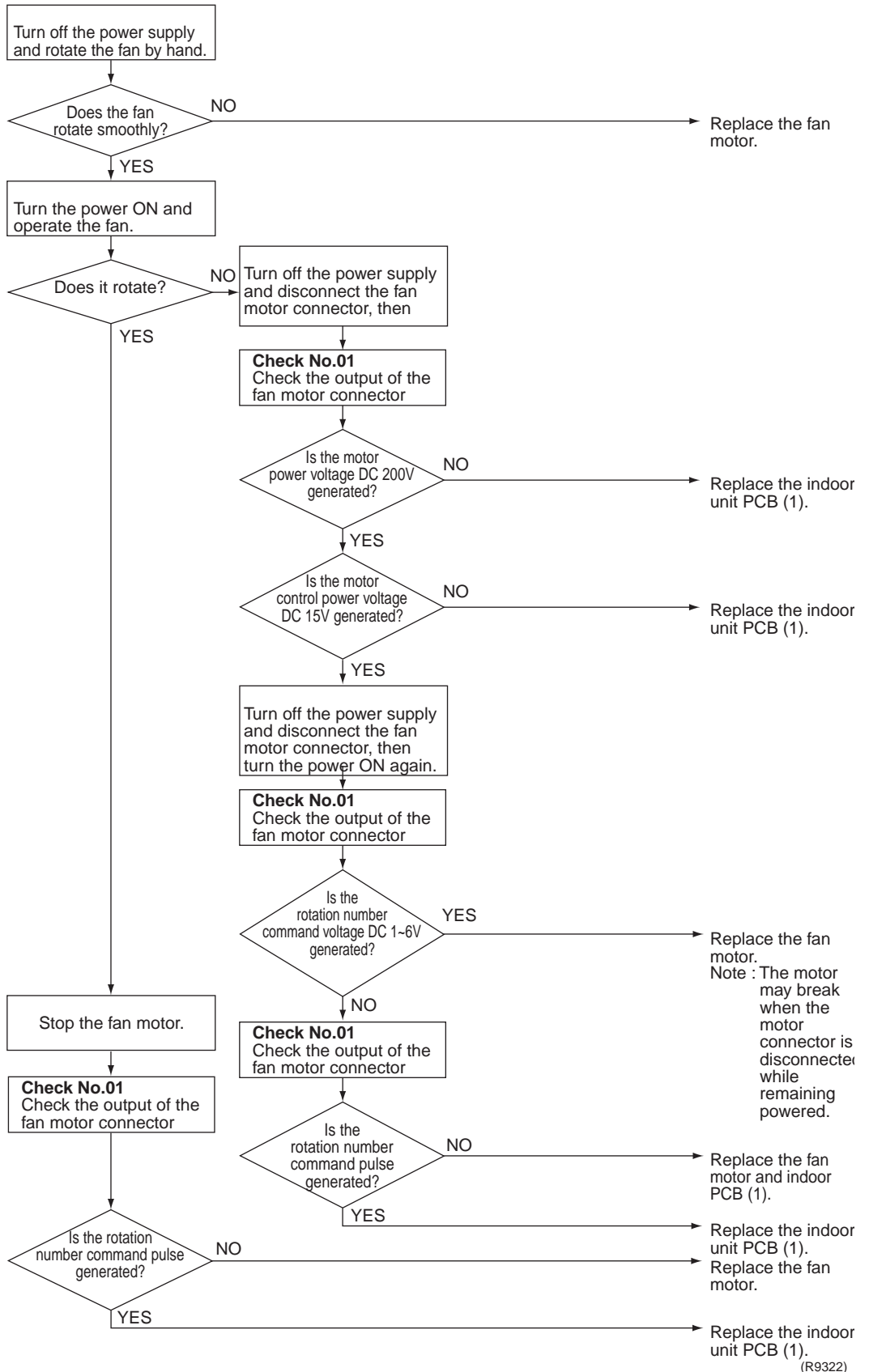

4.5 Thermistor or Related Abnormality (Indoor Unit)

Remote
Controller
Display

Ⓔ4,Ⓔ9

Method of
Malfunction
Detection

The temperatures detected by the thermistors are used to determine thermistor errors.

Malfunction
Decision
Conditions

When the thermistor input is more than 4.96 V or less than 0.04 V during compressor operation*.
* (reference)

When above about 413.6°F(212°C) (less than 120 Ω) or below about -58°F(-50°C) (more than 1,860 kΩ).



Note: The values vary slightly in some models.

Supposed
Causes

- Faulty connector connection
- Faulty thermistor
- Faulty PCB

Troubleshooting



Check No.06
Refer to P.108



Caution

Be sure to turn off the power switch before connecting or disconnecting the connector, or parts damage may occur.

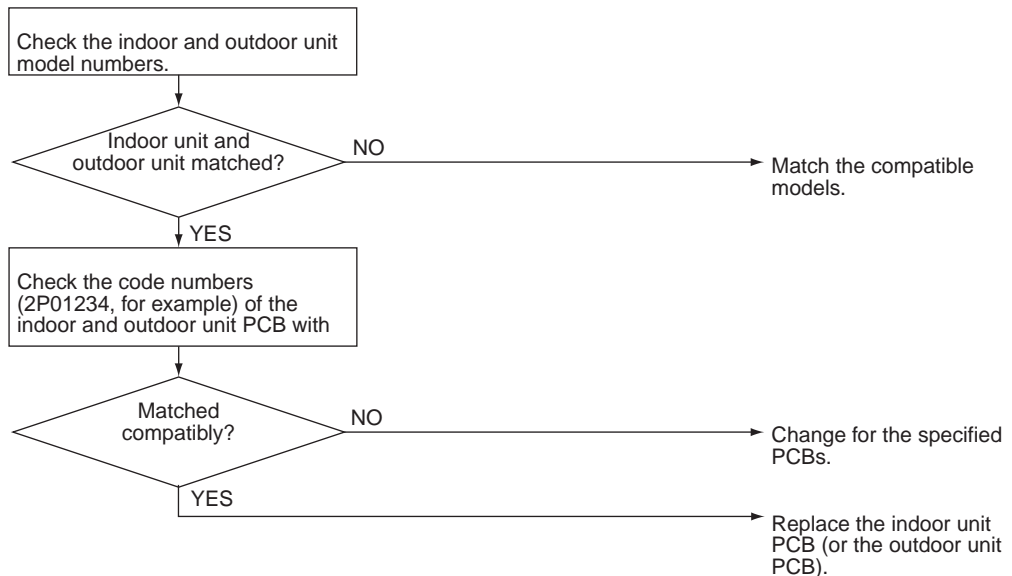

Ⓔ4 : Heat exchanger thermistor
Ⓔ9 : Room temperature thermistor

4.6 Signal Transmission Error (between Indoor and Outdoor Unit)

Remote Controller Display



Method of Malfunction Detection

The data received from the outdoor unit in indoor unit-outdoor unit signal transmission is checked whether it is normal.

Malfunction Decision Conditions

When the data sent from the outdoor unit cannot be received normally, or when the content of the data is abnormal.

Supposed Causes

- Faulty outdoor unit PCB / Faulty indoor unit PCB
- Indoor unit-outdoor unit signal transmission error due to wiring error / due to disturbed power supply waveform / due to breaking of wire in the connection wires between the indoor and outdoor units (wire No. 3)
- Short circuit inside the fan motor winding

Troubleshooting



Check No.10
Refer to P.110

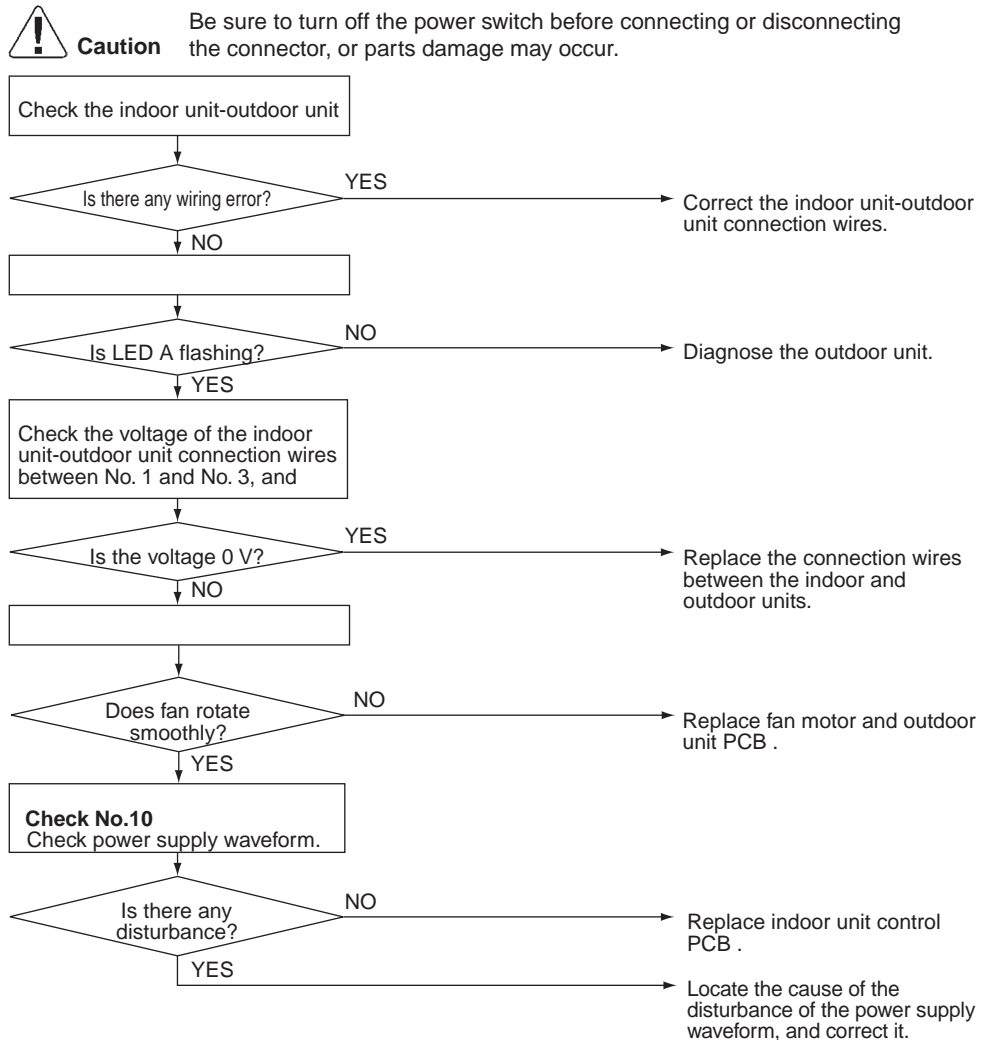

(R8300)

4.7 Unspecified Voltage (between Indoor and Outdoor Units)

Remote
Controller
Display



Method of
Malfunction
Detection

The supply power is detected for its requirements (different from pair type and multi type) by the indoor / outdoor transmission signal.

Malfunction
Decision
Conditions

The pair type and multi type are interconnected.

Supposed
Causes

- Wrong models interconnected
- Wrong indoor unit PCB mounted
- Indoor unit PCB defective
- Wrong outdoor unit PCB mounted or defective

Troubleshooting

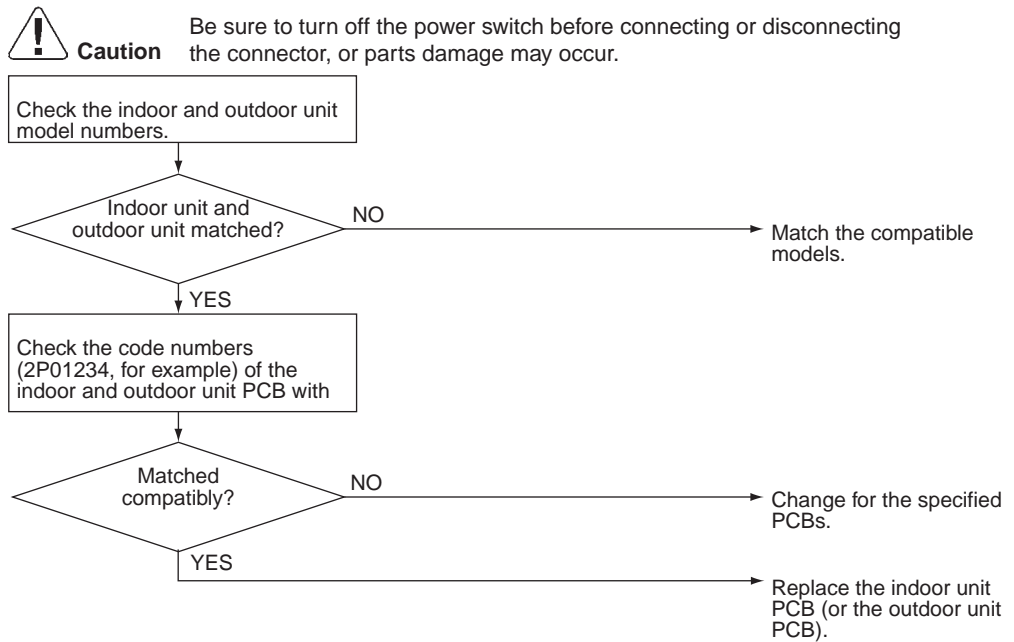

(R8308)

4.8 Outdoor Unit PCB Abnormality

Remote
Controller
Display

E I

Method of
Malfunction
Detection

- Detect within the program of the microcomputer that the program is in normal running order.

Malfunction
Decision
Conditions

- When the program of the microcomputer is in abnormal running order.

Supposed
Causes

- Out of control of microcomputer caused by external factors
 - Noise
 - Momentary drop in voltage
 - Momentary power loss
- Defective outdoor unit PCB

Troubleshooting



Caution

Be sure to turn off the power switch before connecting or disconnecting the connector, or parts damage may occur.

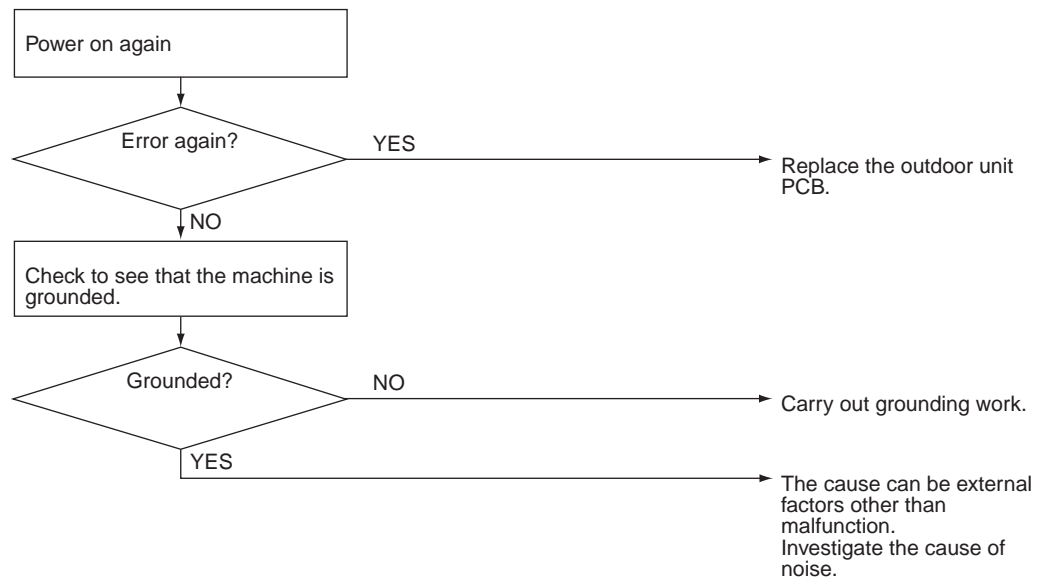

(R7183)

4.9 OL Activation (Compressor Overload)

Remote
Controller
Display

ES

Method of
Malfunction
Detection

A compressor overload is detected through compressor OL.

Malfunction
Decision
Conditions

- If the compressor OL is activated twice, the system will be shut down.
 - The error counter will reset itself if this or any other error does not occur during the following 60-minute compressor running time (total time).
- * The operating temperature condition is not specified.

Supposed
Causes

- Refrigerant shortage
- Four-way valve malfunctioning
- Outdoor unit PCB defective
- Water mixed in the local piping
- Electronic expansion valve defective
- Stop valve defective

Troubleshooting



Check No.04
Refer to P.106



Check No.05
Refer to P.107



Check No.06
Refer to P.108



Check No.11
Refer to P.110



Caution Be sure to turn off the power switch before connecting or disconnecting the connector, or parts damage may occur.

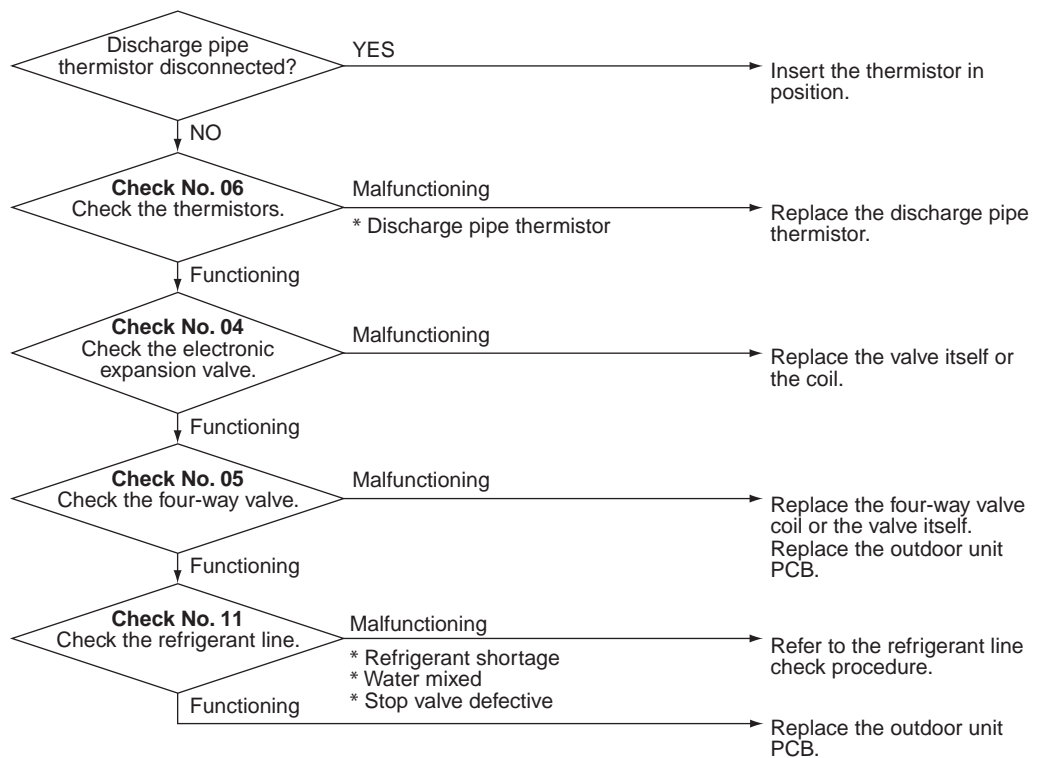

(R7137)

4.10 Compressor Lock

Remote
Controller
Display



Method of
Malfunction
Detection

A compressor lock is detected by checking the compressor running condition through the position detection circuit.

Malfunction
Decision
Conditions

- Judging from current waveform generated when applying high-frequency voltage to the motor.
- The system will be shut down if the error occurs 16 times.
- Clearing condition: Continuous run for about 5 minutes (normal)

Supposed
Causes

- Compressor locked
- Compressor harness disconnected

Troubleshooting



Caution

Be sure to turn off the power switch before connecting or disconnecting the connector, or parts damage may occur.
(Precaution before turning on the power again)
Make sure the power has been off for at least 30 seconds.

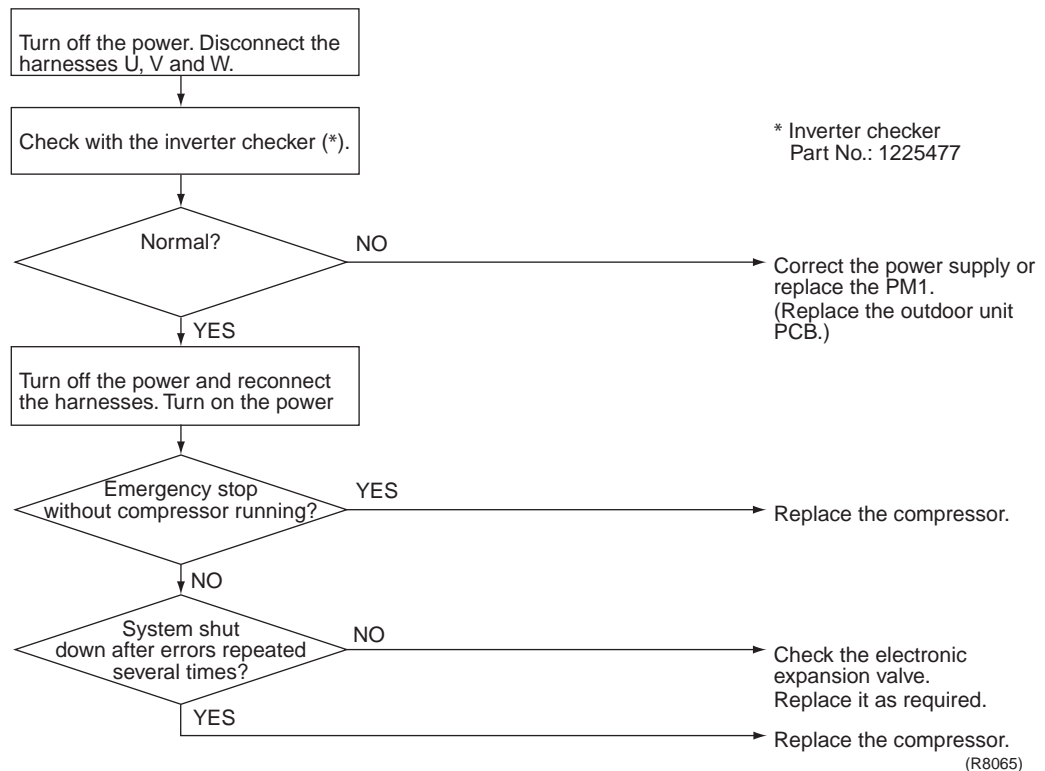

4.11 DC Fan Lock

Remote
Controller
Display



Method of
Malfunction
Detection

A fan motor or related error is detected by checking the high-voltage fan motor rpm being detected by the Hall IC.

Malfunction
Decision
Conditions

- The fan does not start in 30 seconds even when the fan motor is running.
- The system will be shut down if the error occurs 16 times.
- Clearing condition: Continuous run for about 5 minutes (normal)

Supposed
Causes

- Fan motor breakdown
- Harness or connector disconnected between fan motor and PCB or in poor contact
- Foreign matter stuck in the fan

Troubleshooting



Check No.15
Refer to P.112

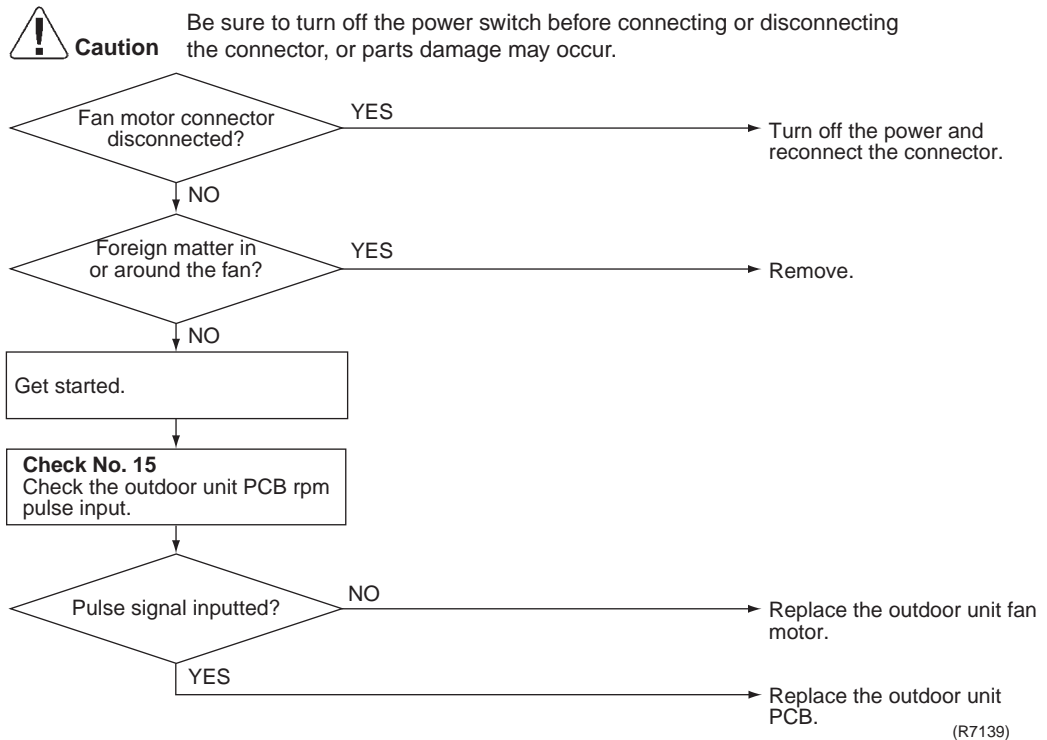

4.12 Input Overcurrent Detection

Remote
Controller
Display



Method of
Malfunction
Detection

An input overcurrent is detected by checking the input current value being detected by CT with the compressor running.

Malfunction
Decision
Conditions

- The following CT input with the compressor running continues for 2.5 seconds.
CT input : Above 20 A
- The system will be shut down if the error occurs 16 times.
- Clearing condition : Continuous run for about 5 minutes (normal)

Supposed
Causes

- Overcurrent due to compressor failure
- Overcurrent due to defective power transistor
- Overcurrent due to defective inverter main circuit electrolytic capacitor
- Overcurrent due to defective outdoor unit PCB
- Error detection due to outdoor unit PCB
- Overcurrent due to short-circuit

Troubleshooting



Check No.07
Refer to P.109



Check No.08
Refer to P.109



Caution Be sure to turn off the power switch before connecting or disconnecting the connector, or parts damage may occur.

* An input overcurrent may result from wrong internal wiring. If the wires have been disconnected and reconnected for part replacement, for example, and the system is interrupted by an input over-current, check the wires again.

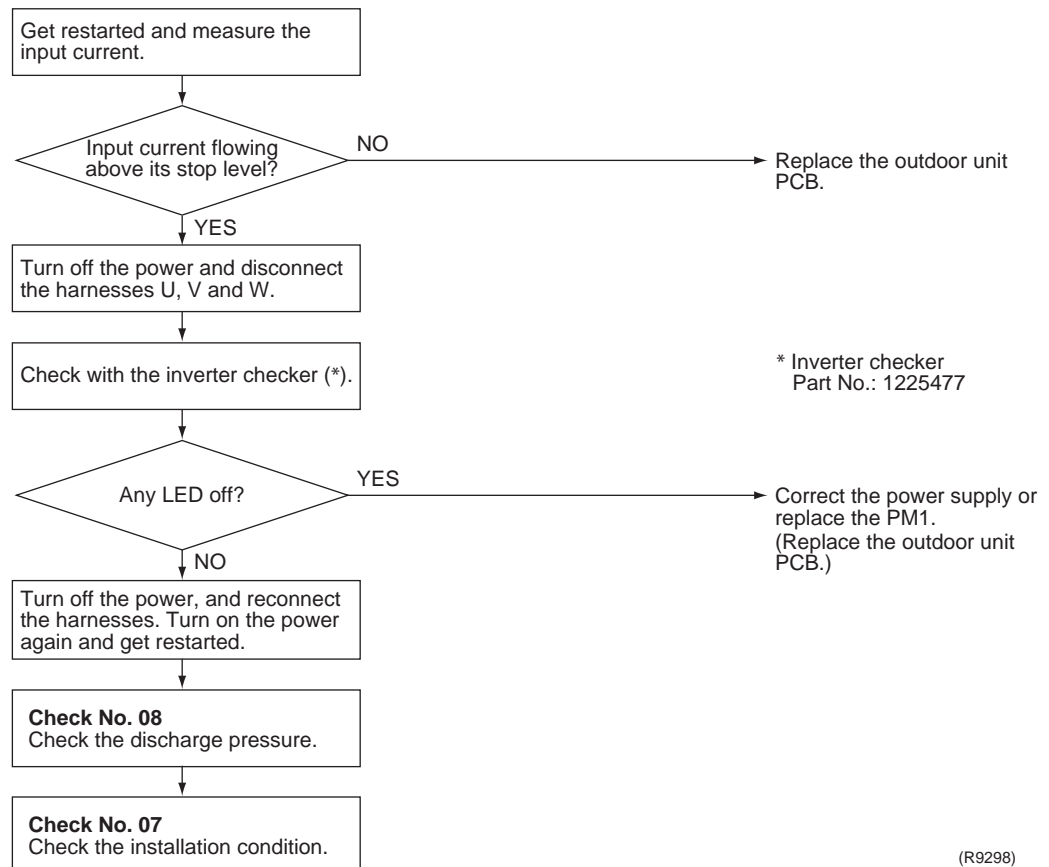

(R9298)

4.13 Four-Way Valve Abnormality

Remote
Controller
Display

EA

**Method of
Malfunction
Detection**

The room temperature thermistor, the indoor unit heat exchanger thermistor, the outdoor temperature thermistor and the outdoor unit heat exchanger thermistor are checked to see if they function within their normal ranges in the operating mode.

**Malfunction
Decision
Conditions**

A following condition continues over 1 minute after operating 10 minutes.

- Cooling / dry operation
(room temp. – indoor heat exchanger temp.) < -9°F(-5°C)
- Heating
(indoor unit heat exchanger temp. – room temp.) < -9°F(-5°C)
- The system will be shut down if the cooling / heating changeover abnormality occurs 5 times.

**Supposed
Causes**

- Connector in poor contact
- Thermistor defective
- Outdoor unit PCB defective
- Four-way valve coil or harness defective
- Four-way valve defective
- Foreign substance mixed in refrigerant
- Insufficient gas

Troubleshooting



Check No.05
Refer to P.107



Check No.06
Refer to P.108



Check No.11
Refer to P.110



Caution Be sure to turn off the power switch before connecting or disconnecting the connector, or parts damage may occur.

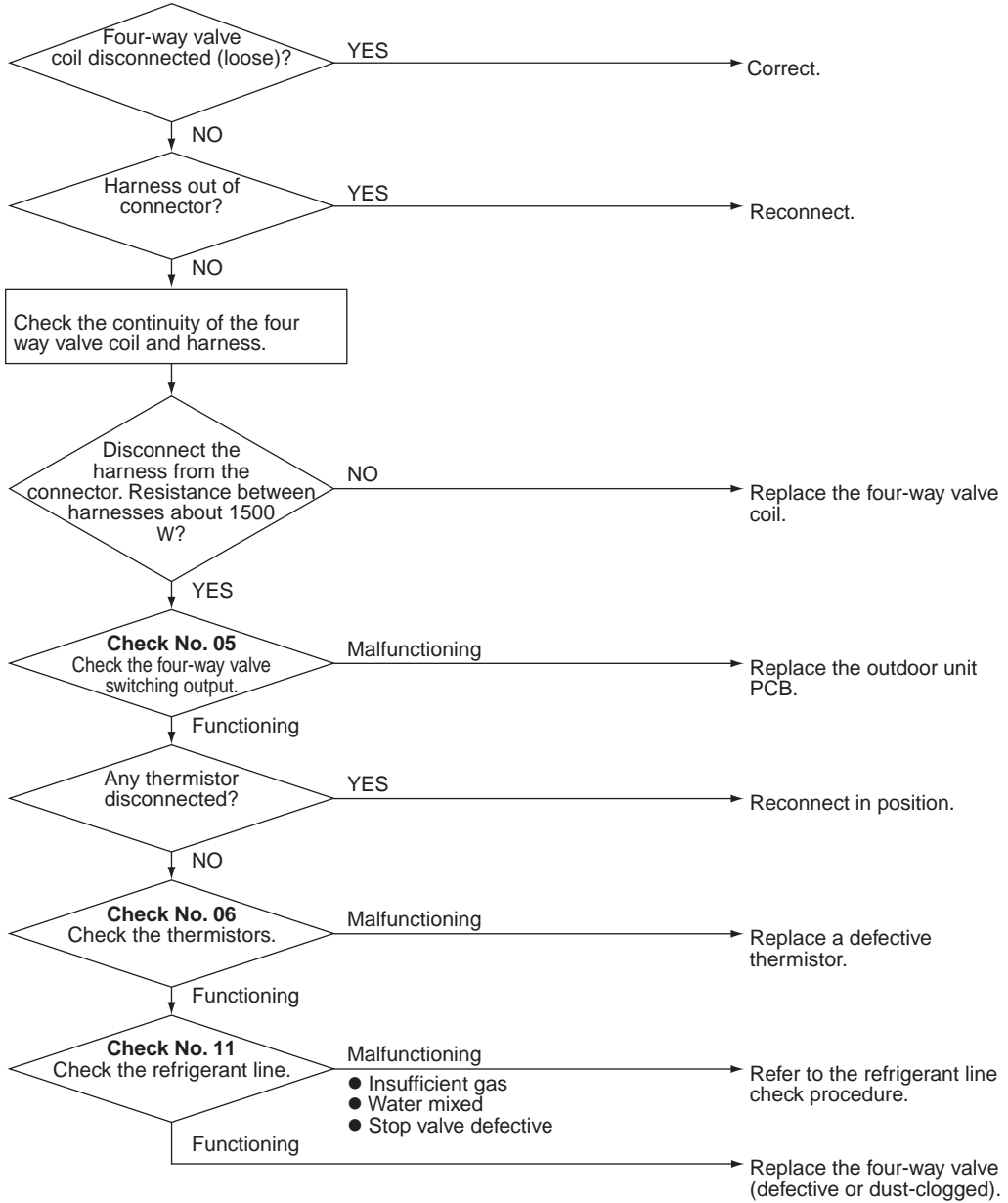

(R7272)

4.14 Discharge Pipe Temperature Control

Remote
Controller
Display



Method of
Malfunction
Detection

The discharge pipe temperature control (stop, frequency dropping, etc.) is checked with the temperature being detected by the discharge pipe thermistor.

Malfunction
Decision
Conditions

- If a stop takes place 6 times successively due to abnormal discharge pipe temperature, the system will be shut down.
- If the temperature being detected by the discharge pipe thermistor rises above Δ , the compressor will stop. (The error is cleared when the temperature has dropped below \square .)

Δ	248.0°F(120°C)
\square	224.6°F(107°C)

- The error counter will reset itself if this or any other error does not occur during the following 60-minute compressor running time (total time).

Supposed
Causes

- Refrigerant shortage
- Four-way valve malfunctioning
- Discharge pipe thermistor defective (heat exchanger or outdoor temperature thermistor defective)
- Outdoor unit PCB defective
- Water mixed in the local piping
- Electronic expansion valve defective
- Stop valve defective

Troubleshooting



Check No.04
Refer to P.106



Check No.06
Refer to P.108



Check No.11
Refer to P.110



Caution

Be sure to turn off the power switch before connecting or disconnecting the connector, or parts damage may occur.

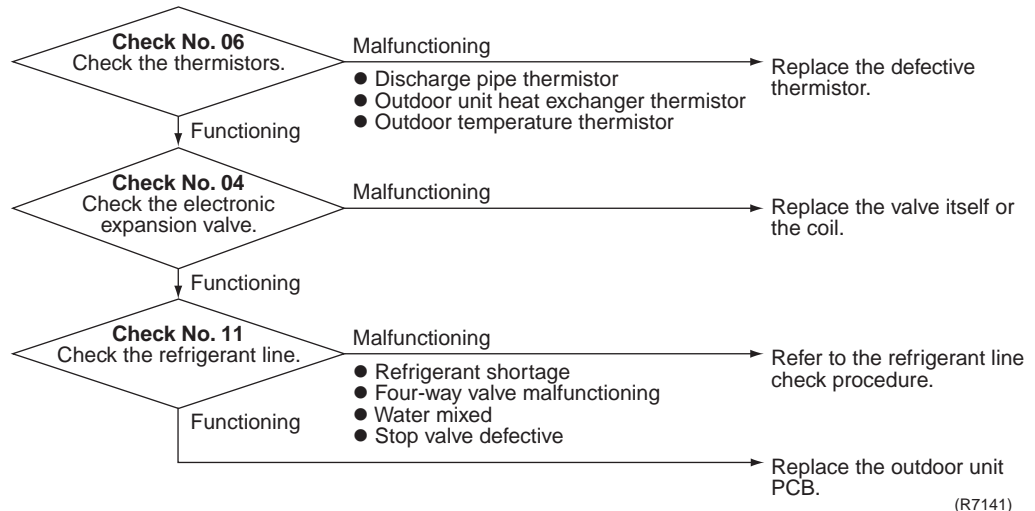

(R7141)

4.15 High Pressure Control in Cooling

Remote
Controller
Display



Method of
Malfunction
Detection

High-pressure control (stop, frequency drop, etc.) is activated in the cooling mode if the temperature being sensed by the heat exchanger thermistor exceeds the limit.

Malfunction
Decision
Conditions

- Activated when the temperature being sensed by the heat exchanger thermistor rises above 149°F(65°C).
- The error is cleared when the temperature drops below 122°F(50°C).

Supposed
Causes

- The installation space is not large enough.
- Faulty outdoor unit fan
- Faulty electronic expansion valve
- Faulty defrost thermistor
- Faulty outdoor unit PCB
- Faulty stop valve
- Dirty heat exchanger
- Foreign matter stuck in the outdoor unit fan

Troubleshooting



Caution Be sure to turn off the power switch before connecting or disconnecting the connector, or parts damage may occur.

- Check No.04**
Refer to P.106
- Check No.06**
Refer to P.108
- Check No.07**
Refer to P.109
- Check No.09**
Refer to P.110

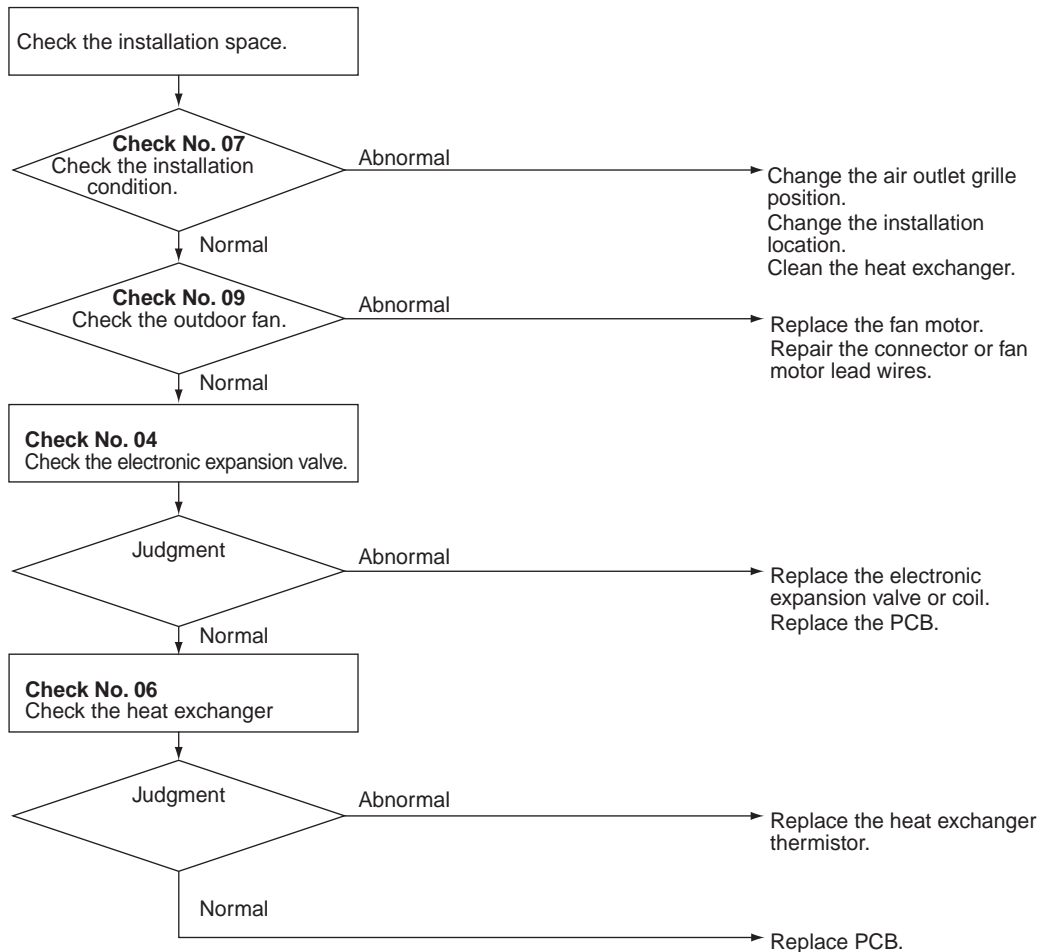

(R7142)

4.16 Compressor System Sensor Abnormality

Remote
Controller
Display



Method of
Malfunction
Detection

- Fault condition is identified by the supply voltage and the DC voltage which is detected before the compressor startup.
- Fault condition is identified by compressor current which is detected right after the compressor startup.

Malfunction
Decision
Conditions

- The detected value of the supply voltage and the DC voltage is obviously low or high.
- The compressor current does not run when the compressor is started.

Supposed
Causes

- Reactor disconnection
- Compressor disconnection
- Outdoor unit PCB defective
- Compressor defective

Troubleshooting

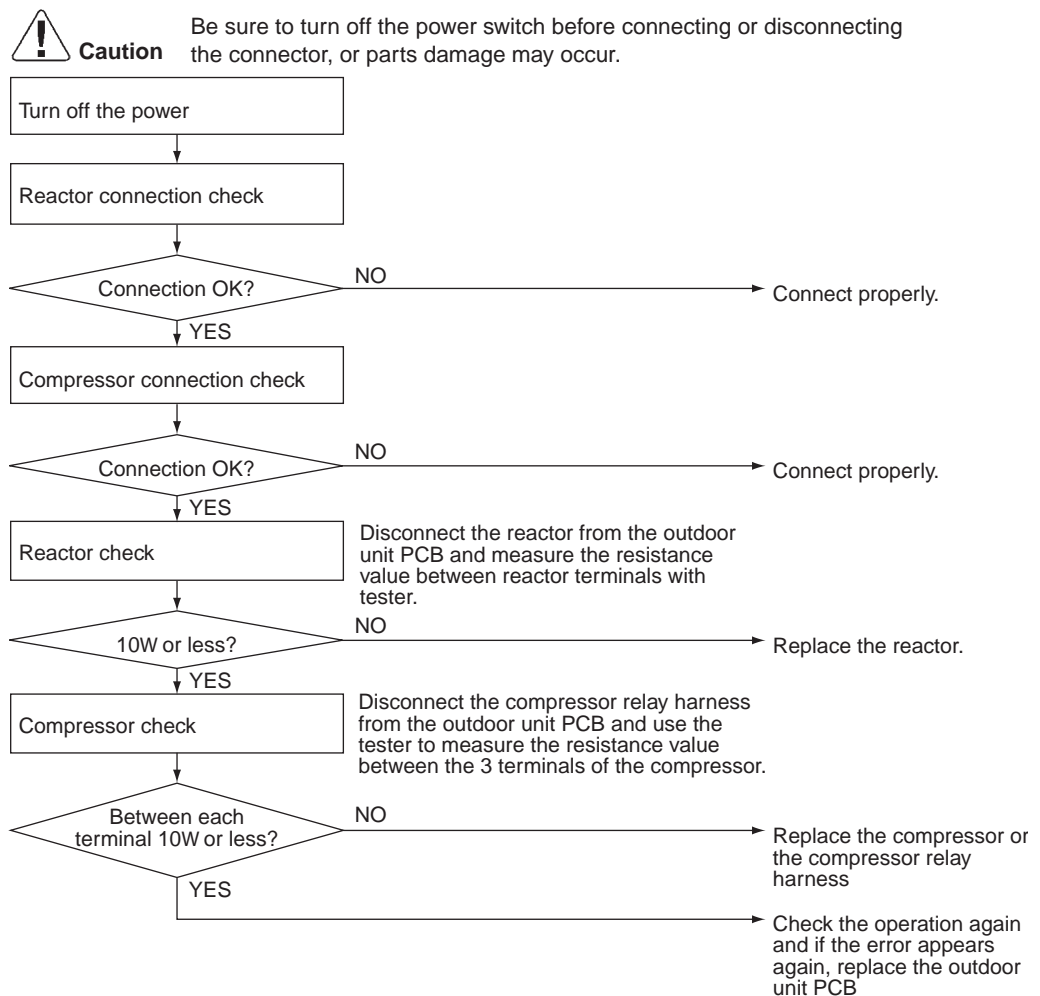

4.17 Position Sensor Abnormality

Remote
Controller
Display



Method of
Malfunction
Detection

A compressor startup failure is detected by checking the compressor running condition through the position detection circuit.

Malfunction
Decision
Conditions

- The compressor fails to start in about 15 seconds after the compressor run command signal is sent.
 - Clearing condition: Continuous run for about 5 minutes.
 - The system will be shut down if the error occurs 8 times.
-

Supposed
Causes

- Compressor relay cable disconnected
- Compressor itself defective
- Outdoor unit PCB defective
- Stop valve closed
- Input voltage out of specification

Troubleshooting



Check No.13
Refer to P.111



Caution Be sure to turn off the power switch before connecting or disconnecting the connector, or parts damage may occur.

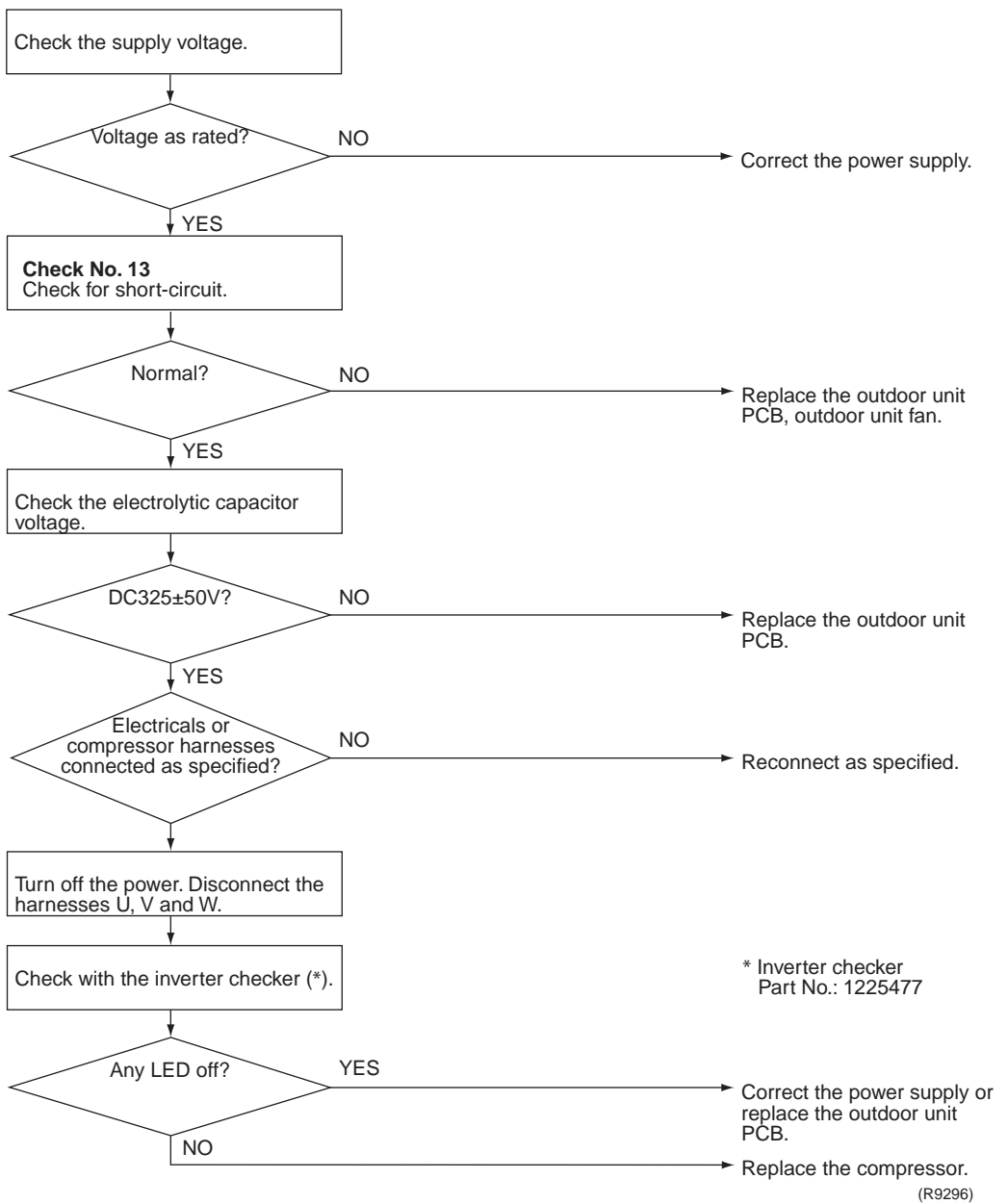

4.18 CT or Related Abnormality

Remote
Controller
Display

H8

**Method of
Malfunction
Detection**

A CT or related error is detected by checking the compressor running frequency and CT-detected input current.

**Malfunction
Decision
Conditions**

The compressor running frequency is below 32 Hz.
(The input current is also below 0.5 A.)

- If this error repeats 4 times, the system will be shut down.
 - The error counter will reset itself if this or any other error does not occur during the following 60-minute compressor running time (total time).
-

**Supposed
Causes**

- Power transistor defective
- Internal wiring broken or in poor contact
- Reactor defective
- Outdoor unit PCB defective

Troubleshooting



Check No.12
Refer to P.111



Caution Be sure to turn off the power switch before connecting or disconnecting the connector, or parts damage may occur.

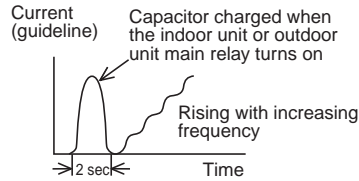
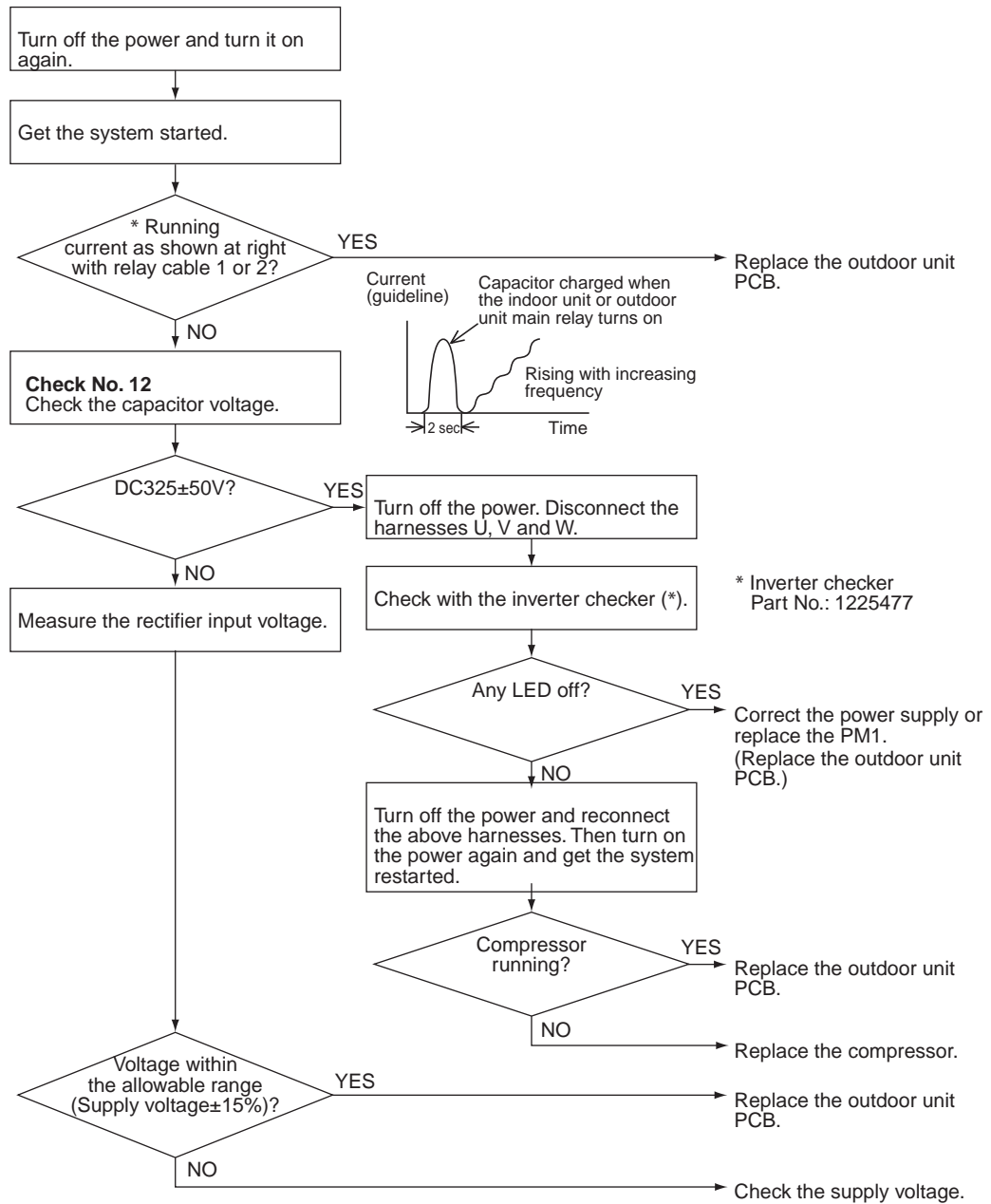

* Inverter checker
Part No.: 1225477

(R9293)

4.19 Thermistor or Related Abnormality (Outdoor Unit)

Remote
Controller
Display

P4, U3, U6, H9

Method of
Malfunction
Detection

This type of error is detected by checking the thermistor input voltage to the microcomputer.
[A thermistor error is detected by checking the temperature.]

Malfunction
Decision
Conditions

The thermistor input is above 4.96 V or below 0.04 V with the power on.
Error U3 is judged if the discharge pipe thermistor temperature is smaller than the condenser thermistor temperature.

Supposed
Causes

- Connector in poor contact
- Thermistor defective
- Outdoor unit PCB defective
- Indoor unit PCB defective
- Heat exchanger thermistor defective in the case of U3 error (outdoor unit heat exchanger thermistor in the cooling mode, or indoor unit heat exchanger thermistor in the heating mode)

Troubleshooting



Check No.06
Refer to P.108



Caution Be sure to turn off the power switch before connecting or disconnecting the connector, or parts damage may occur.

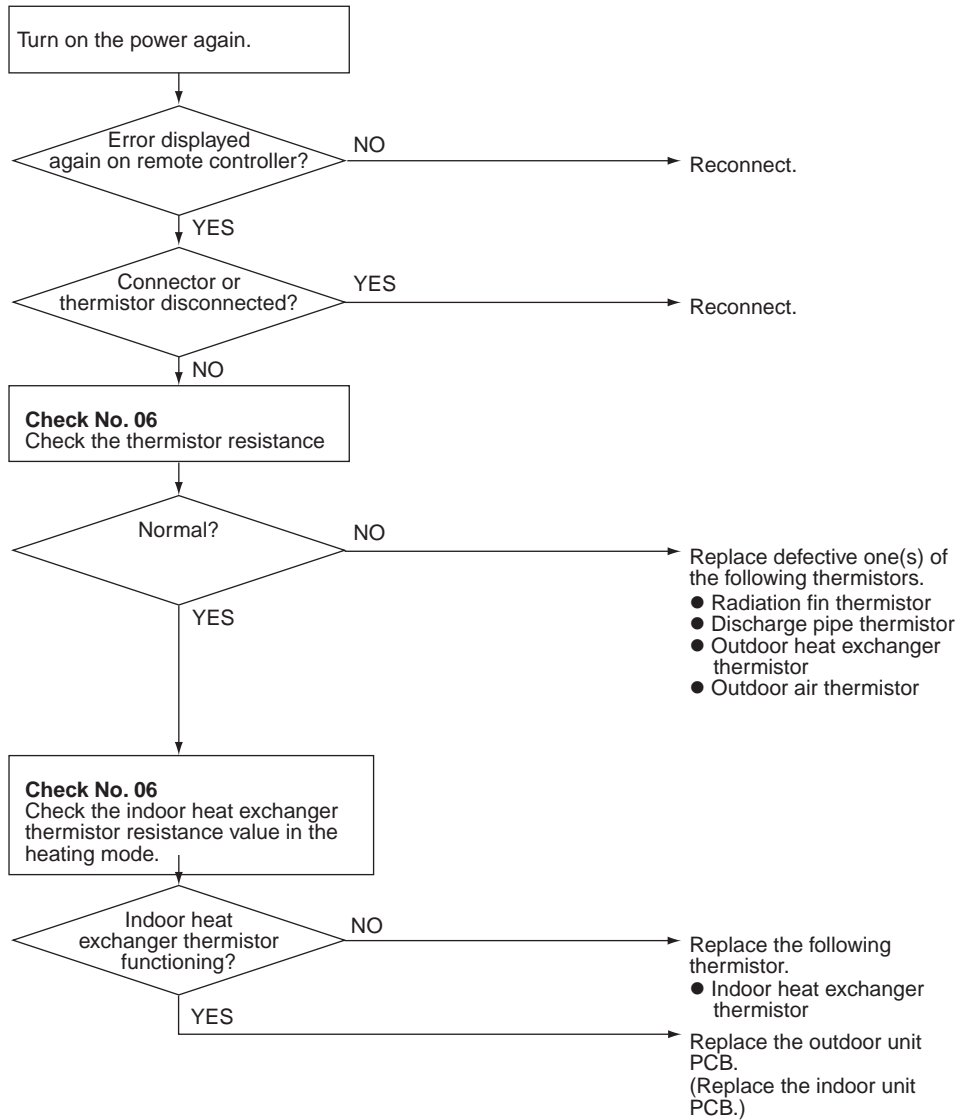

(R7346)

- P4 : Radiation fin thermistor
- U3 : Discharge pipe thermistor
- U5 : Outdoor heat exchanger thermistor
- U8 : Outdoor air temperature thermistor

4.20 Electrical Box Temperature Rise

Remote
Controller
Display



Method of
Malfunction
Detection

An electrical box temperature rise is detected by checking the radiation fin thermistor with the compressor off.

Malfunction
Decision
Conditions

With the compressor off, the radiation fin temperature is above 212°F(100°C). (Reset is made when the temperature drops below 158°F(70°C).)

Supposed
Causes

- Fin temperature rise due to defective outdoor unit fan
- Fin temperature rise due to short-circuit
- Fin thermistor defective
- Connector in poor contact
- Outdoor unit PCB defective
- Foreign matter stuck in the outdoor unit fan

Troubleshooting

Check No.07
Refer to P.109

Check No.09
Refer to P.110

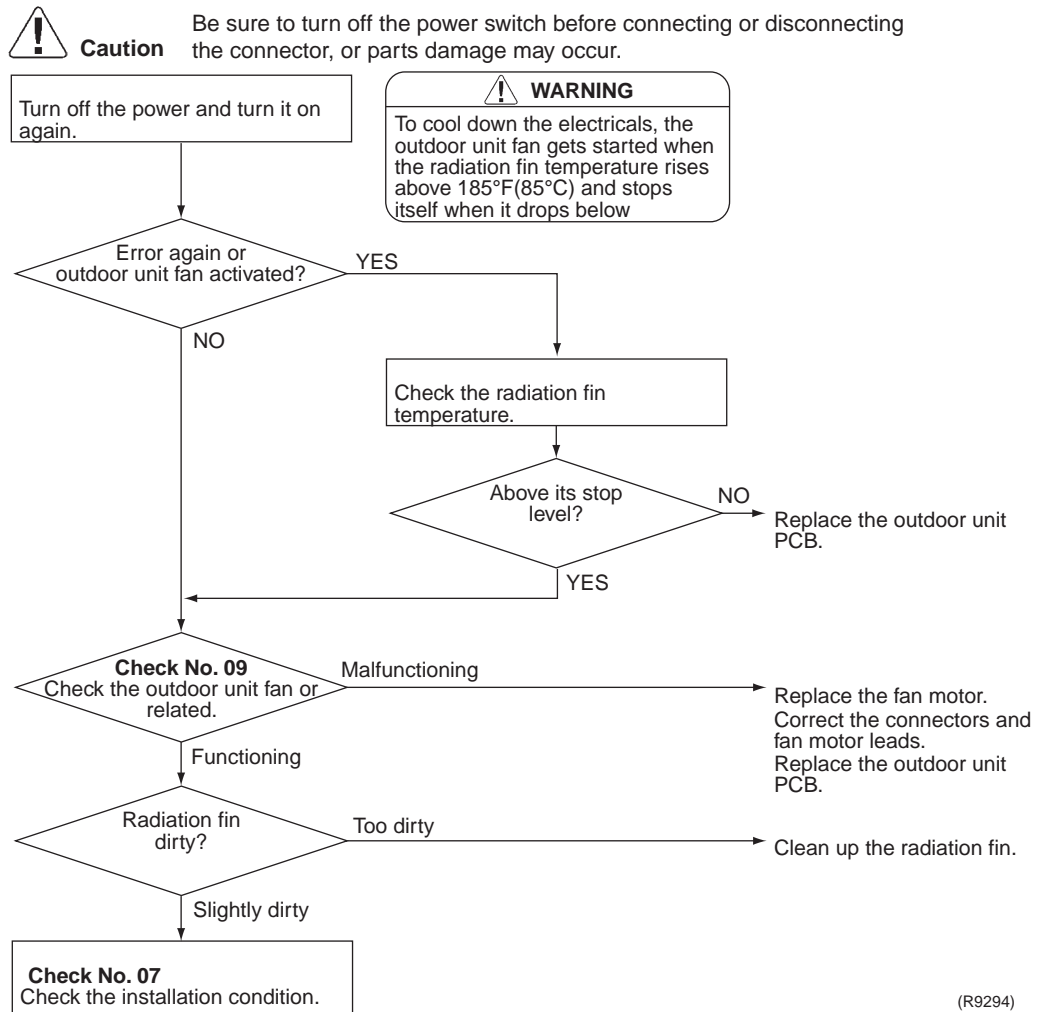

4.21 Radiation Fin Temperature Rise

Remote
Controller
Display

L4

Method of
Malfunction
Detection

A radiation fin temperature rise is detected by checking the radiation fin thermistor with the compressor on.

Malfunction
Decision
Conditions

- The radiation fin temperature with the compressor on is above 221°F(105°C).
- The error is cleared when the temperature drops below 206.6°F(97°C).
- If a radiation fin temperature rise takes place 4 times successively, the system will be shut down.
- The error counter will reset itself if this or any other error does not occur during the following 60-minute compressor running time (total time).

Supposed
Causes

- Fin temperature rise due to defective outdoor unit fan
- Fin temperature rise due to short-circuit
- Fin thermistor defective
- Connector in poor contact
- Outdoor unit PCB defective
- Silicon grease is not applied properly on the heat radiation fin after replacing outdoor unit PCB
- Foreign matter stuck in the outdoor unit fan

Troubleshooting



Check No.07
Refer to P.109



Check No.09

Refer to P.110

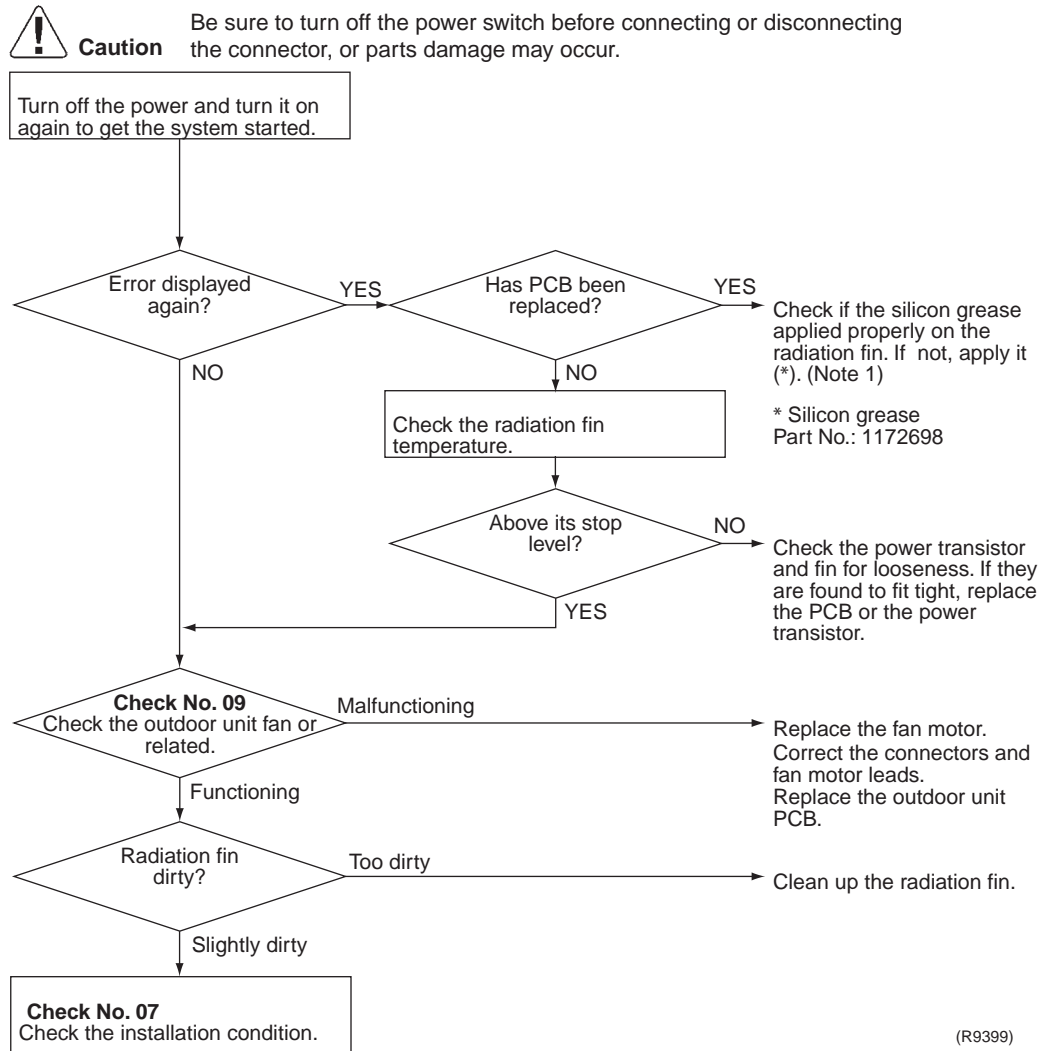

Note: Refer to "1.3 Application of Silicon grease to a power transistor and a diode bridge" on P 185.

4.22 Output Overcurrent Detection

Remote
Controller
Display

LS

Method of
Malfunction
Detection

An output overcurrent is detected by checking the current that flows in the inverter DC section.

Malfunction
Decision
Conditions

- A position signal error occurs while the compressor is running.
- A speed error occurs while the compressor is running.
- An output overcurrent input is fed from the output overcurrent detection circuit to the microcomputer.
- The system will be shut down if the error occurs 16 times.
- Clearing condition: Continuous run for about 5 minutes (normal)

Supposed
Causes

- Overcurrent due to defective power transistor
- Overcurrent due to wrong internal wiring
- Overcurrent due to abnormal supply voltage
- Overcurrent due to defective PCB
- Error detection due to defective PCB
- Overcurrent due to closed stop valve
- Overcurrent due to compressor failure
- Overcurrent due to poor installation condition
- Overcurrent due to outdoor unit fan lock

Troubleshooting

Check No.07
 Refer to P.109



Check No.08
 Refer to P.109

Check No.13
 Refer to P.111

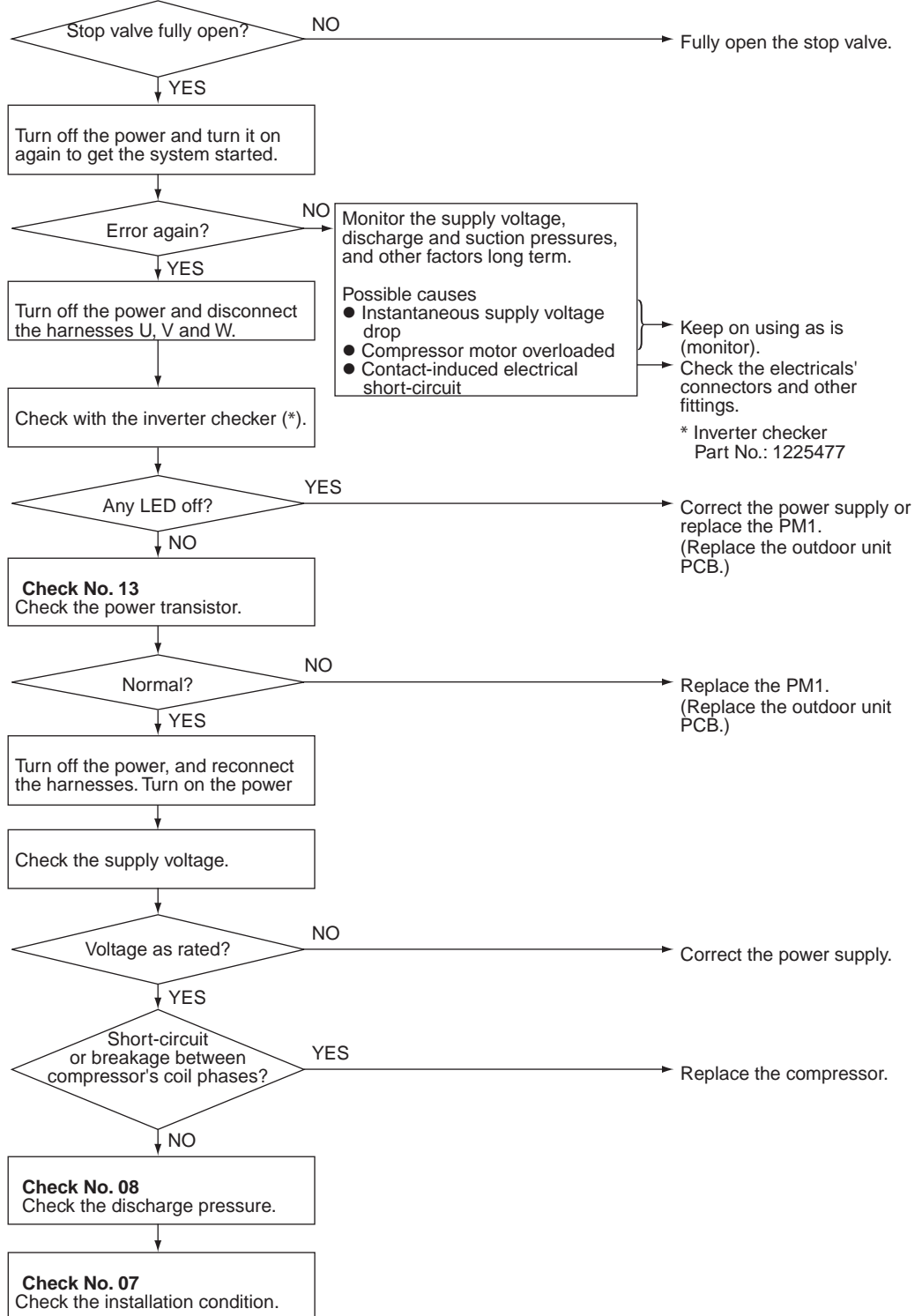

Caution Be sure to turn off the power switch before connecting or disconnecting the connector, or parts damage may occur.

* An output overcurrent may result from wrong internal wiring. If the wires have been disconnected and reconnected for parts replacements, for example, and the system is interrupted by an output overcurrent, take the following procedure:



(R8071)

4.23 Insufficient Gas

Remote
Controller
Display



Method of
Malfunction
Detection

Gas shortage detection I :

A gas shortage is detected by checking the CT-detected input current value and the compressor running frequency.

Gas shortage detection II :

A gas shortage is detected by checking the difference between indoor unit heat exchanger temperature and room temperature as well as the difference between outdoor unit heat exchanger temperature and room temperature.

Malfunction
Decision
Conditions

Gas shortage detection I :

DC current \leq A (A/Hz) Output frequency + B

However, when the status of running frequency > 40 (Hz) is kept on for a certain time.

Note : The values are different from model to model.

	A	B
30/36 class	27 / 1000	2

Gas shortage detection II :

Electronic expansion valve opening \geq A (pulse)

Discharge pipe temperature(°C) \geq B target discharge pipe temperature(°C) + C (°C)

	A	B	C
30/36 class	480	128/128	Cooling: 50, Heating: 45

If a gas shortage error takes place 4 times successively, the system will be shut down. The error counter will reset itself if this or any other error does not occur during the following 60-minute compressor running time (total time).

Supposed
Causes

- Refrigerant shortage (refrigerant leakage)
- Poor compression performance of compressor
- Discharge pipe thermistor disconnected, or indoor unit or outdoor unit heat exchanger thermistor disconnected, room or outside air temperature thermistor disconnected
- Stop valve closed
- Electronic expansion valve defective

Troubleshooting



Check No.04
Refer to P.106



Check No.06
Refer to P.108



Caution Be sure to turn off the power switch before connecting or disconnecting the connector, or parts damage may occur.

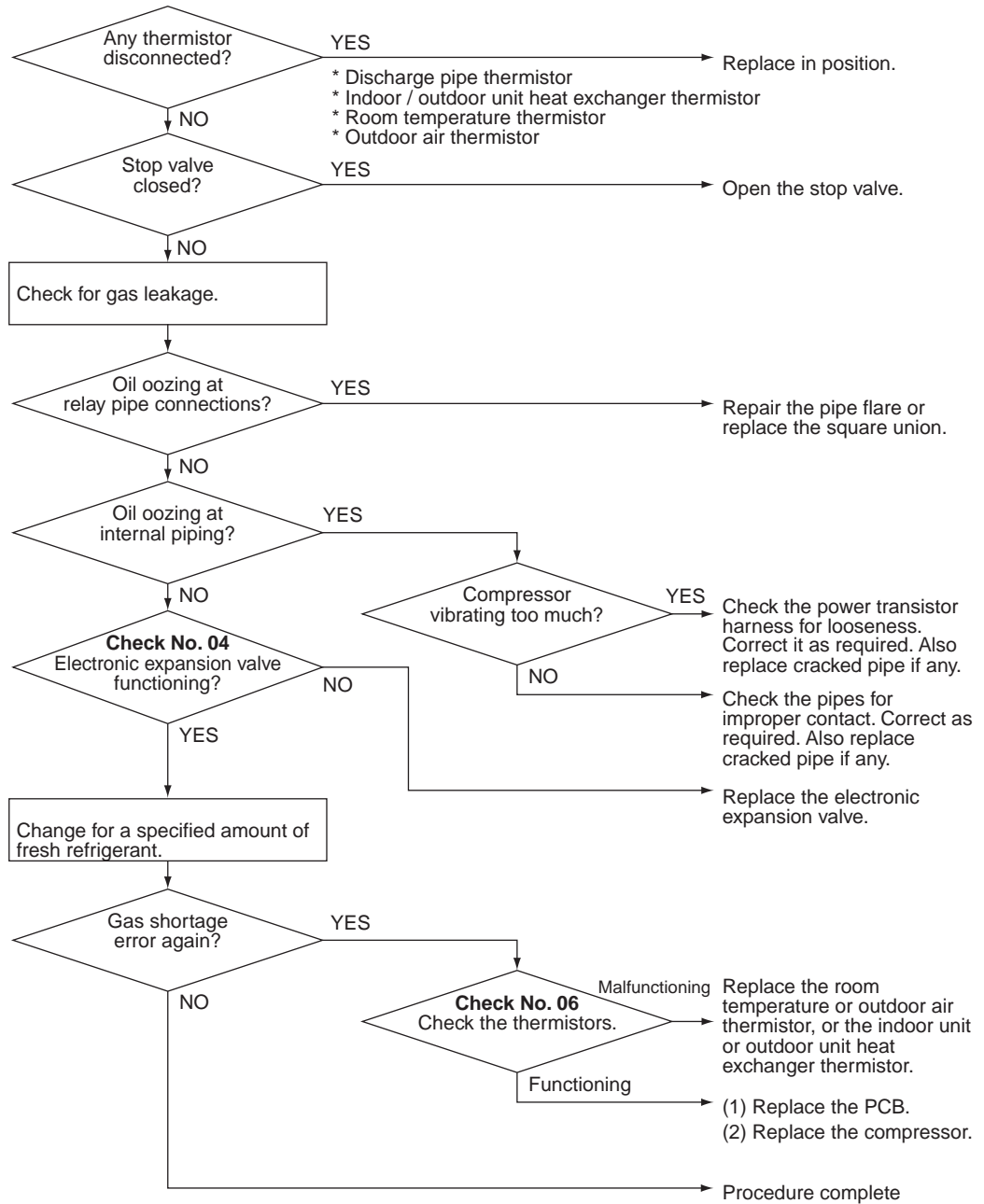

(R7149)

4.24 Low-voltage Detection or Over-voltage Detection

Remote
Controller
Display



Method of
Malfunction
Detection

An abnormal voltage rise or drop is detected by checking the detection circuit or DC voltage detection circuit.

Malfunction
Decision
Conditions

- An over-voltage signal is fed from the over-voltage detection circuit to the microcomputer, or the voltage being detected by the DC voltage detection circuit is judged to be below 150 V for 0.1 second.
- The system will be shut down if the error occurs 16 times.
- Clearing condition: Continuous run for about 60 minutes. (normal)

Supposed
Causes

- Supply voltage not as specified
- Over-voltage detector or DC voltage detection circuit defective
- PAM control part(s) defective
- Short circuit inside the fan motor winding.

Troubleshooting

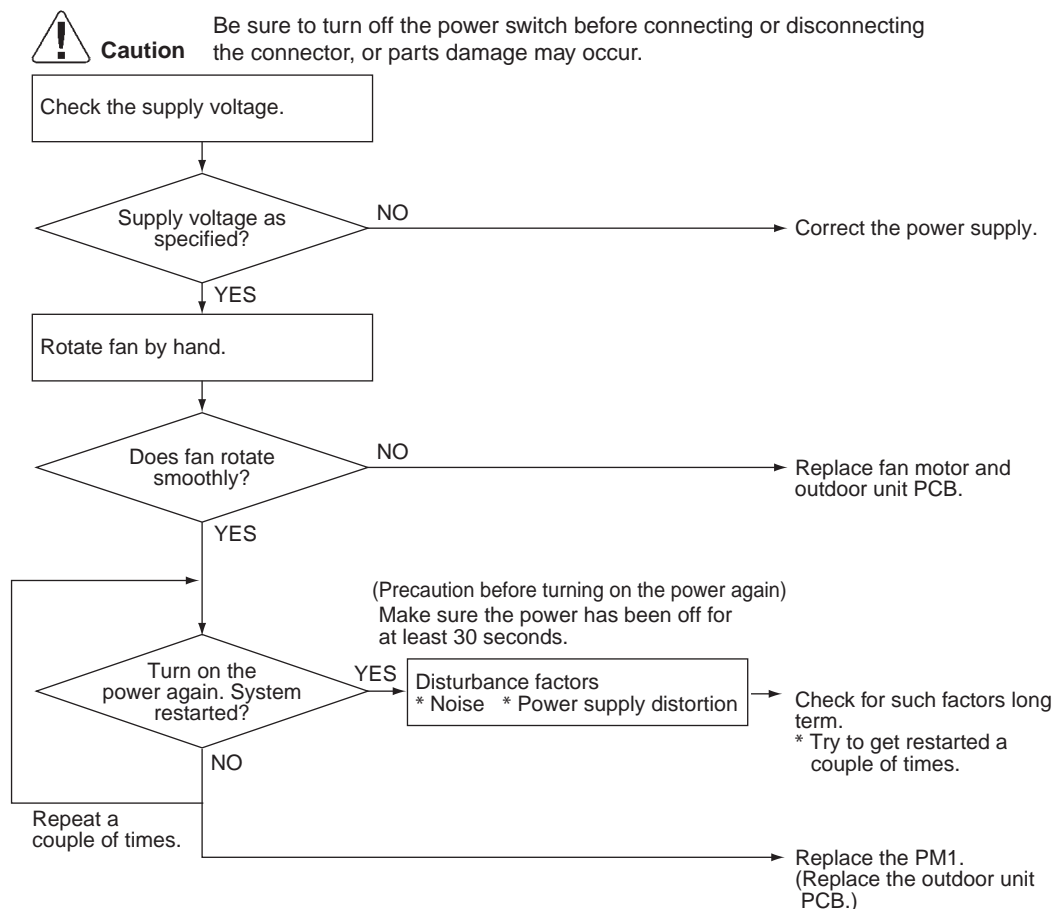

(R7179)

4.25 Signal Transmission Error on Outdoor Unit PCB

Remote
Controller
Display



Method of
Malfunction
Detection

Communication error between microcomputer mounted on the main microcomputer and PM1.

Malfunction
Decision
Conditions

- When the data sent from the PM1 can not be received successively for 9 seconds.
- The abnormality is determined if the above fault conditions occur once.
- Fault counter is reset when the data from the PM1 can be successfully received.

Supposed
Causes

- Defective outdoor unit PCB

Troubleshooting

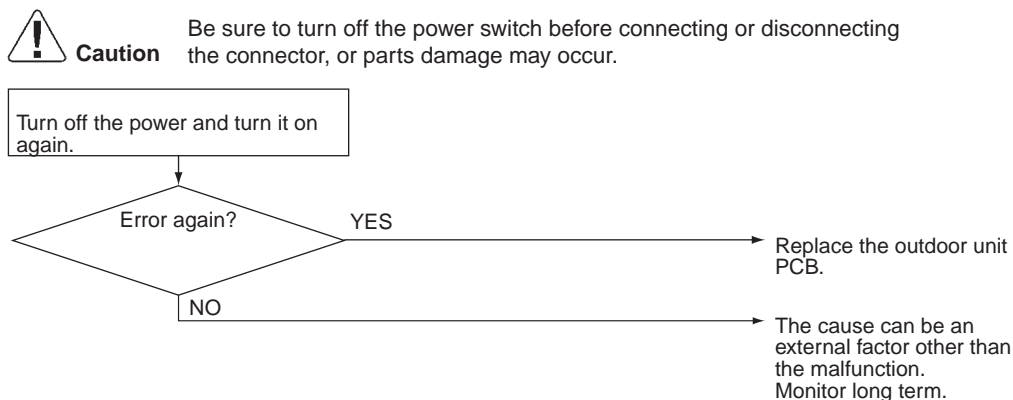

(R7185)

5. Check

5.1 How to Check

5.1.1 Fan Motor Connector Output Check

Check No.01

1. Check connector connection.
2. Check motor power supply voltage output (pins 4-7).
3. Check motor control voltage (pins 4-3).
4. Check rotation command voltage output (pins 4-2).
5. Check rotation pulse input (pins 4-1).

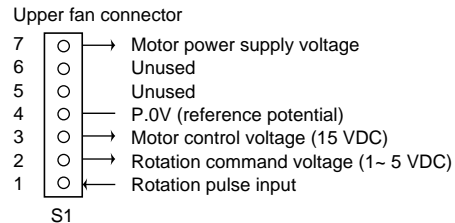

(R6940)

5.1.2 Electronic Expansion Valve Check

Check No.04

Conduct the following to check the electronic expansion valve (EV).

1. Check to see if the EV connector is correctly inserted in the PCB. Compare the EV unit and the connector number.
2. Turn the power off and back on again, and check to see if all the EVs generate latching sound.
3. If any of the EVs does not generate latching noise in the above step 2, disconnect that connector and check the conductivity using a tester.
Check the conductivity between pins 1, 2, 3, 4 and 6. If there is no conductivity between the pins, the EV coil is faulty.

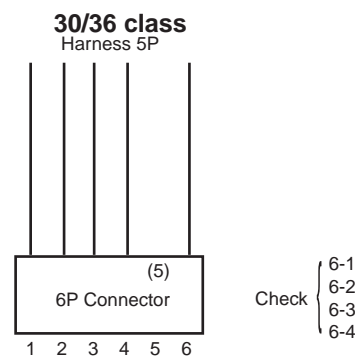

(R9746)

4. If no EV generates latching sound in the above step 2, the outdoor unit PCB is faulty.
5. If the conductivity is confirmed in the above step 3, mount a good coil (which generated latching sound) in the EV unit that did not generate latching sound, and check to see if that EV generates latching sound.
 - * If latching sound is generated, the outdoor unit PCB is faulty.
 - * If latching sound is not generated, the EV unit is faulty.



Note: Please note that the latching sound varies depending on the valve type.

5.1.3 Four-Way Valve Performance Check

Check No.05

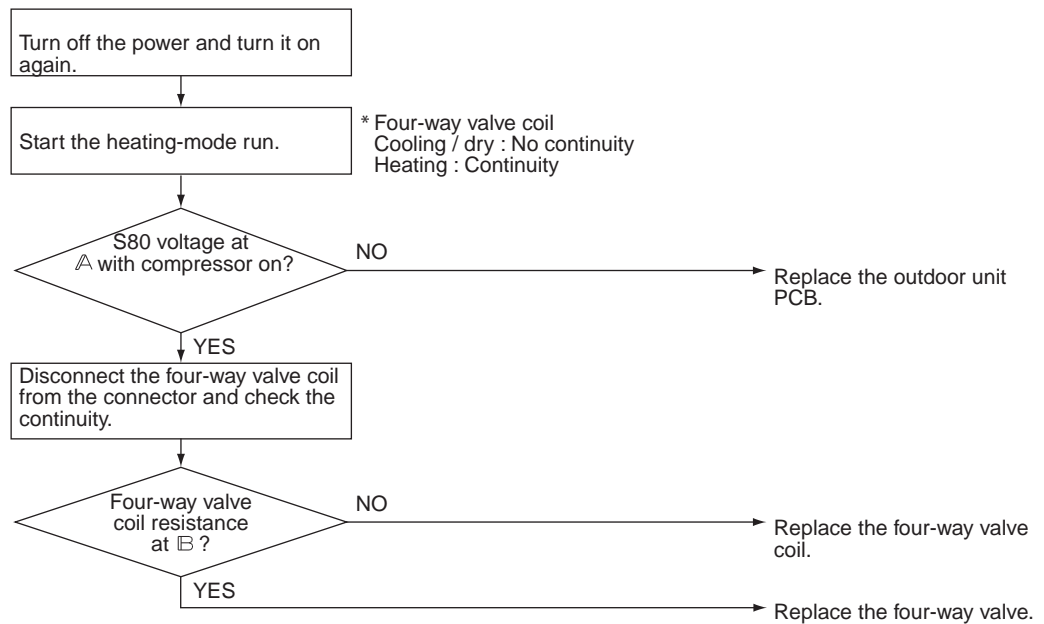

(R9319)

A	30/36 class	AC198~264V
B	30/36 class	1500 (±10%) Ω

5.1.4 Thermistor Resistance Check

Check No.06

Remove the connectors of the thermistors on the PCB, and measure the resistance of each thermistor using tester.

The relationship between normal temperature and resistance is shown in the graph and the table below.

Temperature (°C / °F)	Thermistor R25°C(77°F)=20kΩ B=3950
-20 / -4	211.0 (kΩ)
-15 / 5	150
-10 / 14	116.5
-5 / 23	88
0 / 32	67.2
5 / 41	51.9
10 / 50	40
15 / 59	31.8
20 / 68	25
25 / 77	20
30 / 86	16
35 / 95	13
40 / 104	10.6
45 / 113	8.7
50 / 122	7.2

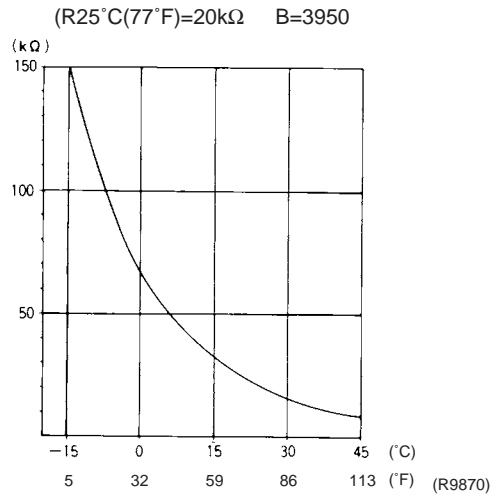
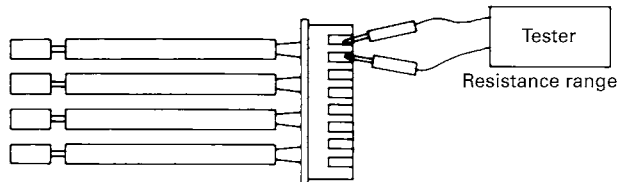

- For the models in which the thermistor is directly mounted on the PCB.

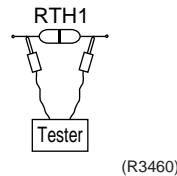

5.1.5 Installation Condition Check

Check No.07

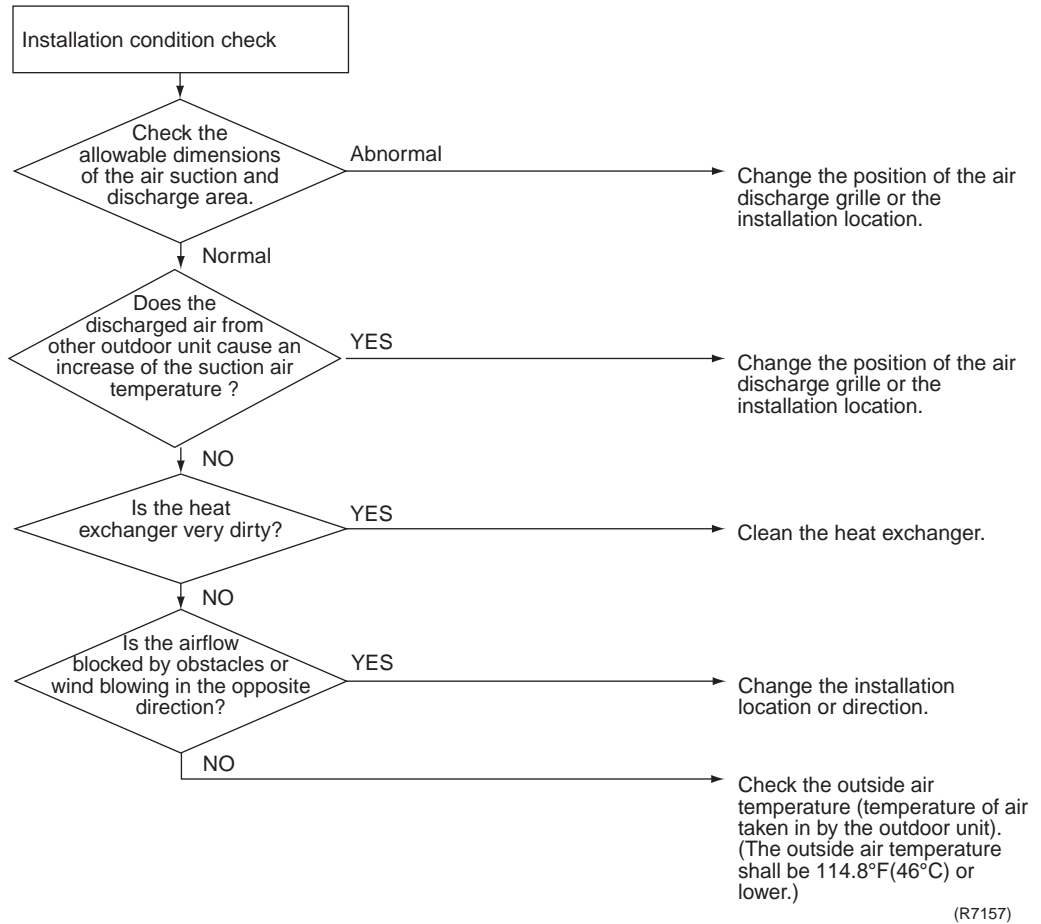

5.1.6 Discharge Pressure Check

Check No.08

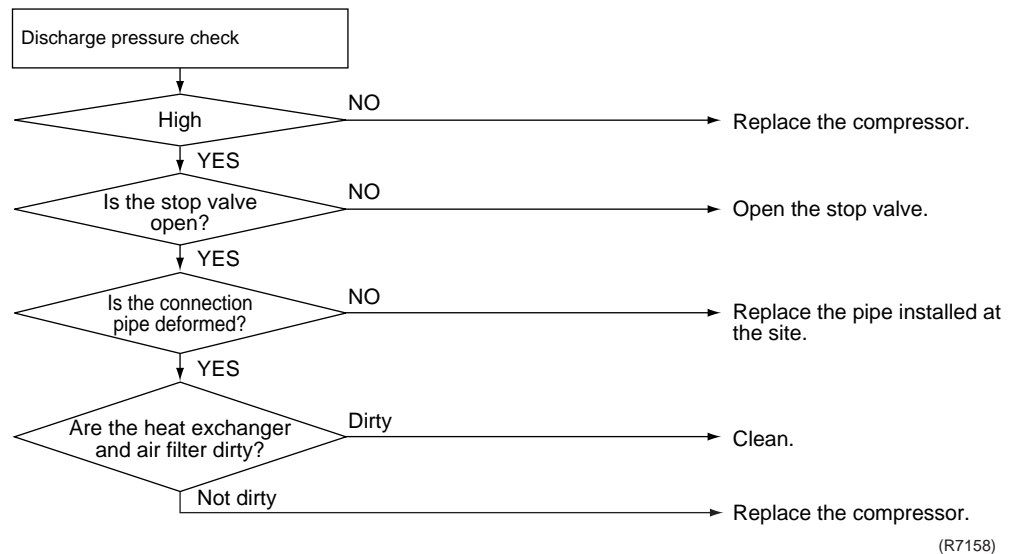

5.1.7 Outdoor Unit Fan System Check (With DC Motor)

Check No.09

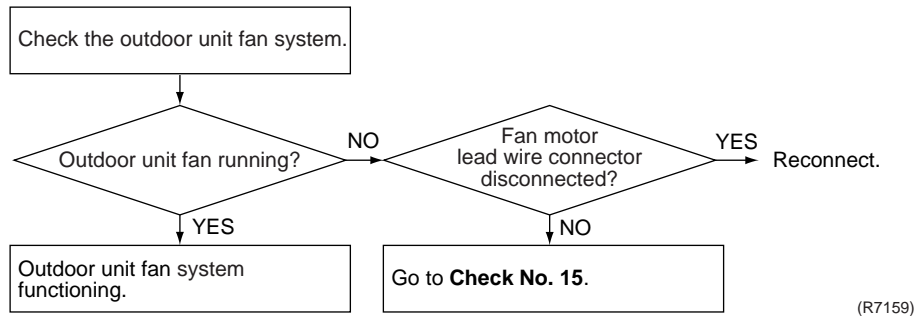

(R7159)

5.1.8 Power Supply Waveforms Check

Check No.10

Measure the power supply waveform between pins 1 and 2 on the terminal board, and check the waveform disturbance.

- Check to see if the power supply waveform is a sine wave (Fig.1).
- Check to see if there is waveform disturbance near the zero cross (sections circled in Fig.2)

[Fig.1]

[Fig.2]

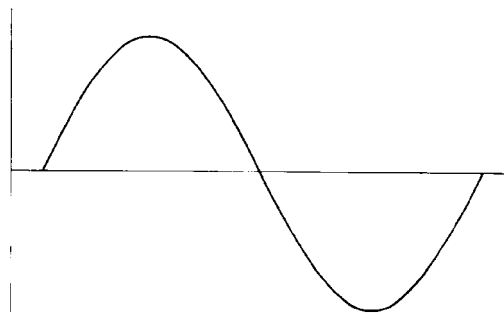

(R1736)

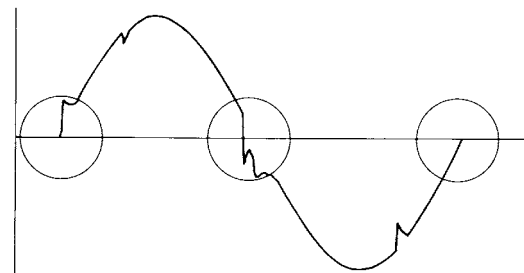

(R1444)

5.1.9 Inverter Units Refrigerant System Check

Check No.11

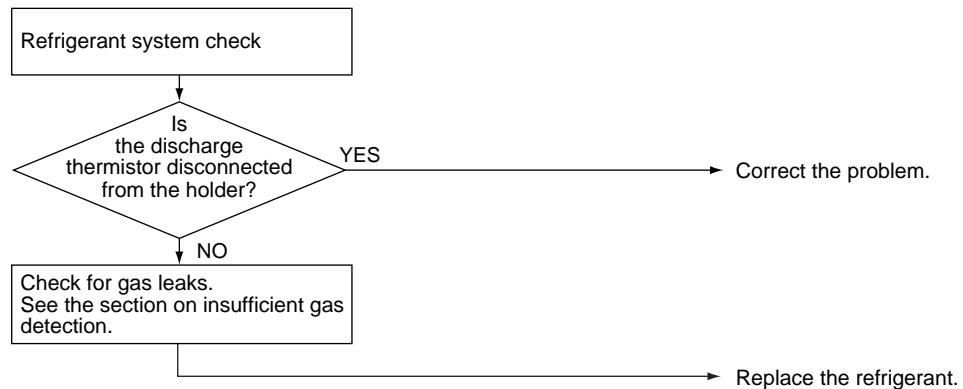

(R8314)

5.1.10 Capacitor Voltage Check

Check No.12

Before this checking, be sure to check the main circuit for short-circuit.

- Checking the capacitor voltage
- With the circuit breaker still on, measure the voltage according to the drawing of the model in question. Be careful never to touch any live parts.

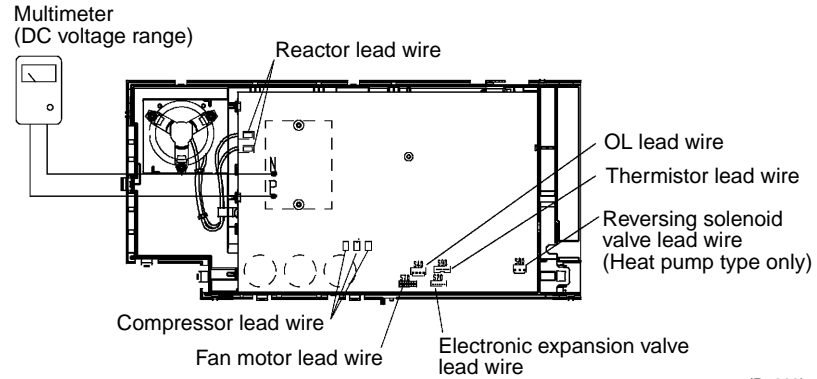

(R5222)

5.1.11 Power Transistor Check

Check No.13

- Checking the power transistor
- Never touch any live parts for at least 10 minutes after turning off the circuit breaker.
- If unavoidably necessary to touch a live part, make sure the power transistor's supply voltage is below 50 V using the tester.
- For the UVW, make measurements at the Faston terminal on the board or the relay connector.

Tester's negative terminal	Power transistor (+)	UVW	Power transistor (-)	UVW
Tester's positive terminal	UVW	Power transistor (+)	UVW	Power transistor (-)
Normal resistance	Several kΩ to several MΩ			
Abnormal resistance	0 or ∞			

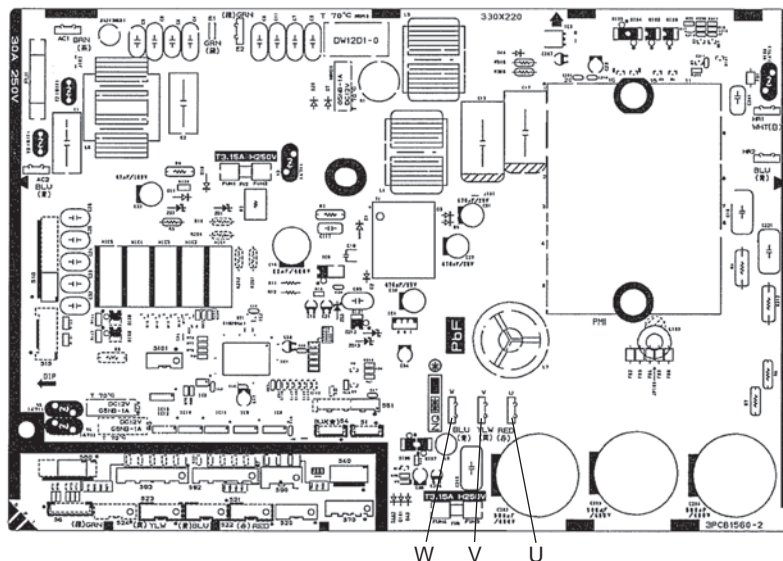

(R9747)

5.1.12 Turning Speed Pulse Input on the Outdoor Unit PCB Check

Check No.15

<Propeller fan motor>

Make sure the voltage of DC 325±50V is being applied.

- (1) Stop the operation first, turn the power off, and disconnect the connector S70.
- (2) Make sure there is about DC 325 V between pins 4 and 7.
- (3) With the system and the power still off, reconnect the connector S70.
- (4) Turn the fan motor with your hand to ensure the pulse (0-15 V) appears twice at pins 1 and 4.

If the fuse for fan motor protection has blown out, the outdoor-unit fan may also be malfunctioning. Check the fan too.

If the voltage in Step (2) is not applied, it means the PCB is defective. Replace the PCB.

If the pulse in Step (4) is not available, it means the Hall IC is defective. Replace the DC fan motor.

If neither the voltage (2) nor the pulse is available (4), replace the PCB.

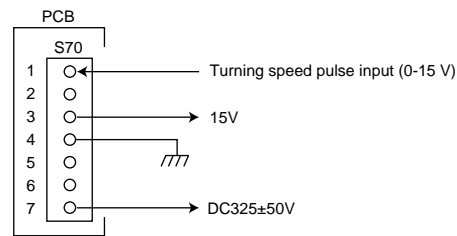

(R9297)

* Propeller fan motor : S70

Part 7

Removal Procedure

1. Indoor Unit.....	114
1.1 Removal of Air Filter / Front Panel	114
1.2 Removal of Front Grille	117
1.3 Removal of Electrical Box	120
1.4 Removal of PCB.....	127
1.5 Removal of Horizontal Blades (Louvers) / Vertical blades (Fins) / Swing Motors135	
1.6 Removal of Fan Motor.....	143
1.7 Removal of Heat Exchanger	146
1.8 Removal of Fan Rotor	150
2. Outdoor Unit.....	152
2.1 Removal of Outer Panels	152
2.2 Removal of the Electrical Box	166
2.3 Removal of PCB.....	170
2.4 Removal of Fan Motor.....	173
2.5 Removal of Coils / Thermistors	174
2.6 Removal of Sound Blanket.....	177
2.7 Removal of Compressor.....	180

1. Indoor Unit

1.1 Removal of Air Filter / Front Panel

Procedure



Warning Be sure to wait 10 minutes or more after turning off all power supplies before disassembly work.

Step	Procedure	Points
<p>1. External appearance</p>		<ul style="list-style-type: none"> ■ When the signal receiver catches a signal from the remote controller, it produces beep sound and the operation lamp blinks.
<p>2. Removal of the air filters.</p>	<p>1 Hold the front panel by the tabs on the both sides and lift it until it stops with a click.</p> <p>2 Lift an air filter upwards slightly by the center knob, and then pull it out downwards.</p>	<ul style="list-style-type: none"> ■ The 3 filters are interchangeable. ■ Set the air filters with displaying "FRONT" on the front side. ■ Set the air filters on the hooks of the front grille ASSY.

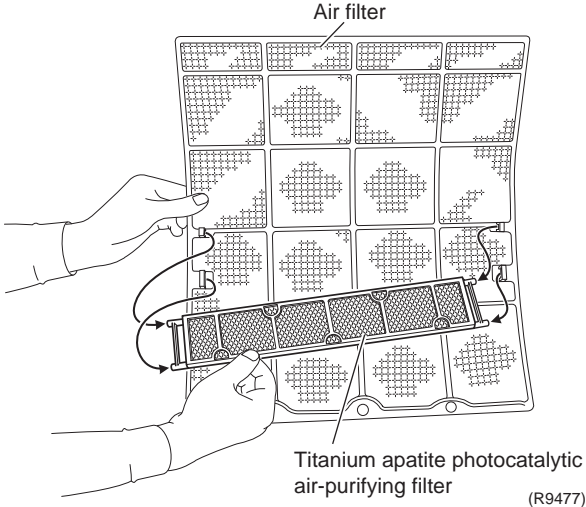
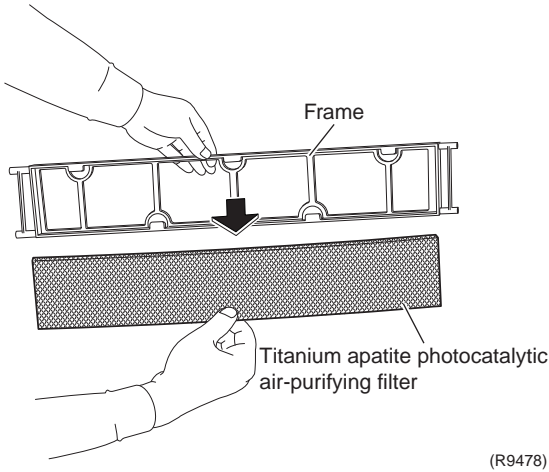
Step	Procedure	Points
3.	Removal of the Titanium apatite photocatalytic air-purifying filter.	
1	<p>Remove the Titanium apatite photocatalytic air-purifying filter frame by unfastening the projections from the back of the air filter frame.</p> 	<ul style="list-style-type: none"> ■ The 3 filters are interchangeable.
2	<p>Remove the Titanium apatite photocatalytic air-purifying filter from its frame.</p> 	

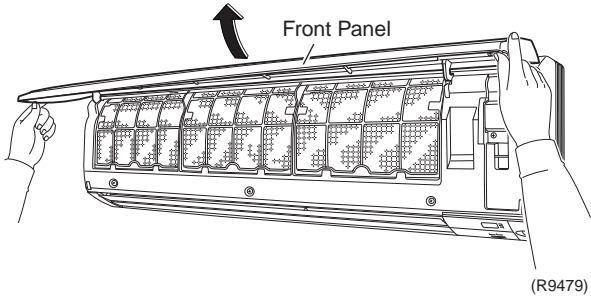
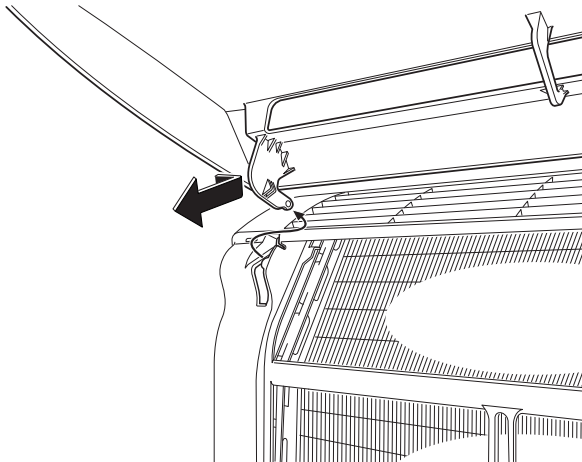
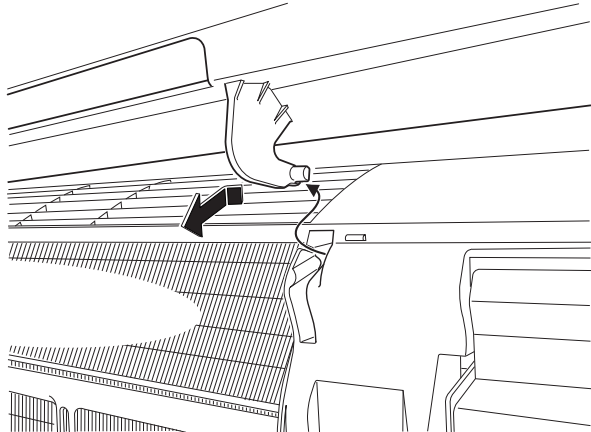
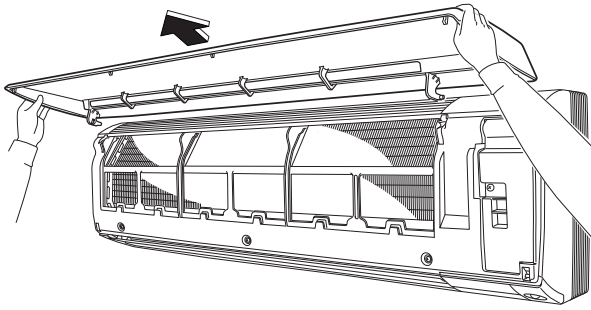
Step	Procedure	Points
<p>4. Removal of the front panel.</p> <p>1</p>	<p>While opening the front panel further than it stops, release both axes and remove the front panel.</p>  <p>(R9479)</p>  <p>(R9480)</p>  <p>(R9481)</p>	<ul style="list-style-type: none"> ■ Slide the front panel side to side to release each axis. ■ Align the right and left axes with grooves in turn and insert them to the end when installing.
<p>2</p>	<p>Remove the front panel.</p>  <p>(R9482)</p>	

1.2 Removal of Front Grille

Procedure



Warning

Be sure to wait 10 minutes or more after turning off all power supplies before disassembly work.

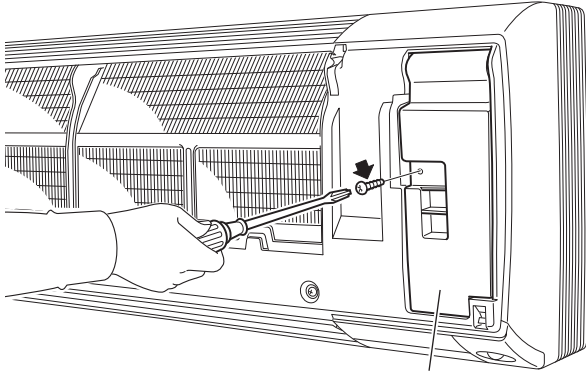
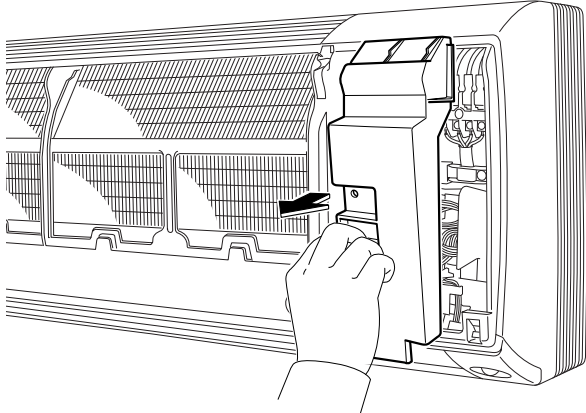
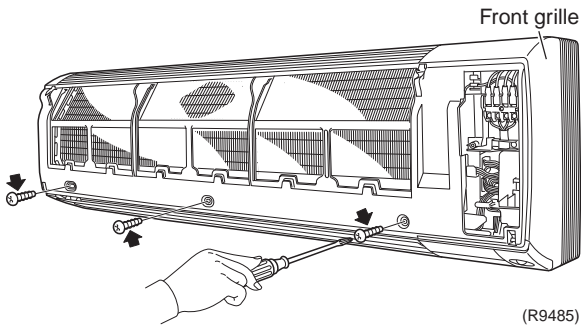
Step	Procedure	Points
<p>1. Removal of the service cover.</p> <p>1 Remove the screw and remove the service cover.</p>	 <p style="text-align: right;">Service cover (R9483)</p>  <p style="text-align: right;">(R9484)</p>	<ul style="list-style-type: none"> ■ No field setting switch is inside it. ■ You can remove the front grille without detaching the service cover.
<p>2. Removal of the front grille.</p> <p>1 Remove the 3 fixing screws of the front grille.</p>	 <p style="text-align: right;">Front grille</p> <p style="text-align: right;">(R9485)</p>	

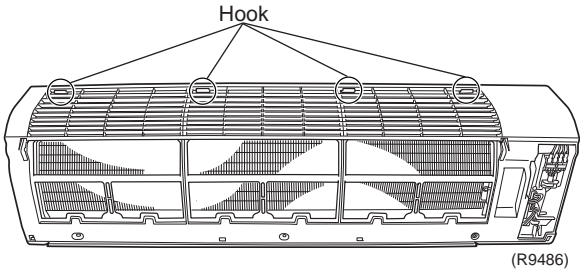
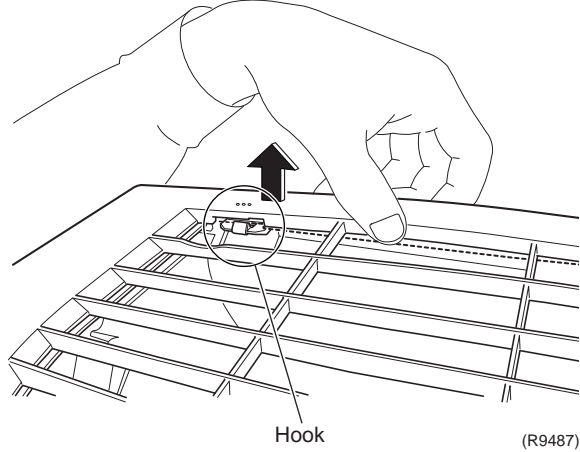
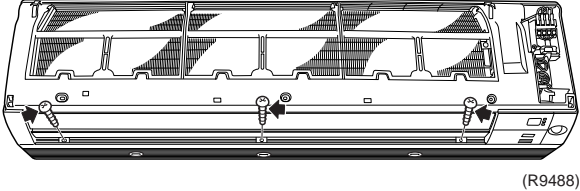
Step	Procedure	Points
2	<p data-bbox="199 212 472 275">Release the 4 hooks on the top of the front grille.</p>  	<ul style="list-style-type: none"> <li data-bbox="1114 212 1484 306">■ Refer to the removal procedure in a reverse way when reassembling.
3	<p data-bbox="199 974 423 1037">Remove the 3 fixing screws.</p> 	

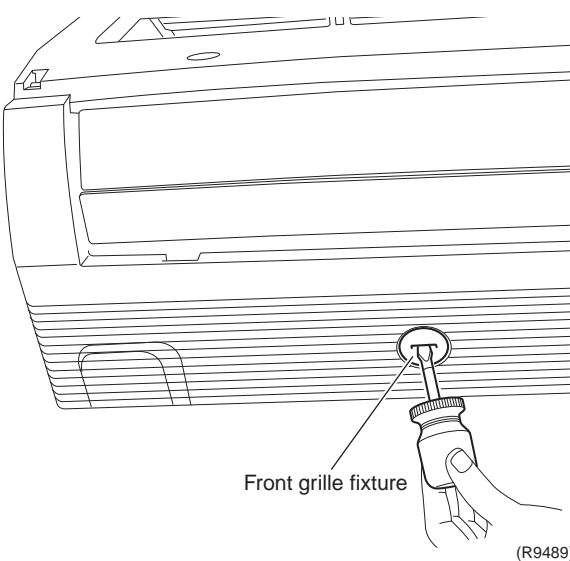
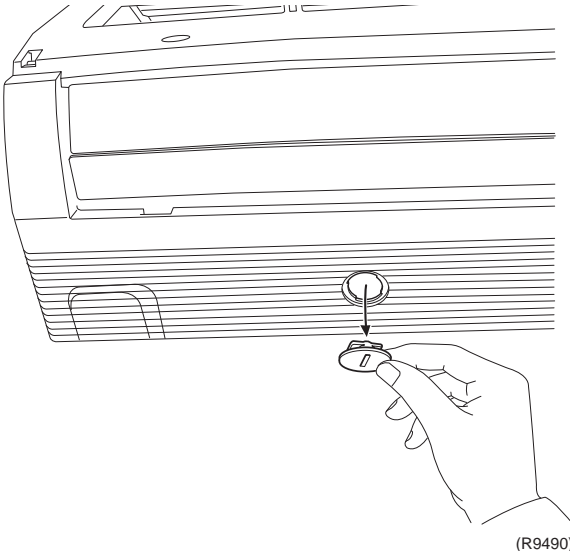
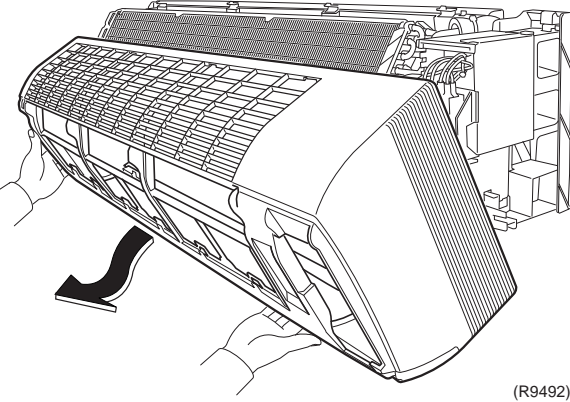
Step		Procedure	Points
4	Remove the 3 front grille fixtures.	 <p>Front grille fixture</p> <p>(R9489)</p>  <p>(R9490)</p>	<ul style="list-style-type: none"> ■ The illustration shows the left fixture.
5	Pull the upper part of the front grille out and lift the lower part up, and then remove the front grille.	 <p>(R9492)</p>	<ul style="list-style-type: none"> ■ Make sure that all the hooks are placed securely when reassembling.

1.3 Removal of Electrical Box

Procedure



Warning

Be sure to wait 10 minutes or more after turning off all power supplies before disassembly work.

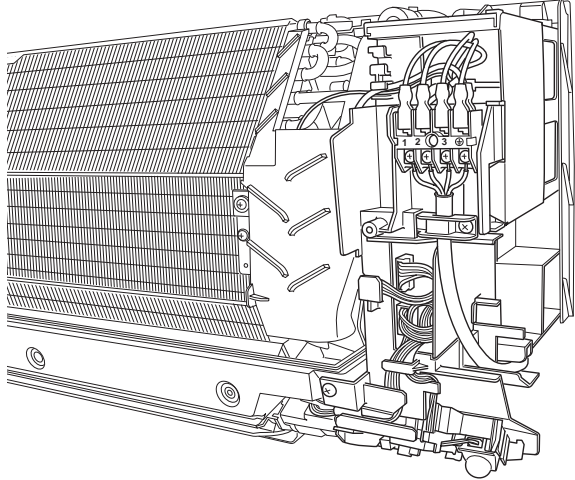
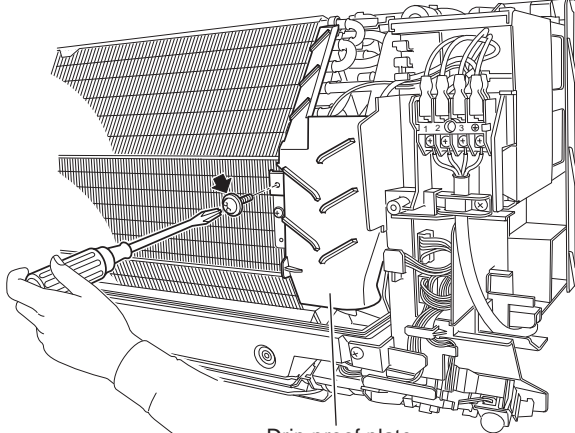
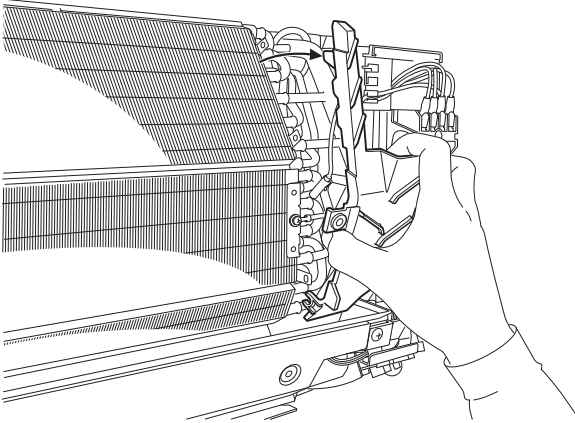
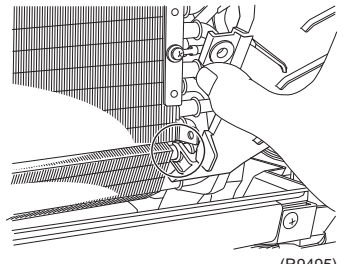
Step	Procedure	Points
1. Removal of the front grille.	<p>Parts layout</p>  <p style="text-align: right;">(R9493)</p>	<p>■ Parts layout</p>
2. Removal of the drip proof plate.	<p>1 Remove the screw.</p>  <p style="text-align: center;">Drip proof plate (R9494)</p> <p>2 Remove the drip proof plate from the heat exchanger.</p>  <p style="text-align: right;">(R9496)</p>	 <p style="text-align: right;">(R9495)</p> <p>■ When reassembling, fit the hole to the heat exchanger.</p>

Step	Procedure	Points
3.	Disconnect the indoor heat exchanger thermistor and the ground.	
1	Remove the screw and release the ground.	
2	Pull out the indoor heat exchanger thermistor.	<ul style="list-style-type: none"> ■ Be careful not to lose the clip for the thermistor.

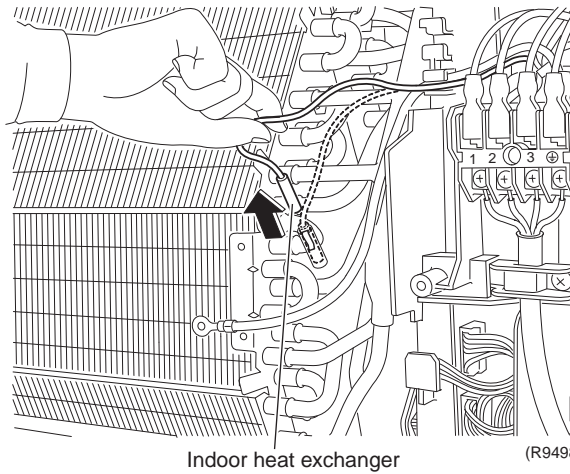
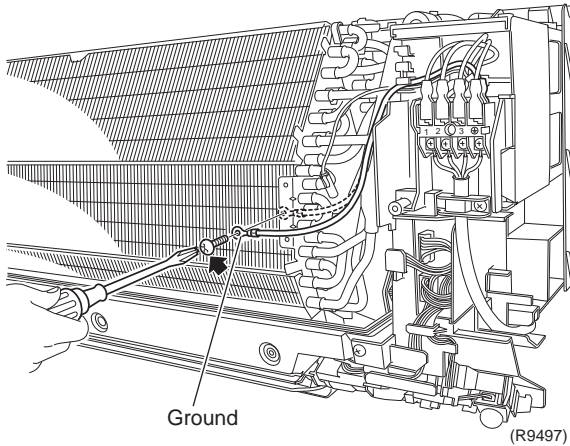

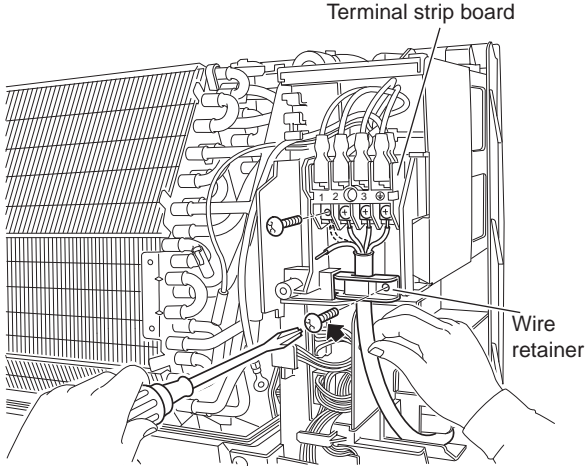
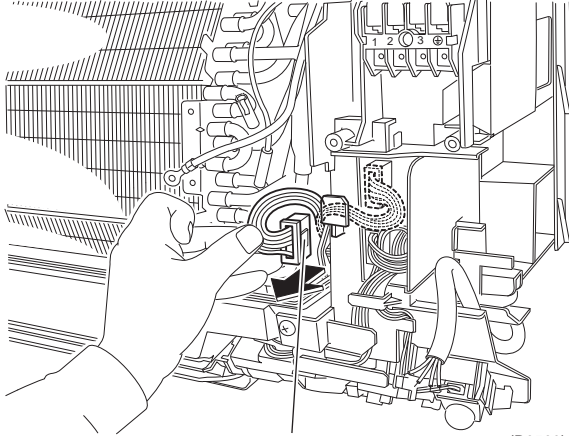
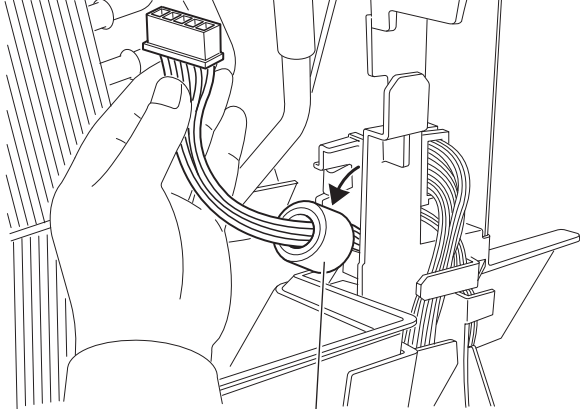
Step	Procedure	Points
4. Removal of the electrical box.		<ul style="list-style-type: none"> ■ You can remove the electrical box without detaching the terminal strip board.
1	<p>Disconnect the 4 connection wirings. Remove the screw and remove the wire retainer.</p>  <p style="text-align: right;">(R9499)</p>	
2	<p>Disconnect the connector for fan motor [S1] and release the harness from the hook.</p>  <p style="text-align: right;">(R9500)</p>	
3	<p>Release the ferrite core.</p>  <p style="text-align: right;">(R9501)</p>	

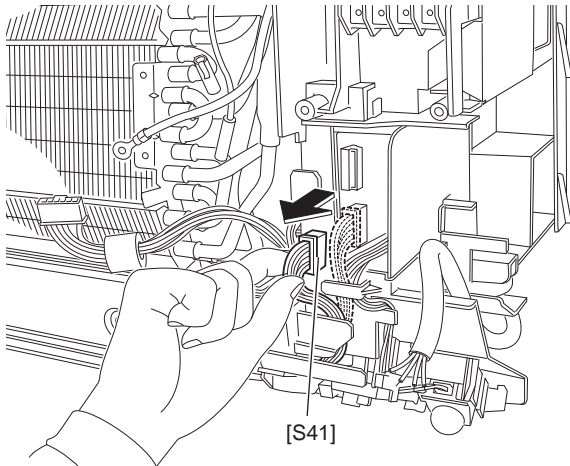
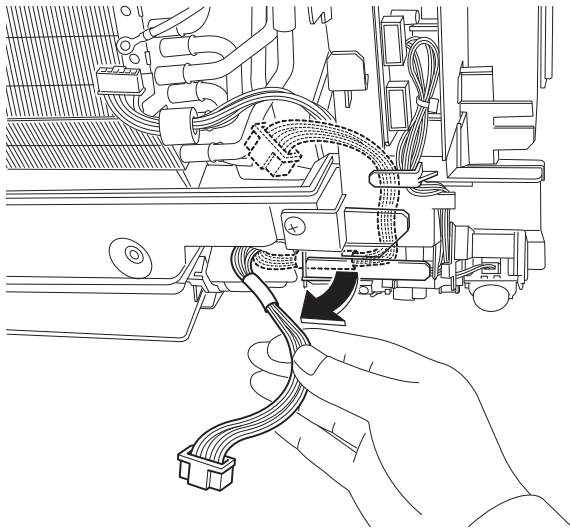
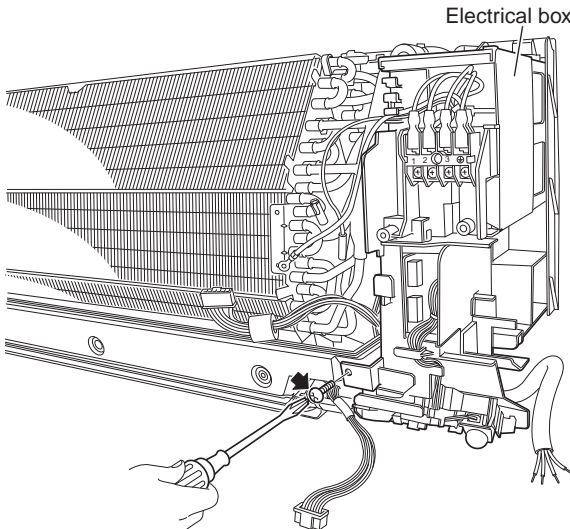
Step	Procedure	Points
4	<p>Disconnect the connector for swing motor [S41].</p>	 <p>[S41]</p> <p>(R9502)</p>
5	<p>Release the harness from the hooks.</p>	 <p>(R9503)</p>
6	<p>Release the fixing screw of the electrical box.</p>	 <p>Electrical box</p> <p>(R9504)</p>

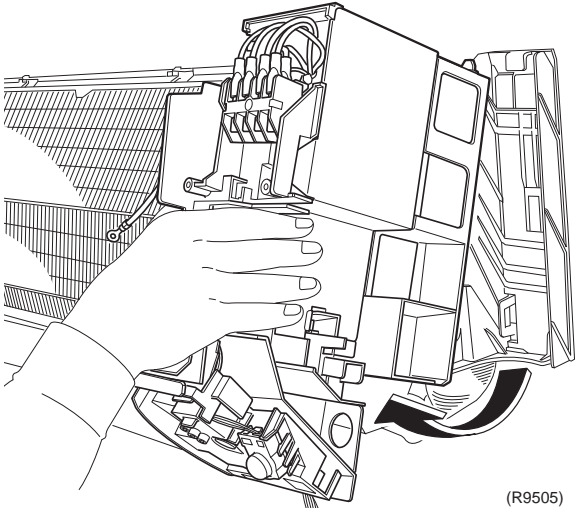
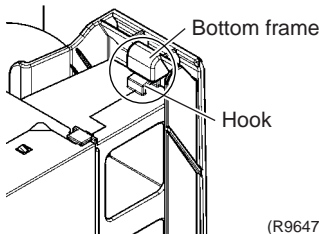
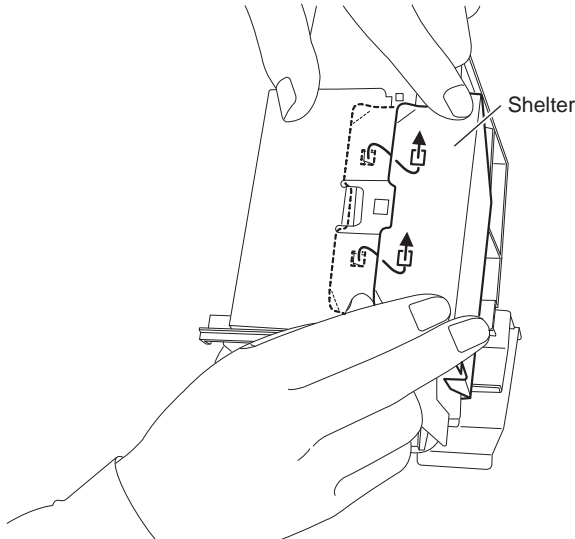
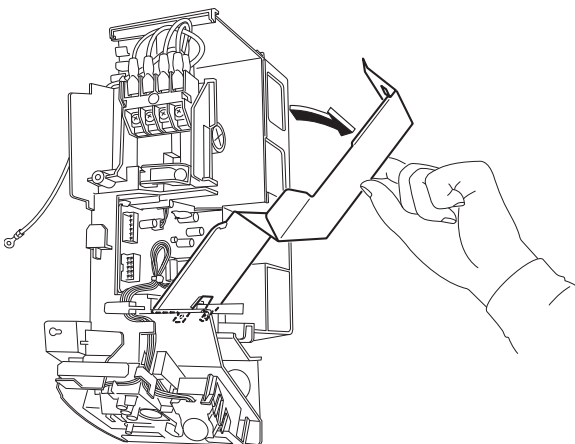
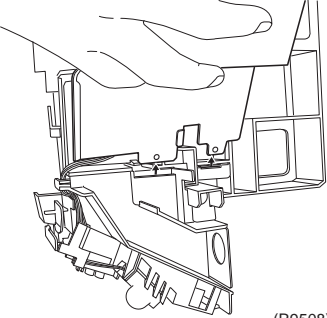
Step		Procedure	Points
7	Lift up the electrical box from the bottom to remove.	 <p>(R9505)</p>	<ul style="list-style-type: none"> Fit the back hook of the electrical box to the bottom frame when reassembling.  <p>(R9647)</p>
8	Push the shelter up and undo the hooks.	 <p>(R9506)</p>	
9	Open the shelter.	 <p>(R9507)</p>	<ul style="list-style-type: none"> The shelter has the 2 hooks at the lower part.  <p>(R9508)</p>

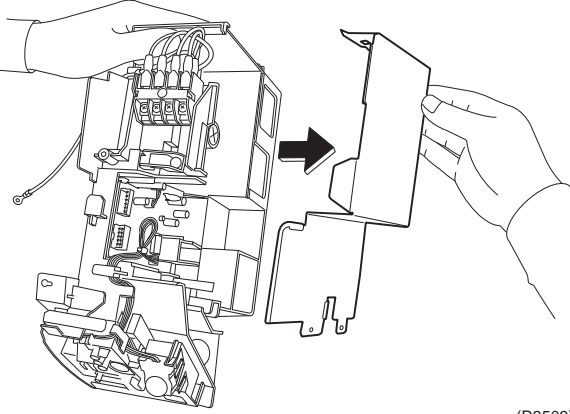
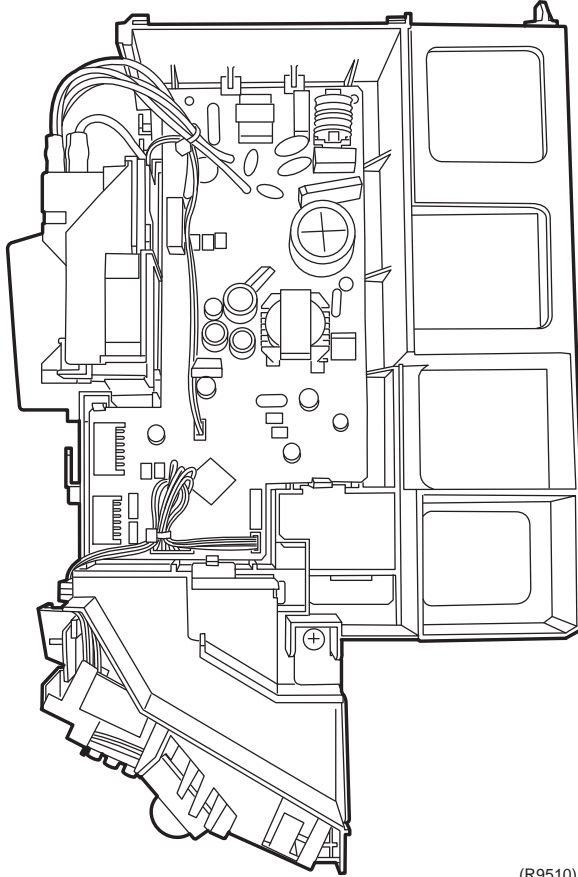
Step		Procedure	Points
10	Remove the shelter.	 <p>(R9509)</p>	
11	Internal layout.	 <p>(R9510)</p>	

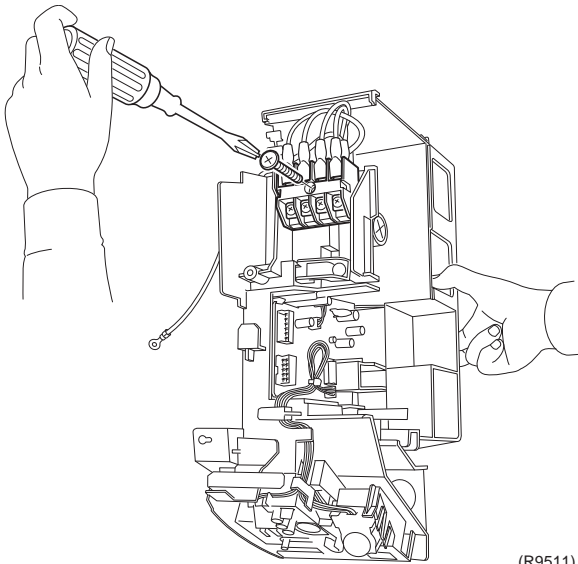
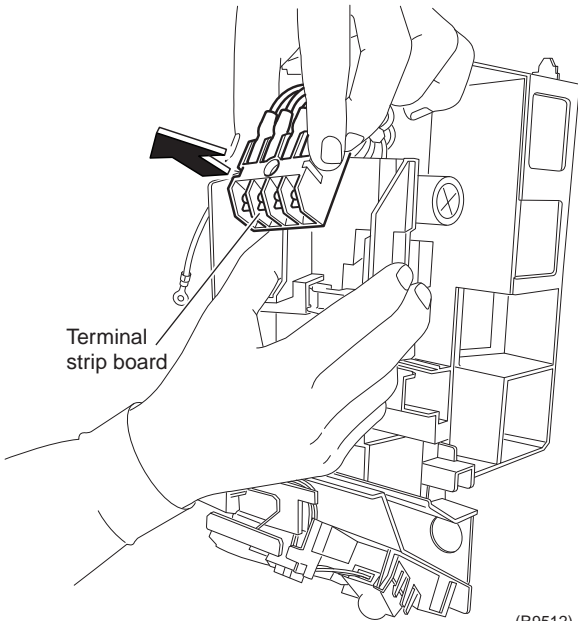
Step	Procedure	Procedure	Points
12	Remove the screw of the terminal strip board.	 <p>(R9511)</p>	
13	Remove the terminal strip board. (1 hook at the back)	 <p>Terminal strip board</p> <p>(R9512)</p>	

1.4 Removal of PCB

Procedure



Warning

Be sure to wait 10 minutes or more after turning off all power supplies before disassembly work.

Step	Procedure	Points
1.	1. Remove the control PCB.	
1	Cut the clamp.	
2	Release the harness from the hook.	<ul style="list-style-type: none"> ■ When reassembling, make sure to hook the wiring.
3	Push and release the hook.	

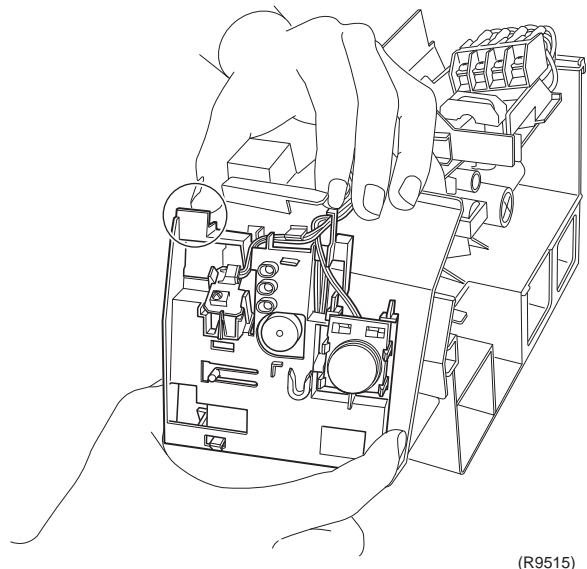
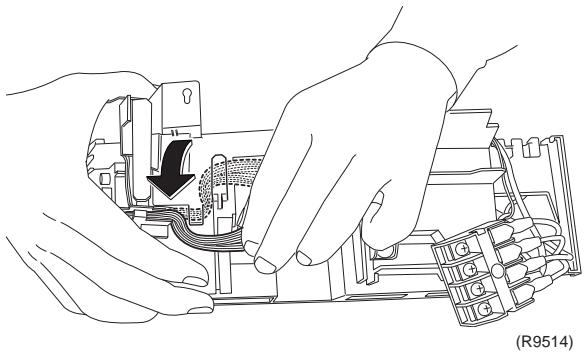
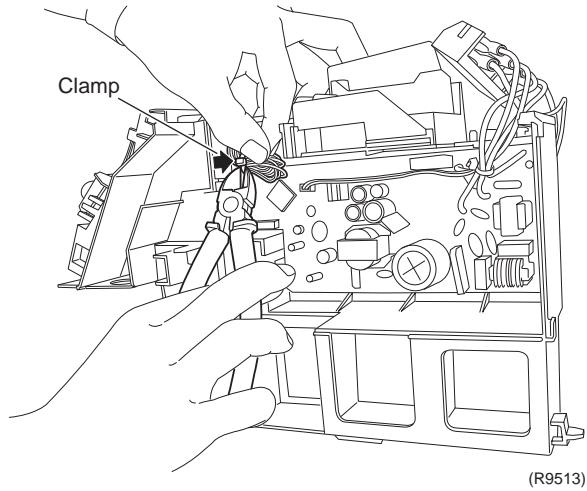

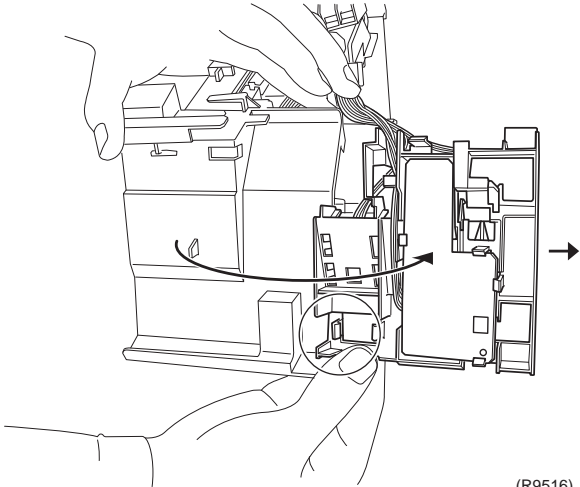
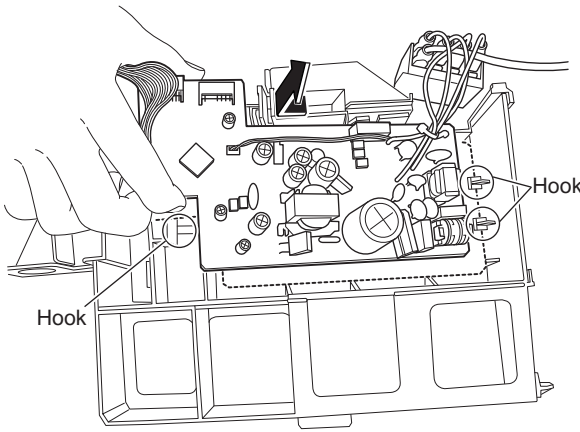
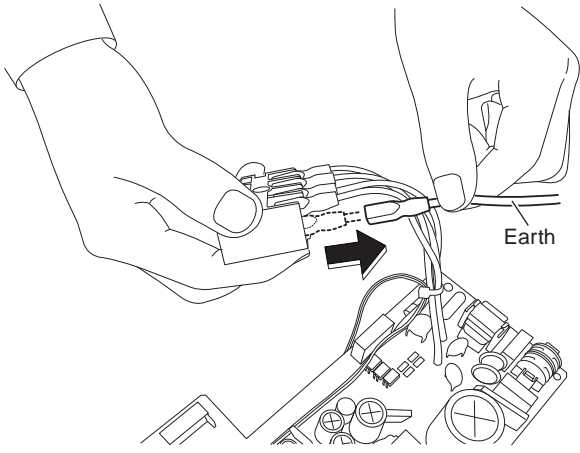
Step	Procedure	Procedure	Points
4	Open the receiver unit. Remove the receiver unit by releasing the hook.	 <p>(R9516)</p>	
5	Release the 3 hooks. Lift up and remove the control PCB.	 <p>(R9517)</p>	
6	Pull out the ground wire.	 <p>(R9518)</p>	

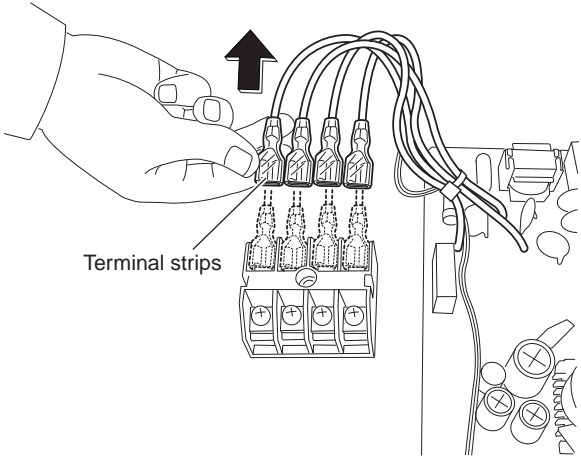
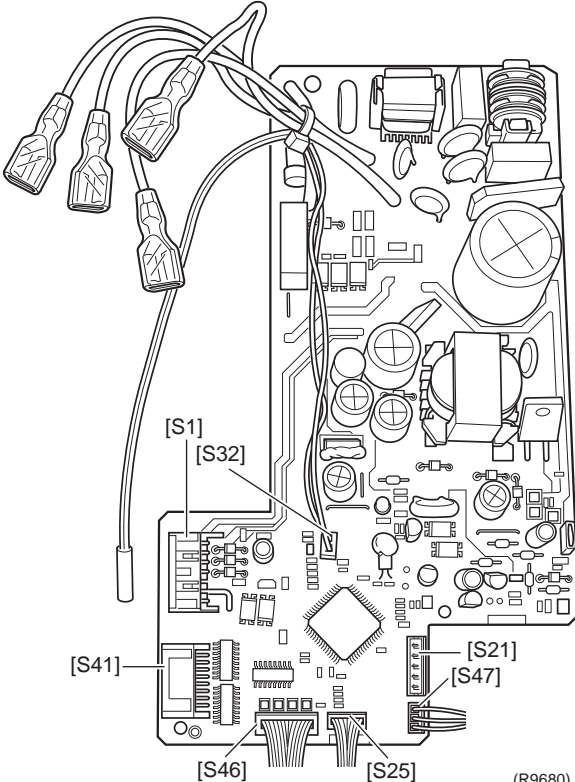
Step		Procedure	Points
7	Pull out the terminal strips.	 <p>(R9519)</p>	
8	<p>Control PCB</p> <p>[S1] To DC fan motor [S21] To centralized control (HA) [S25] To INTELLIGENT EYE [S41] To swing motor [S46] To display PCB [S47] To signal receiver PCB</p>	 <p>(R9680)</p>	<p>■ Refer to P.8 for detail.</p>

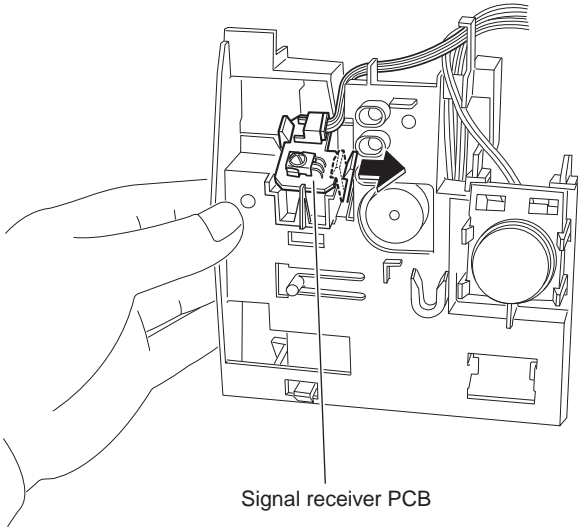
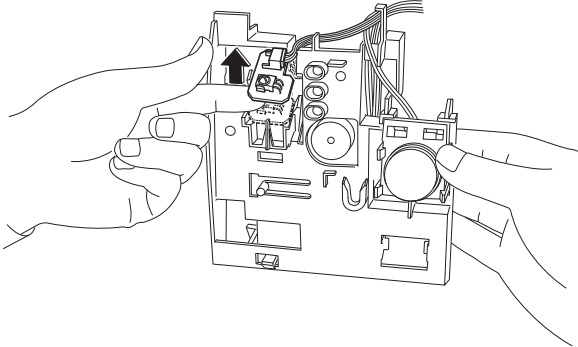
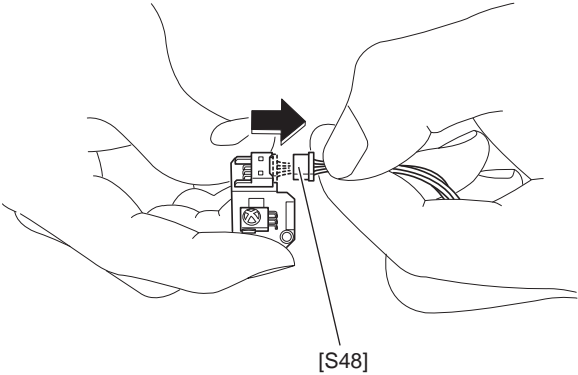
Step	Procedure	Points
2. Removal of the signal receiver PCB		
1 Release the hook on the right. (The signal receiver PCB will be lifted up.)	 <p style="text-align: center;">Signal receiver PCB</p> <p style="text-align: right;">(R9520)</p>	
2 Remove the signal receiver PCB.	 <p style="text-align: right;">(R9521)</p>	<p>■ Remove the signal receiver PCB as the upper hook centers.</p>
3 Disconnect the connector : To control PCB.	 <p style="text-align: center;">[S48]</p> <p style="text-align: right;">(R9522)</p>	

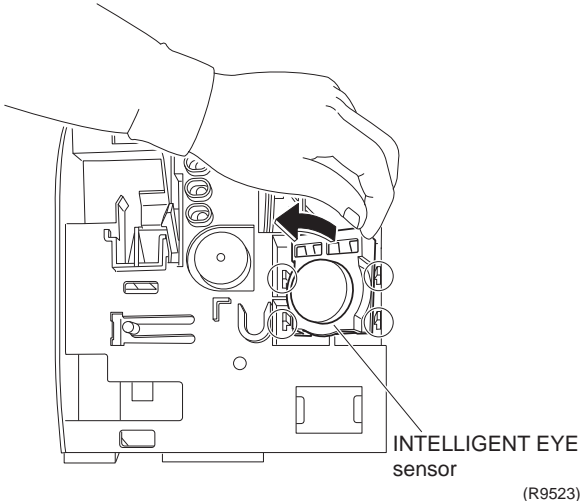
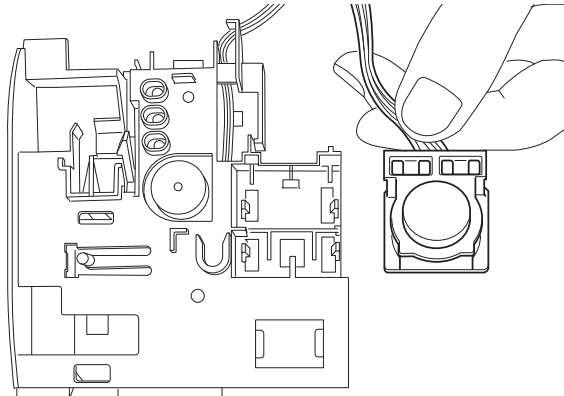
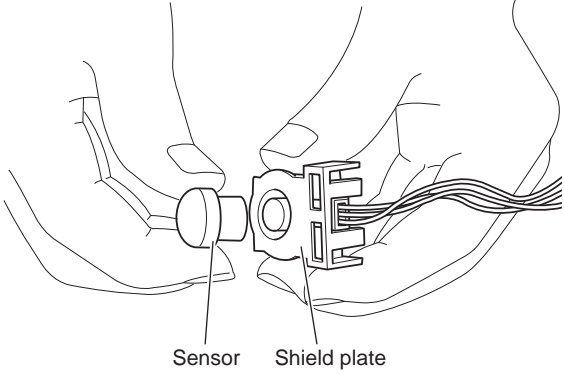
Step	Procedure	Points
3. Removal of the INTELLIGENT EYE sensor.		
1	<p>Release the 2 hooks on the right. Remove the INTELLIGENT EYE sensor as the 2 hooks on the left come center.</p>  	
2	<p>Remove the sensor from the shield plate.</p> 	<ul style="list-style-type: none"> When reassembling, set the sensor at the position where it "clicks". Otherwise, the sensor is not completely set.

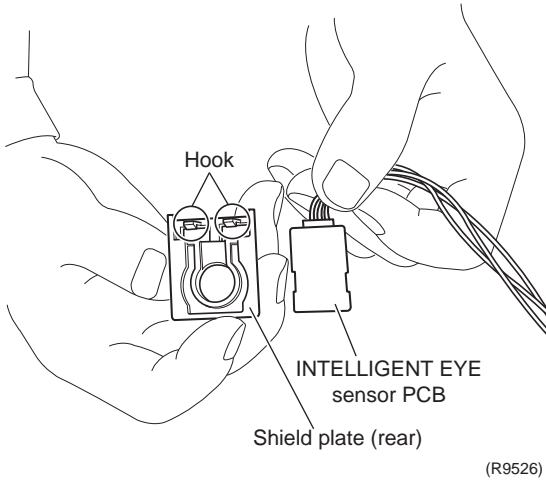
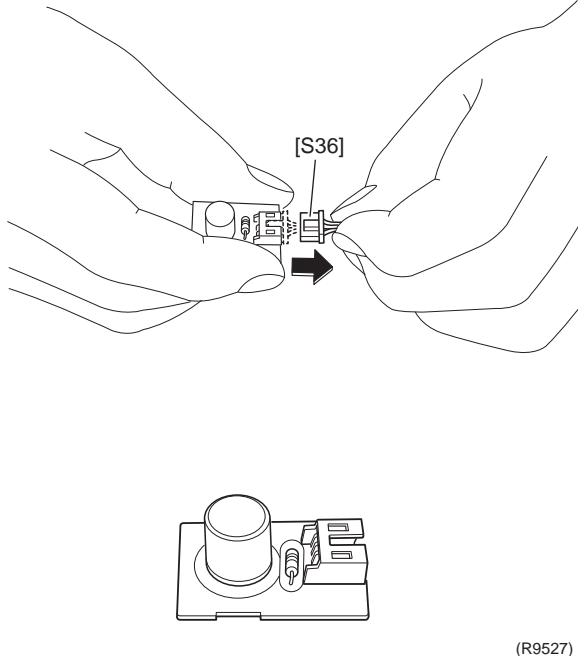
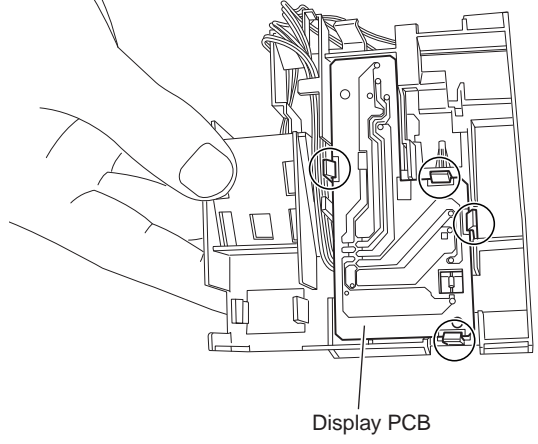
Step		Procedure	Points
3	Remove the shield plate (rear) by releasing the 2 hooks.	 <p>(R9526)</p>	
4	Disconnect the connector [S36].	 <p>(R9527)</p>	
4. Removal of the display PCB			
1	Release the 4 hooks.	 <p>(R9528)</p>	

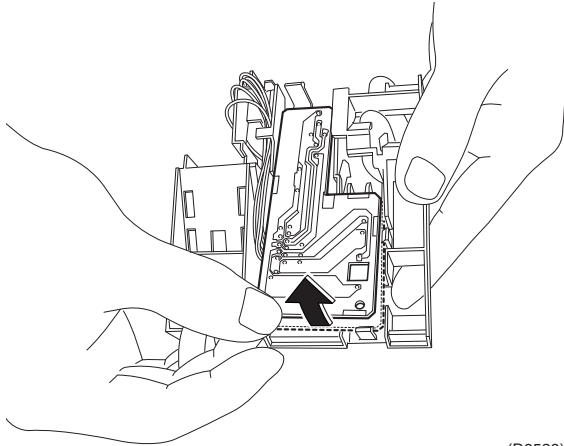
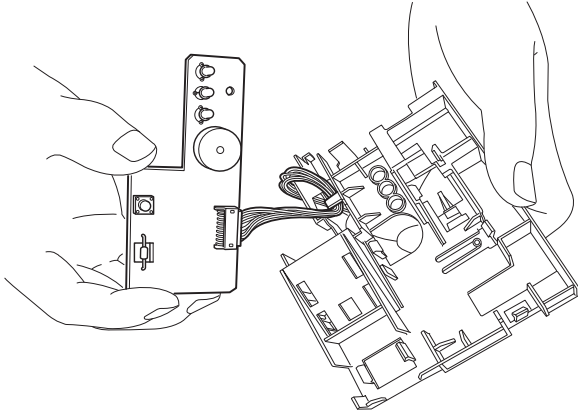
Step		Procedure	Points
2	Lift up the display PCB.	 <p>(R9529)</p>	
3	Release the harness.	 <p>(R9530)</p>	

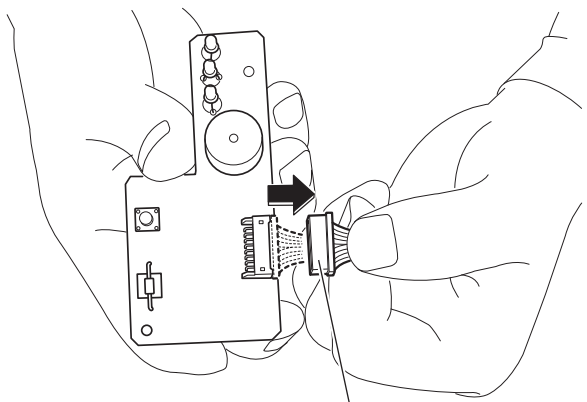
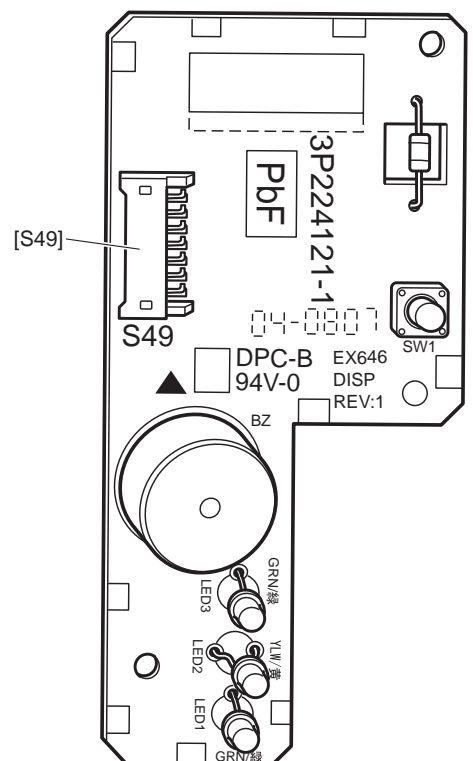
Step	Procedure	Points
<p>4</p>	<p>Disconnect the connector. [S49] : To control PCB</p>	<div style="text-align: center;">  <p>[S49] (R9531)</p> </div> <div style="text-align: center;">  <p>[S49] (R9532)</p> </div>

1.5 Removal of Horizontal Blades (Louvers) / Vertical blades (Fins) / Swing Motors

Procedure



Warning

Be sure to wait 10 minutes or more after turning off all power supplies before disassembly work.

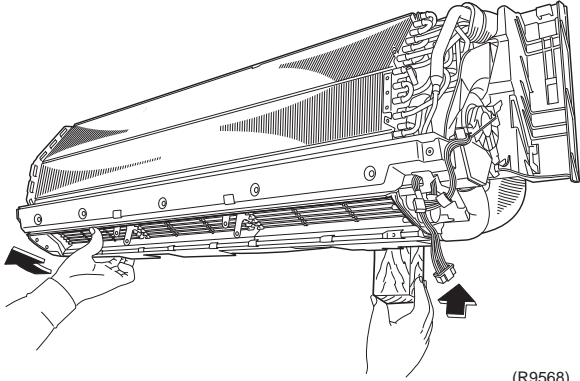
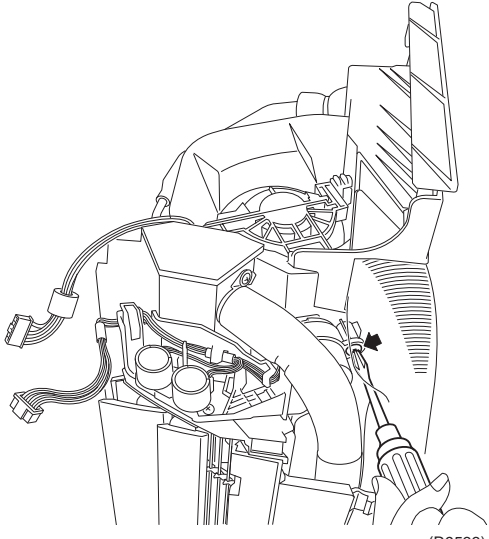
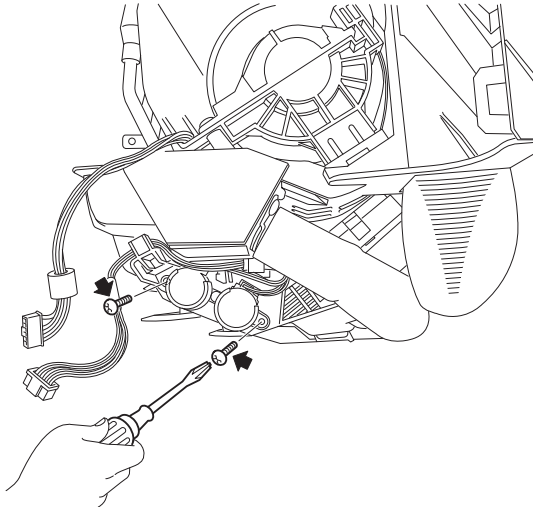
Step	Procedure	Points
1. Removal of the horizontal blades.		
1	Hold the indoor unit up by a piece of wood etc.  <p style="text-align: right;">(R9568)</p>	
2	Remove the screw at the rear of the indoor unit.  <p style="text-align: right;">(R9533)</p>	
3	Remove the 2 screws (front and rear).  <p style="text-align: right;">(R9534)</p>	

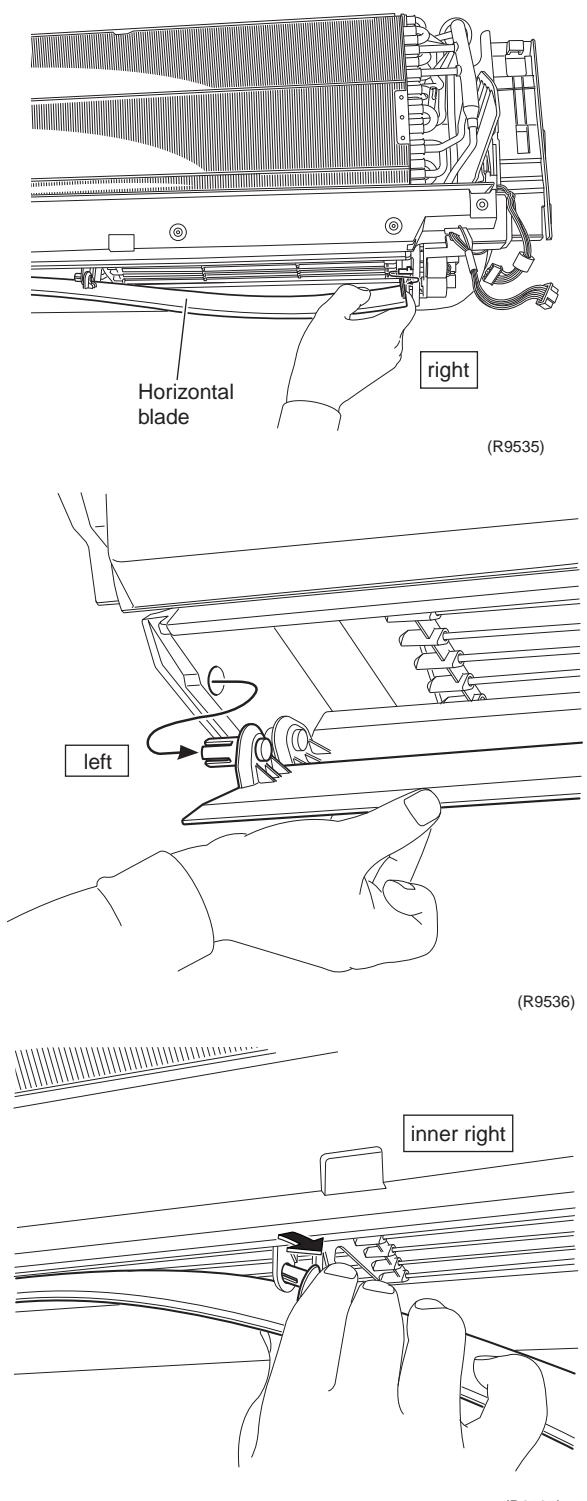
Step		Procedure	Points
4	Remove the horizontal blades by releasing the hook and the protrusions.	 <p>Horizontal blade</p> <p>right</p> <p>(R9535)</p> <p>left</p> <p>(R9536)</p> <p>inner right</p> <p>(R9537)</p>	<ul style="list-style-type: none">■ Removing order (Right hook → left protrusion → inner-right protrusion → inner-left protrusion)

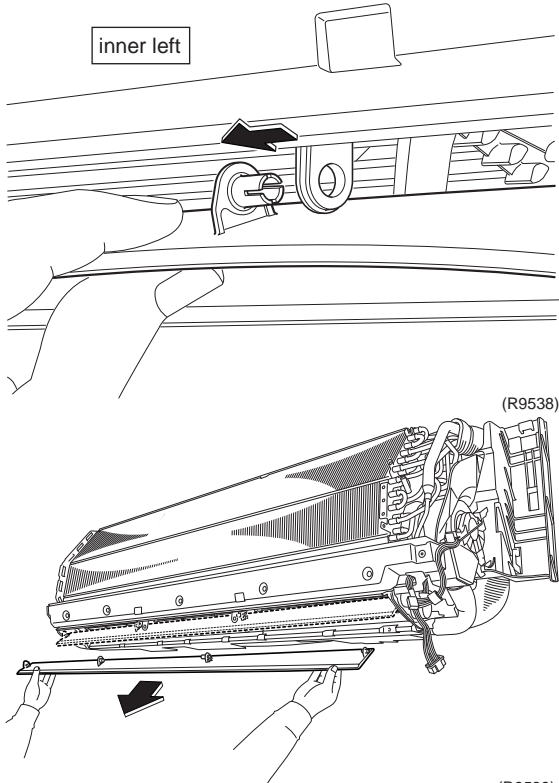
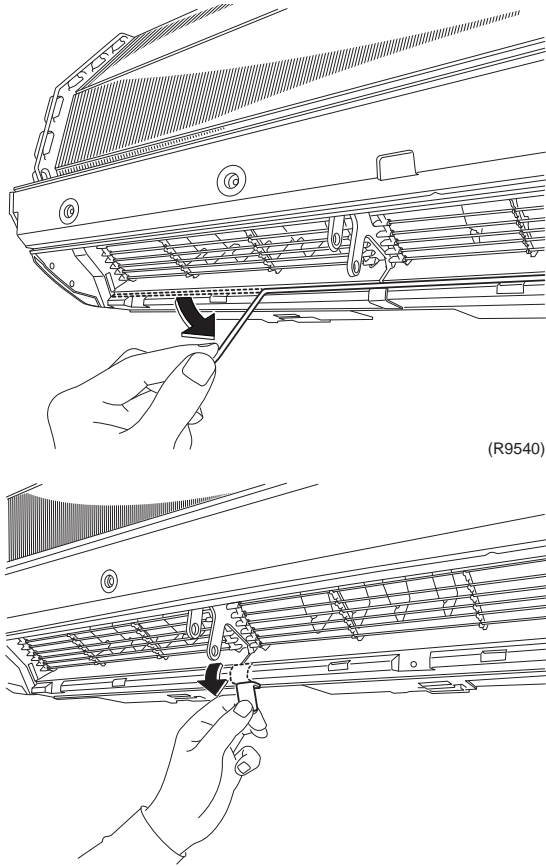
Step		Procedure	Points
			
2.	<p>Removal of the fan guards.</p> <p>1 Remove the sealing material (horizontal).</p> <p>2 Remove the sealing material (vertical, 2 position).</p>		

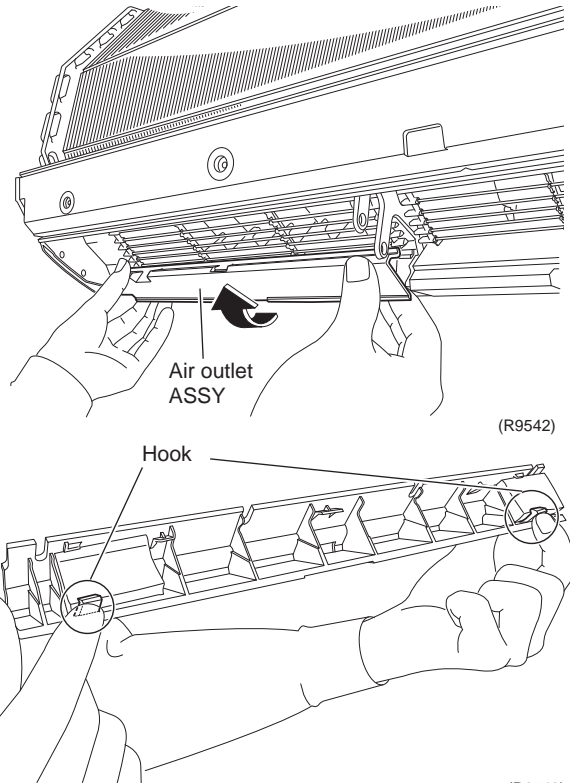
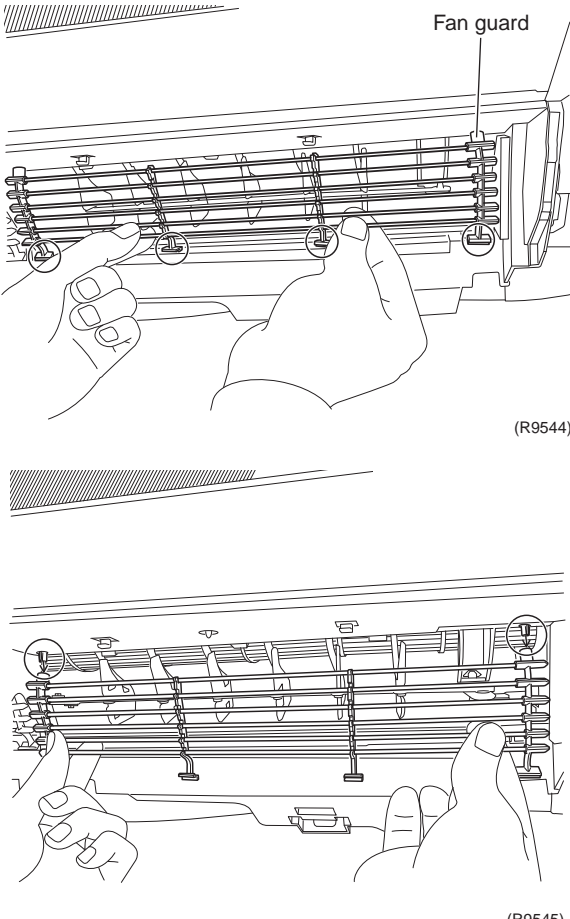
Step	Procedure	Procedure	Points
3	Remove the left air outlet assembly by pushing the 2 hooks at the back.	 <p>Air outlet ASSY (R9542)</p> <p>Hook (R9543)</p>	■ Remove the center and right air outlet assembly likewise.
4	Remove the fan guards by releasing the 4 lower hooks and the 2 upper protrusions.	 <p>Fan guard (R9544)</p> <p>(R9545)</p>	

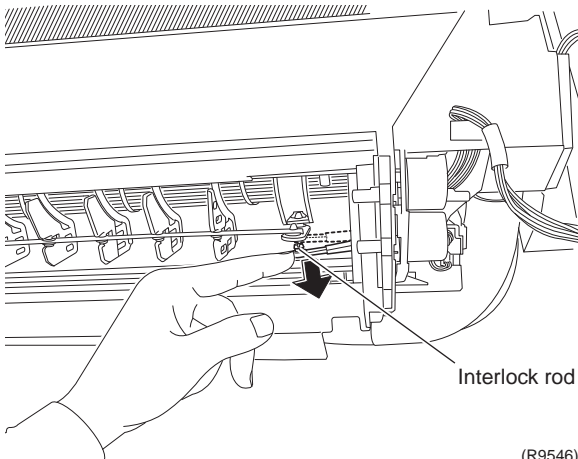
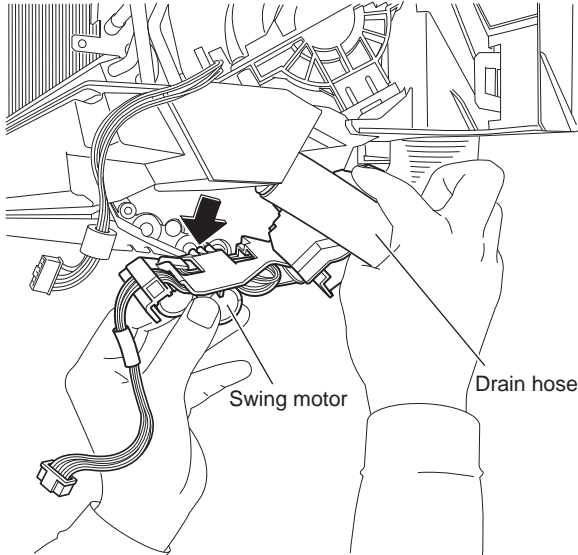
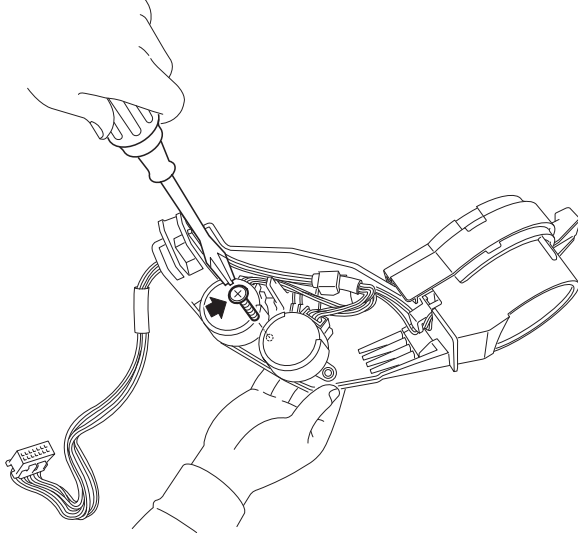
Step	Procedure	Points
3.	Removal of the horizontal swing motors.	
1	<p>Release the interlock rod.</p>  <p>(R9546)</p>	
2	<p>Pull out the drain hose, then the swing motors can be removed.</p>  <p>(R9547)</p>	
3	<p>Remove the screw at the center.</p>  <p>(R9548)</p>	

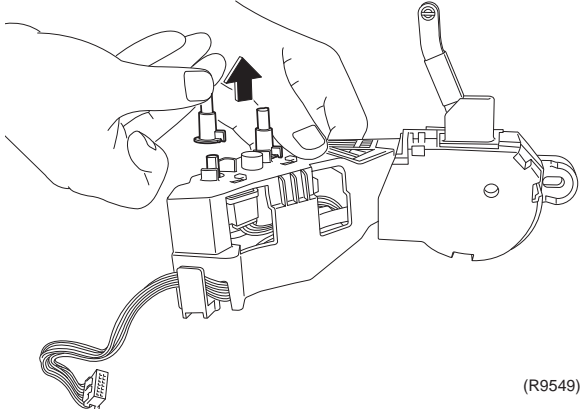
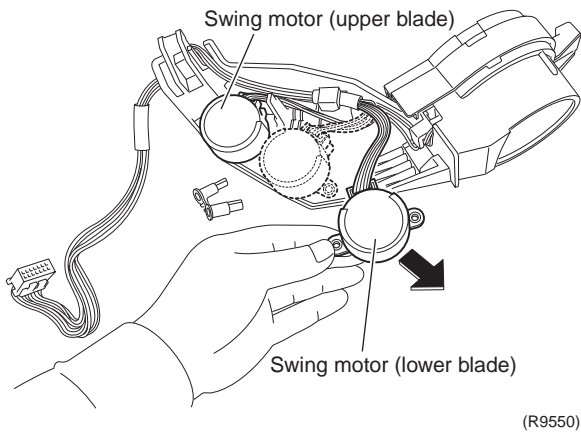
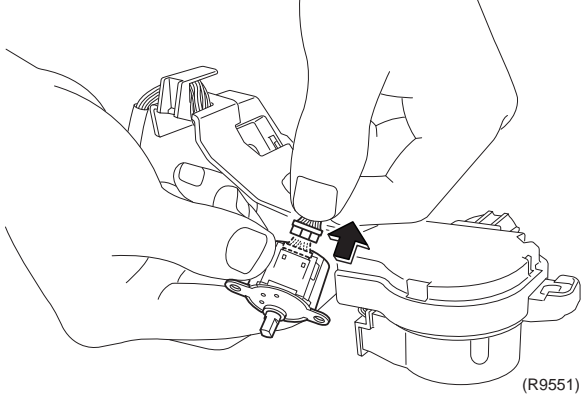
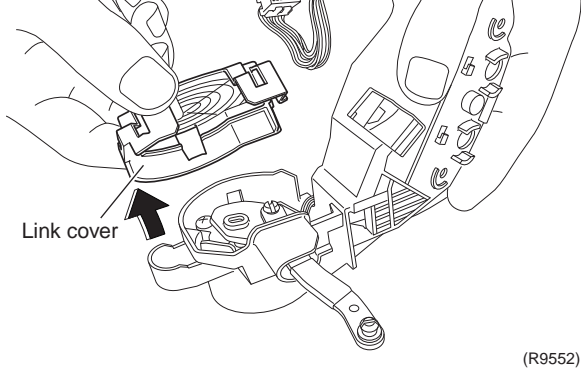
Step	Procedure	Points
4	Remove the 2 pivots.	 <p>(R9549)</p>
5	Remove the stepping motors.	 <p>(R9550)</p>
6	Disconnect the connector to remove the swing motor.	 <p>(R9551)</p>
4.	Removal of the vertical swing motor.	
1	Remove the link cover.	 <p>(R9552)</p>

- When reassembling, set the swing motors in the correct order. Otherwise, they are not completely installed.
- 1) Set the swing motor for upper blade first.
 - 2) Set the swing motor for lower blade.

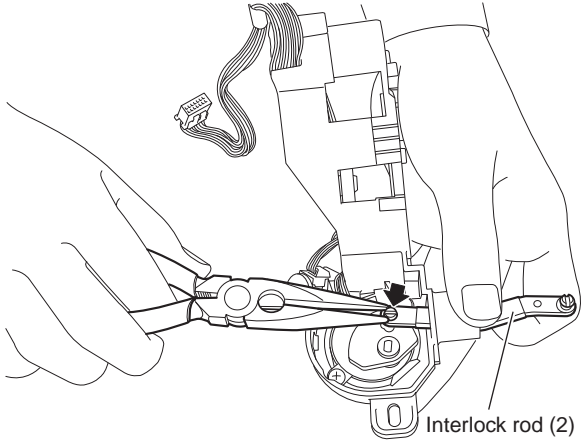
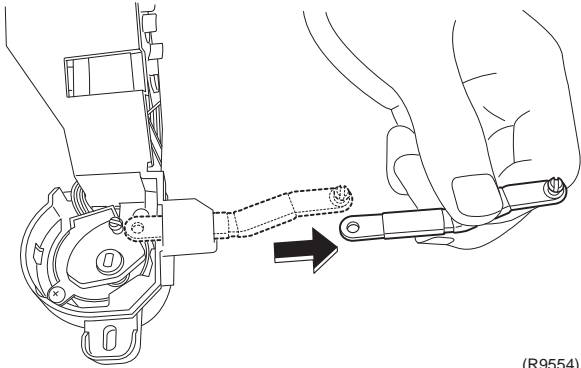
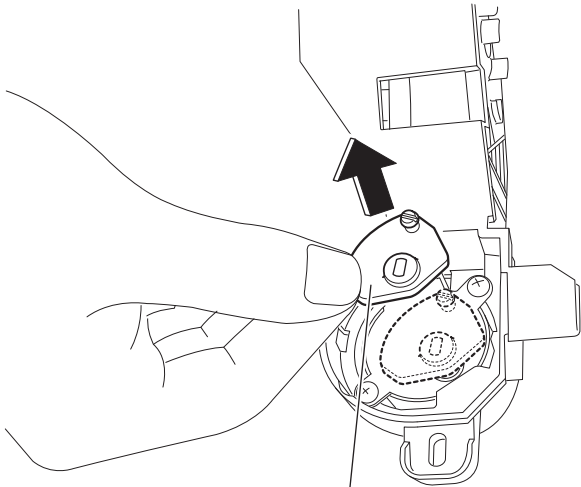
Step		Procedure	Points
2	Remove the interlock rod (2) with pliers.	 <p>Interlock rod (2)</p> <p>(R9553)</p>  <p>(R9554)</p>	
3	Remove the interlock rod (1).	 <p>Interlock rod (1)</p> <p>(R9555)</p>	

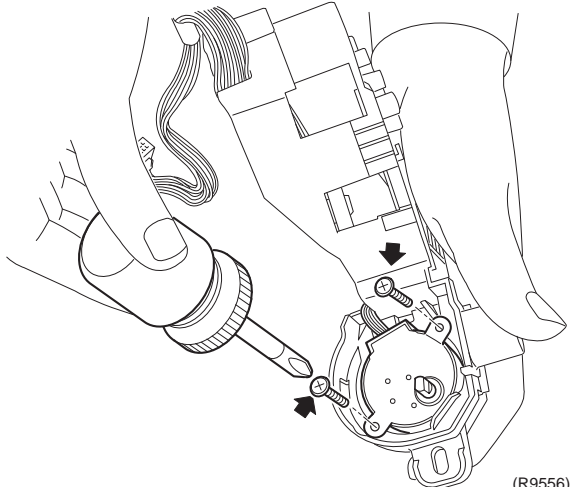
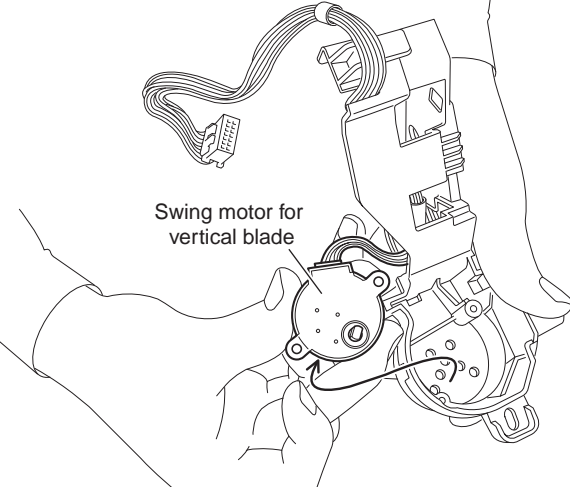
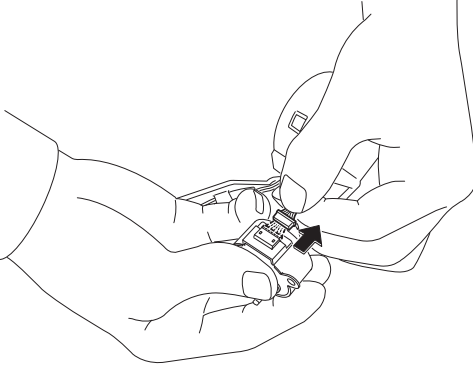
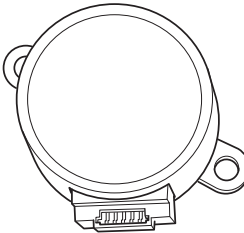
Step	Procedure	Points
4	Remove the 2 screws.	 <p>(R9556)</p>
5	Remove the swing motor for vertical blade.	 <p>Swing motor for vertical blade</p> <p>(R9557)</p>
6	Disconnect the connector.	  <p>(R9558)</p>

1.6 Removal of Fan Motor

Procedure



Warning

Be sure to wait 10 minutes or more after turning off all power supplies before disassembly work.

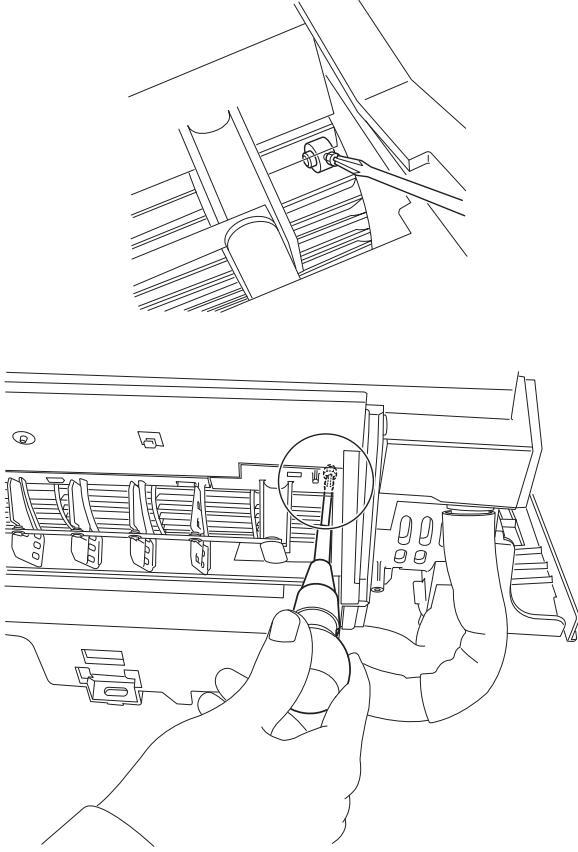
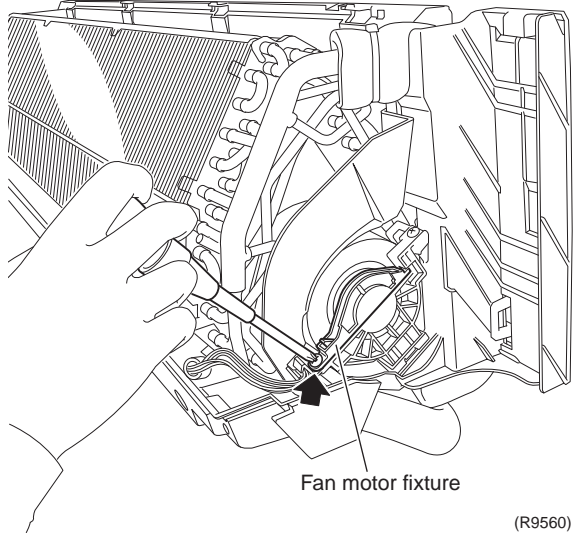
Step	Procedure	Points
<p>1</p>	<p>Loosen the fixing screw of the fan motor from the air outlet.</p>  <p>(R9559)</p>	<p>■ When the screw is loose enough, the rotor can be moved.</p>
<p>2</p>	<p>Remove the screw of the fan motor fixture.</p>  <p>Fan motor fixture</p> <p>(R9560)</p>	

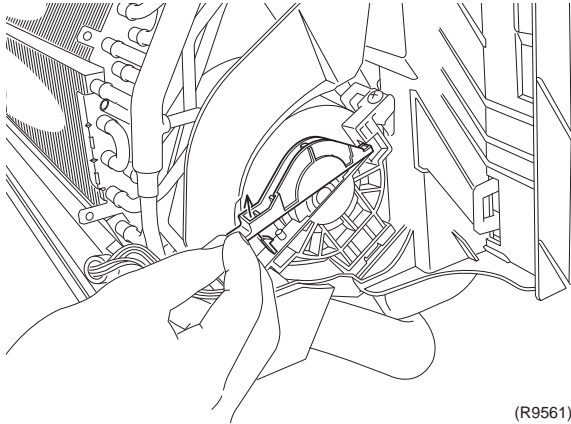
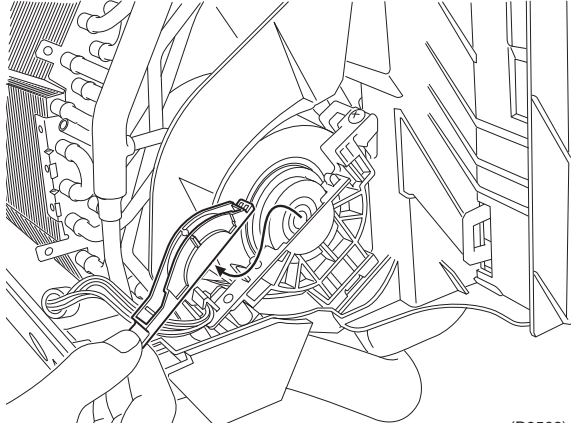
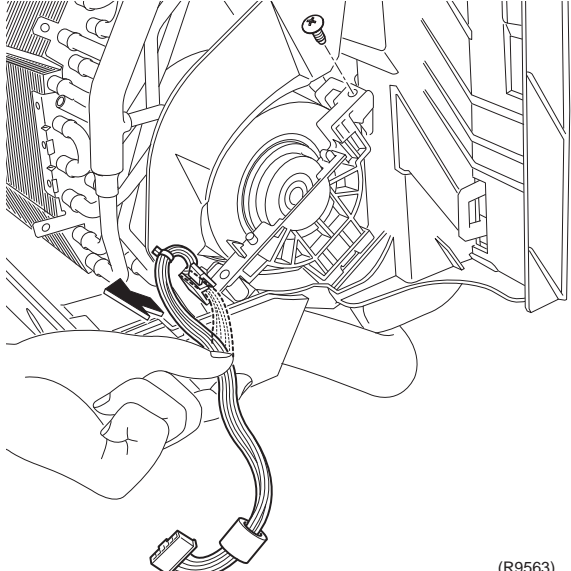
Step	Procedure	Procedure	Points
3	Remove the fan motor fixture by pushing the hook at the front.	 <p>(R9561)</p>  <p>(R9562)</p>	
4	Release the harness from the hook, and remove the screw of the motor mounting plate.	 <p>(R9563)</p>	

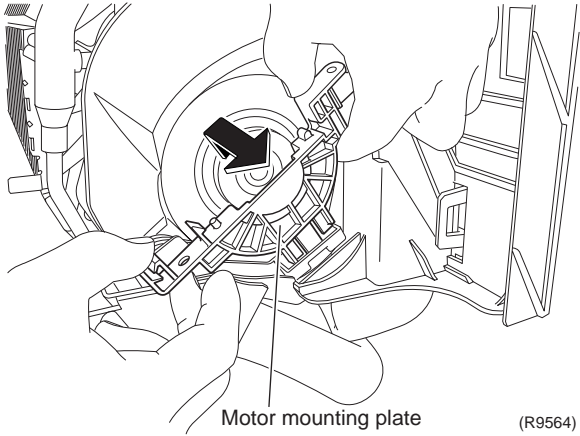
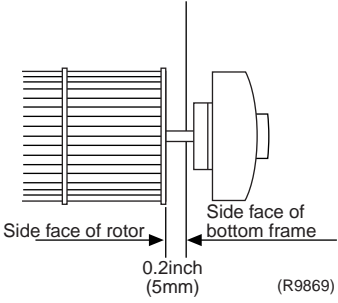
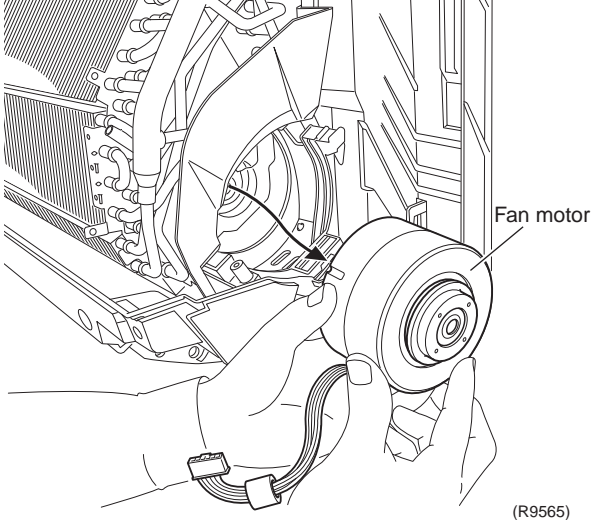
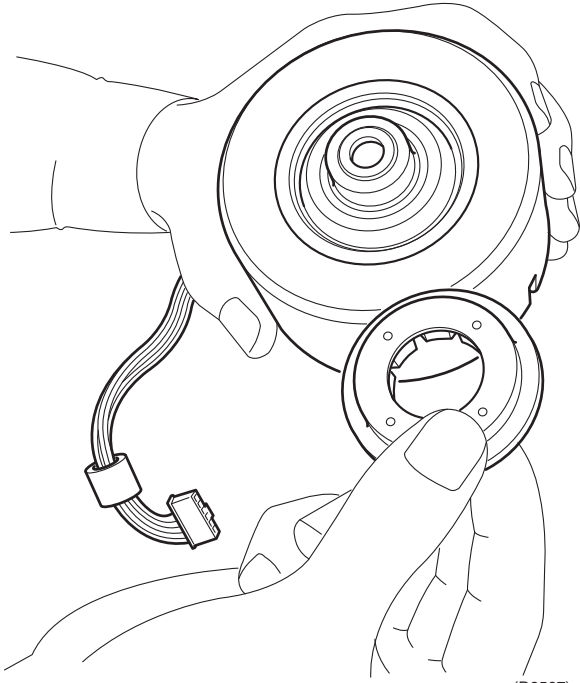
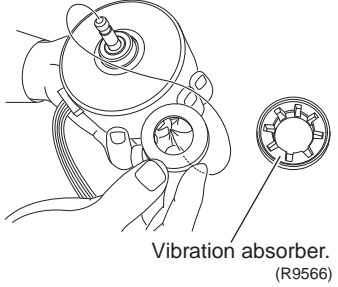
Step		Procedure	Points
5	Remove the motor mounting plate.	 <p>Motor mounting plate (R9564)</p>	<ul style="list-style-type: none"> Reassembling the fan motor When reassembling the fan rotor, provide as much as 0.2inch (5mm) of play between the side face of the rotor and the bottom frame.  <p>Side face of rotor Side face of bottom frame 0.2inch (5mm) (R9869)</p>
6	Remove the fan motor.	 <p>Fan motor (R9565)</p>	
7	Remove the vibration absorber.	 <p>(R9567)</p>	<ul style="list-style-type: none"> When reassembling, engage the vibration absorber completely.  <p>Vibration absorber. (R9566)</p>

1.7 Removal of Heat Exchanger

Procedure

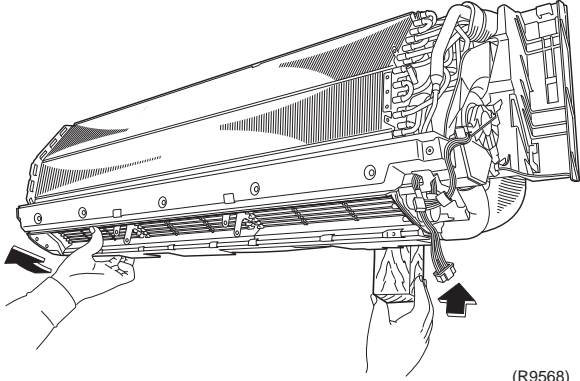
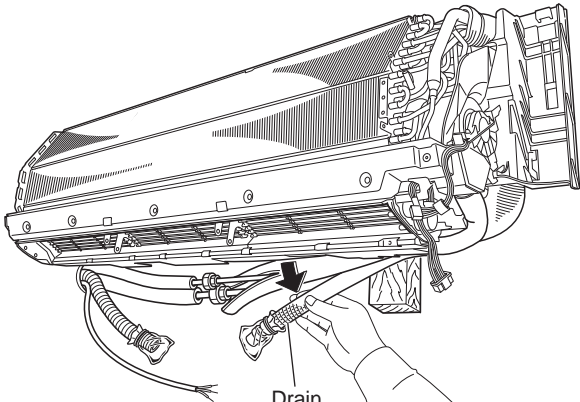
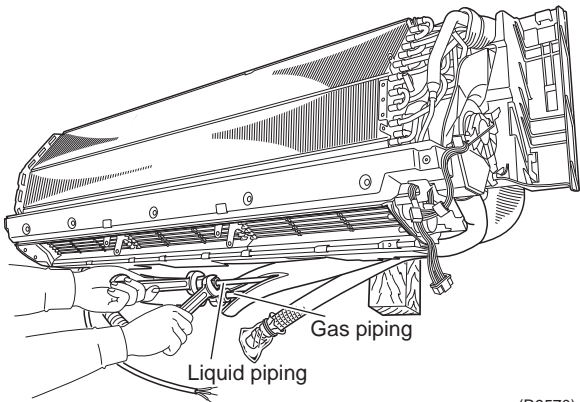

Warning Be sure to wait 10 minutes or more after turning off all power supplies before disassembly work.

Step	Procedure	Points
1. Disconnect the refrigerant piping.		
1 Hold the indoor unit up by a piece of wood etc.	 <p>(R9568)</p>  <p>Drain</p> <p>(R9569)</p>	<p>! Caution If gas leaks, collect all refrigerant from the unit, then repair the spot of leaking. After conducting vacuum drying, recharge proper amount of refrigerant.</p> <p>! Caution Do not contaminate with any gas (including air) other than the specified refrigerant (R-410A) into refrigerant cycle. Contaminating with air or other gas causes abnormal high pressure in refrigerating cycle, and this results in pipe breakage or personal injuries.</p> <ul style="list-style-type: none"> ■ Pay attention so that the residual water in the drain will not make the floor wet. ■ In case that a drain hose is buried inside a wall, remove it after the drain hose in the wall is pulled out.
2 Unscrew the flare nut for gas piping and liquid piping by 2 wrenches.	 <p>Gas piping</p> <p>Liquid piping</p> <p>(R9570)</p>	<ul style="list-style-type: none"> ■ Use 2 wrenches to disconnected pipes. ■ When disconnecting pipes, cover every nozzle with caps so as not to let dust and moisture in.

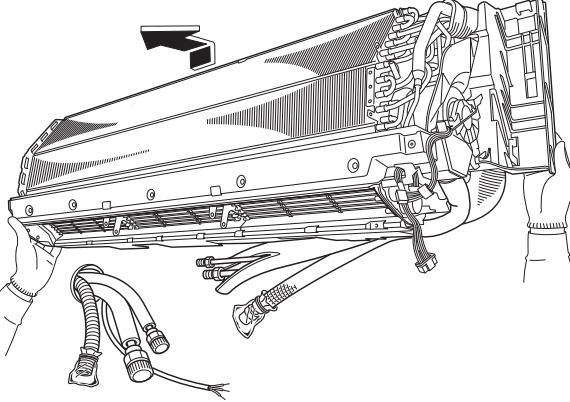
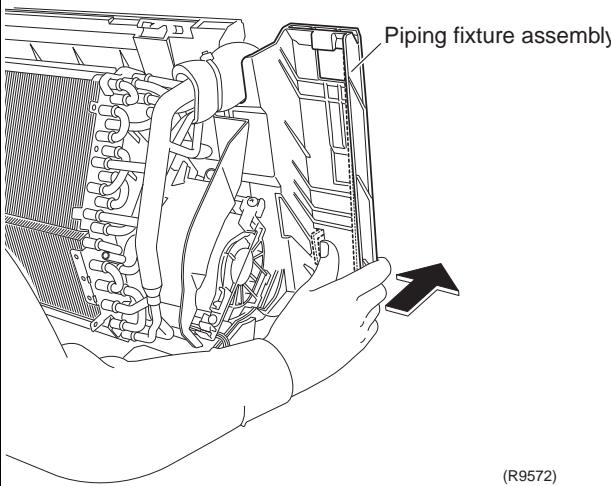
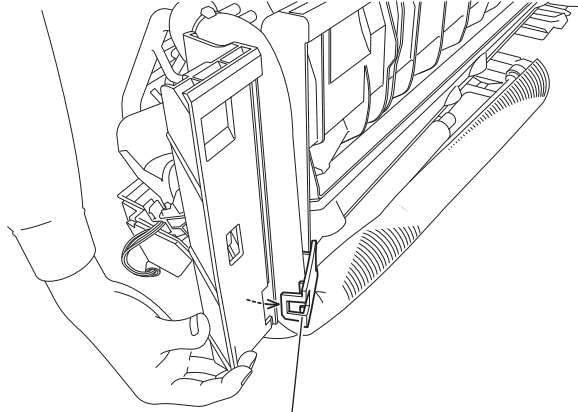
Step	Procedure	Points
2. Removal of the piping fixture.		
1	<p>Detach the indoor unit from the installation plate.</p>  <p>(R9571)</p>	
2	<p>Push the piping fixture assembly to release the piping fixture.</p>  <p>Piping fixture assembly</p> <p>(R9572)</p>  <p>Piping fixture</p> <p>(R9573)</p>	

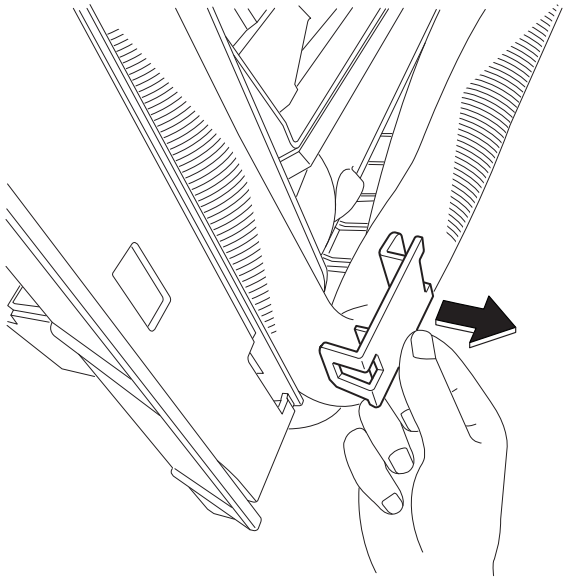
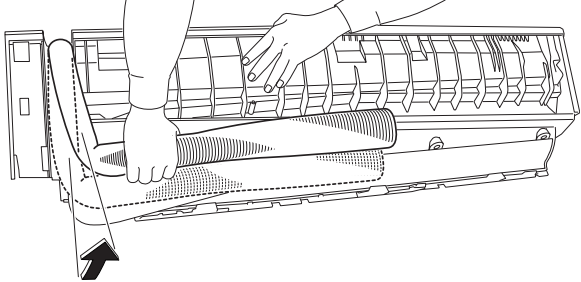
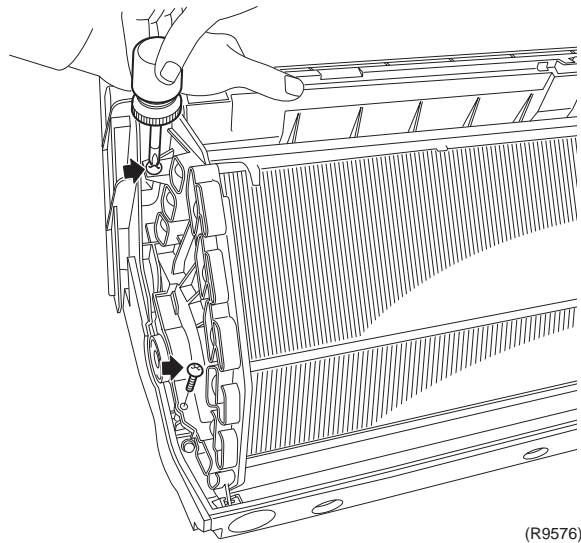
Step	Procedure	Points
3	Remove the piping fixture.  <p style="text-align: right;">(R9574)</p>	
3.	Removal of the heat exchanger.	
1	Widen the auxiliary piping to the extent of 10°~20°.  <p style="text-align: right;">(R9575)</p>	<ul style="list-style-type: none"> ■ At an angle of 10°~20°
2	Remove the 2 screws on the left.  <p style="text-align: right;">(R9576)</p>	

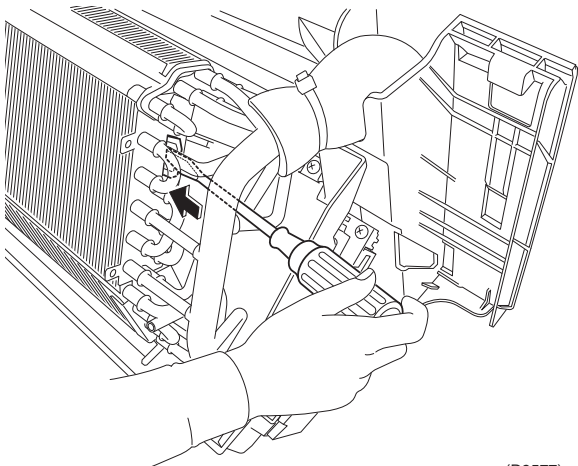
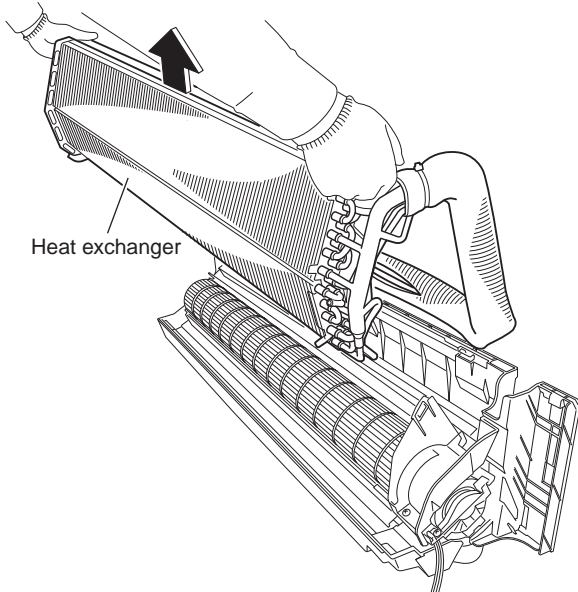
Step	Procedure	Points
3	<p>Push the fixing hooks on the right side and release.</p>  <p>(R9577)</p>	
4	<p>Lift up and remove the heat exchanger.</p>  <p>Heat exchanger</p> <p>(R9578)</p>	<p>⚠ Caution When removing or reinstalling heat exchanger, be sure to wear protective gloves or wrap the heat exchanger with cloths. (Fins can cut fingers.)</p> <ul style="list-style-type: none"> ■ Press the right side of the heat exchanger, and lift up from the left side.

1.8 Removal of Fan Rotor

Procedure



Warning

Be sure to wait 10 minutes or more after turning off all power supplies before disassembly work.

Step	Procedure	Points
1. Remove the right side panel.		
1	Remove the 2 screws.	<ul style="list-style-type: none"> ■ You can remove the fan rotor without detaching the right side panel.
2	Lift the right side panel and remove it.	
2. Removal of the fan rotor.		
1	Remove the screw of the fan motor fixture and remove the fixture.	<ul style="list-style-type: none"> ■ Refer to P.143

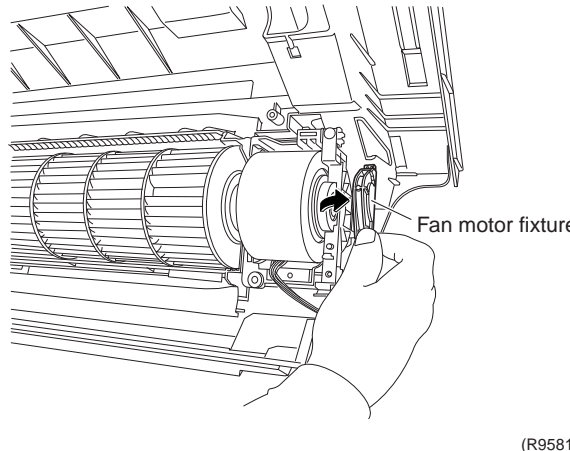
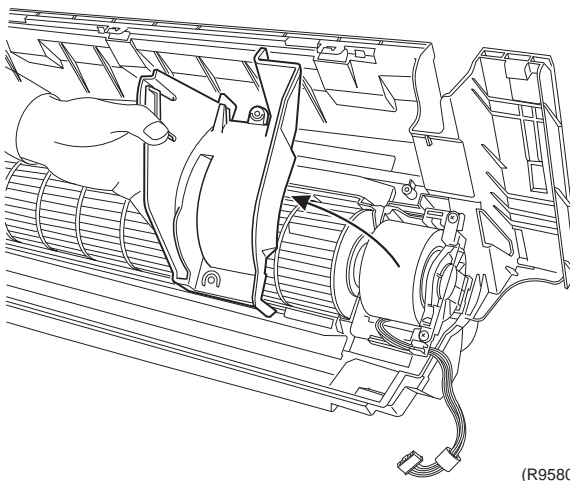
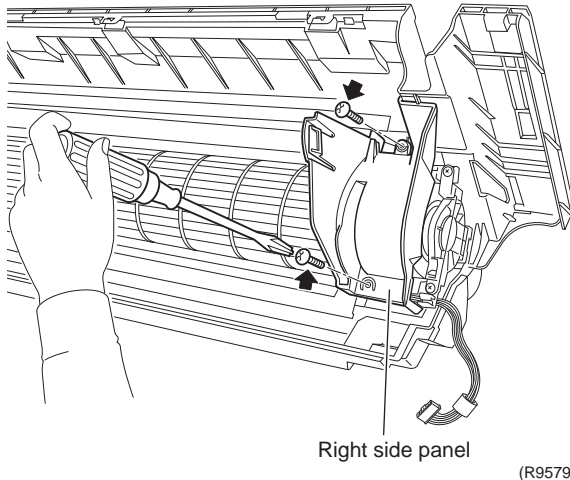

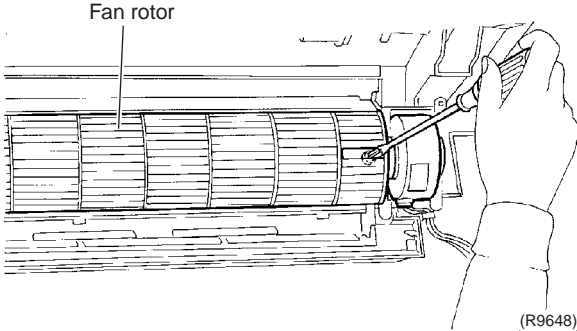
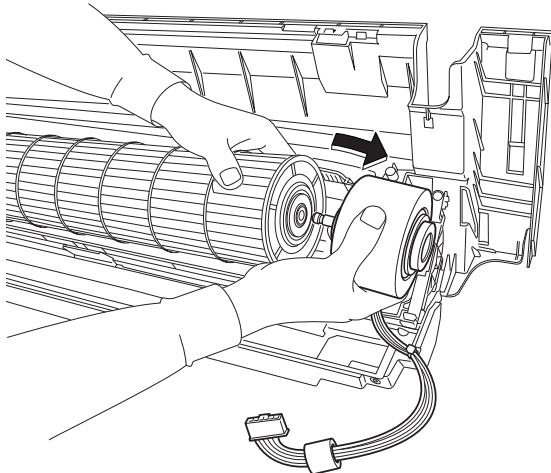
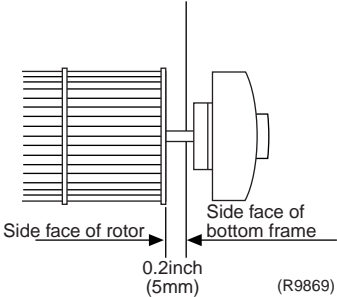
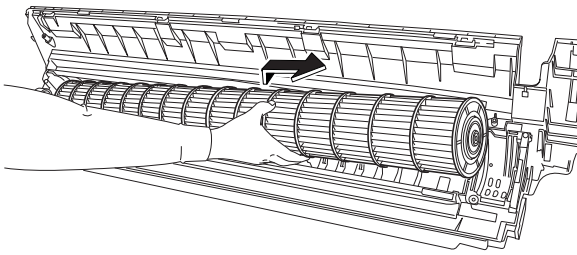
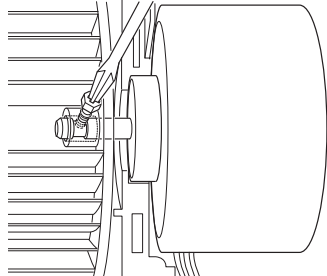
Step		Procedure	Points
2	Remove the fixing screw of the fan rotor.	 <p>(R9648)</p>	
3	Remove the fan motor.	 <p>(R9583)</p>	<p>■ Reassembling the fan motor When reassembling the fan rotor, provide as much as 0.2inch (5mm) of play between the side face of the rotor and the bottom frame.</p>  <p>(R9869)</p>
4	Remove the fan rotor.	 <p>(R9584)</p>	 <p>(R9582)</p> <ol style="list-style-type: none"> ① Insert the fan motor approx. 0.2inch (5mm) ② Tighten the screw until it stops. Then turn the screw by one turn. ③ Move the fan rotor and confirm the fan motor and the fan rotor are installed appropriately. ④ Tighten the screw completely if appropriate. ⑤ If not appropriate, go back to ①.

2. Outdoor Unit

2.1 Removal of Outer Panels

Procedure

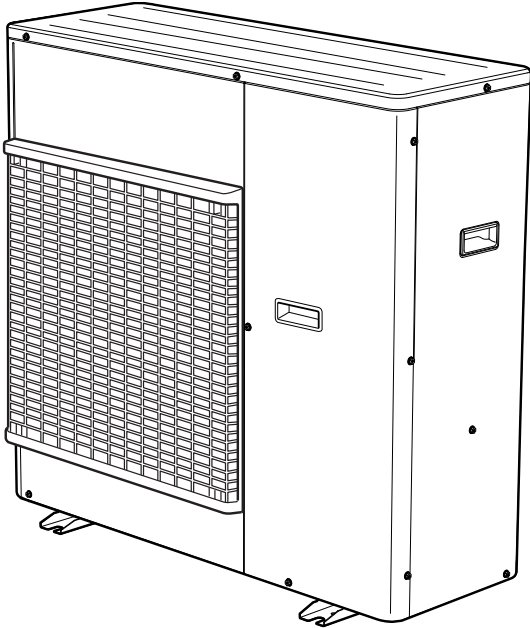
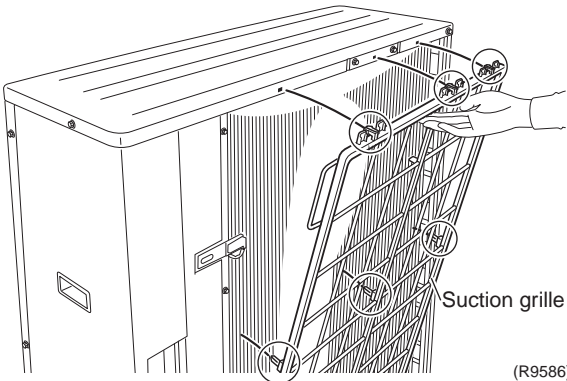
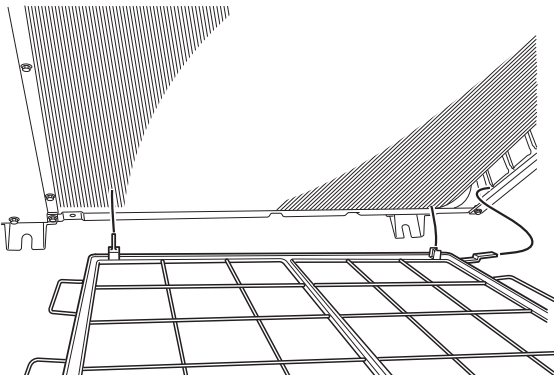

Warning Be sure to wait 10 minutes or more after turning off all power supplies before disassembly work.

Step	Procedure	Points
	<p>External appearance.</p>  <p style="text-align: right;">(R9749)</p>	
<p>1. Removal of the suction grille.</p> <p>1</p> <p>2</p>	<p>1 Release the 3 hooks at the upper first, and then, 3 hooks at the middle.</p>  <p style="text-align: right;">(R9586)</p> <p>2 Release the 3 hooks at the bottom.</p>  <p style="text-align: right;">(R9587)</p>	<p>■ The hooks are secured in the clearances of the heat exchanger fins.</p>

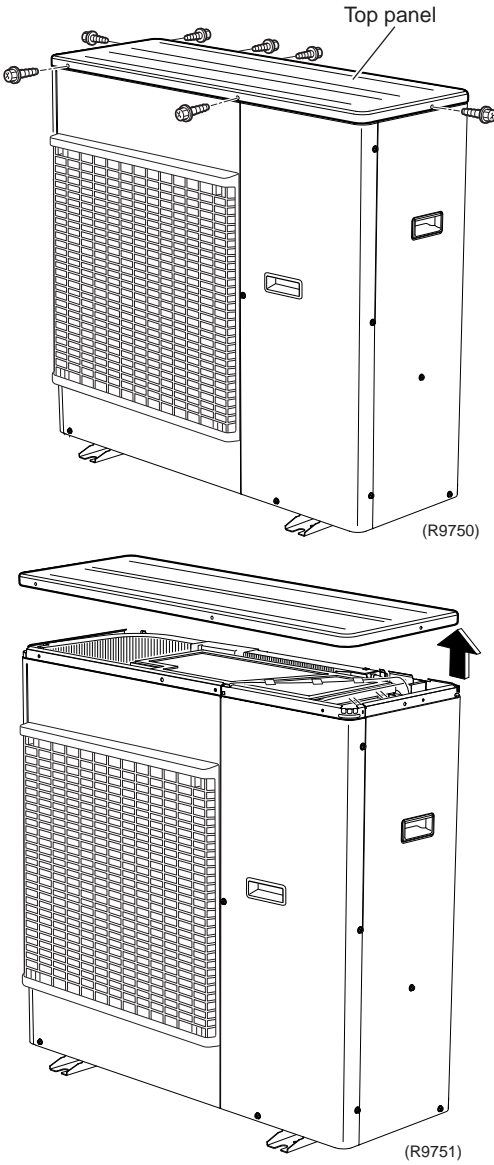
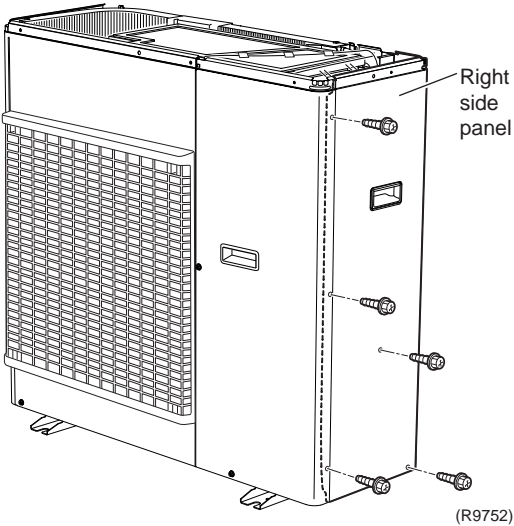
Step	Procedure	Points
<p>2. Removal of the top panel.</p> <p>1 Remove the 7 screws and remove the top panel.</p>	 <p>The diagram illustrates the removal of the top panel in two stages. The first stage shows the outdoor unit with seven screws being removed from the top panel, which is labeled 'Top panel'. The second stage shows the top panel being lifted away from the unit, indicated by an upward-pointing arrow. The unit is labeled (R9750) and (R9751).</p>	
<p>3. Removal of the right side panel.</p> <p>1 Remove the 5 screws.</p>	 <p>The diagram shows the right side panel of the outdoor unit being removed. Five screws are shown being removed from the right side panel, which is labeled 'Right side panel'. The unit is labeled (R9752).</p>	

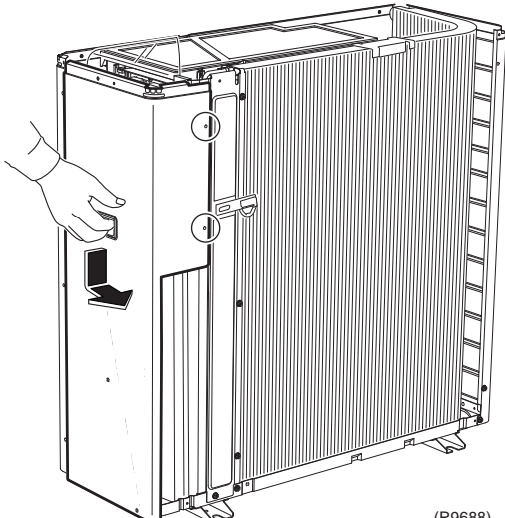
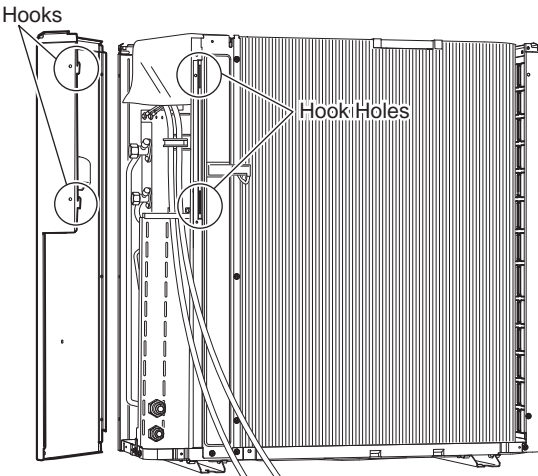
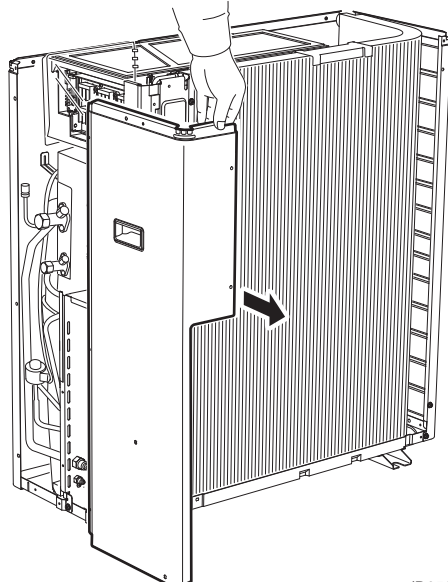
Step	Procedure	Points
2	Slide the panel downward to release 2 hooks on the back side.	 <p>(R9688)</p>  <p>(R9590)</p>
3	Remove the right side panel.	 <p>(R9591)</p>

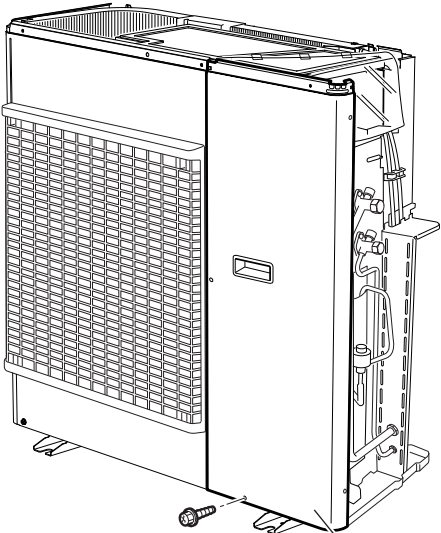
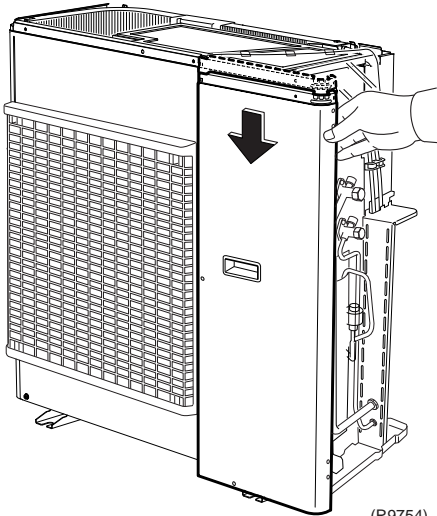
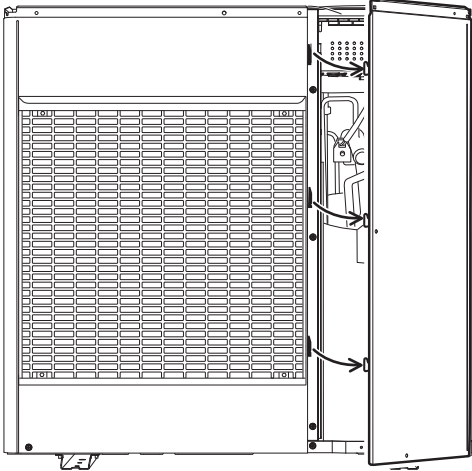
Step	Procedure	Points
4. Removal of the front panel (2)		
1 Remove the 1 screw.	 <p style="text-align: center;">Front panel (2) (R9753)</p>	
2 Slide the panel downward to release the hook.	 <p style="text-align: center;">(R9754)</p>  <p style="text-align: center;">(R9755)</p>	

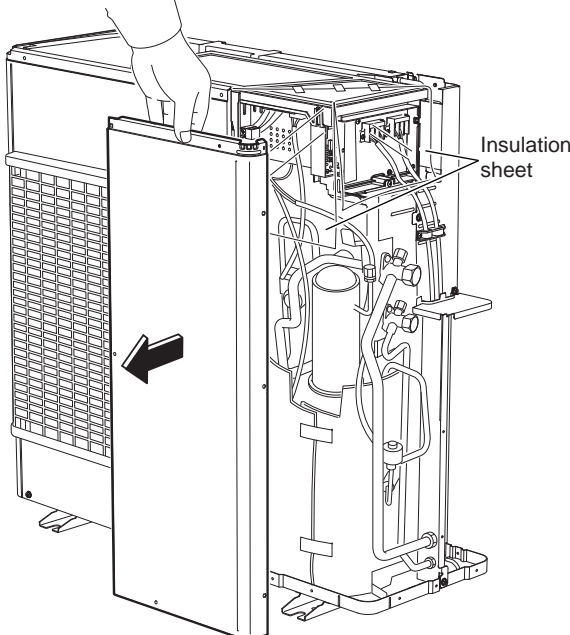
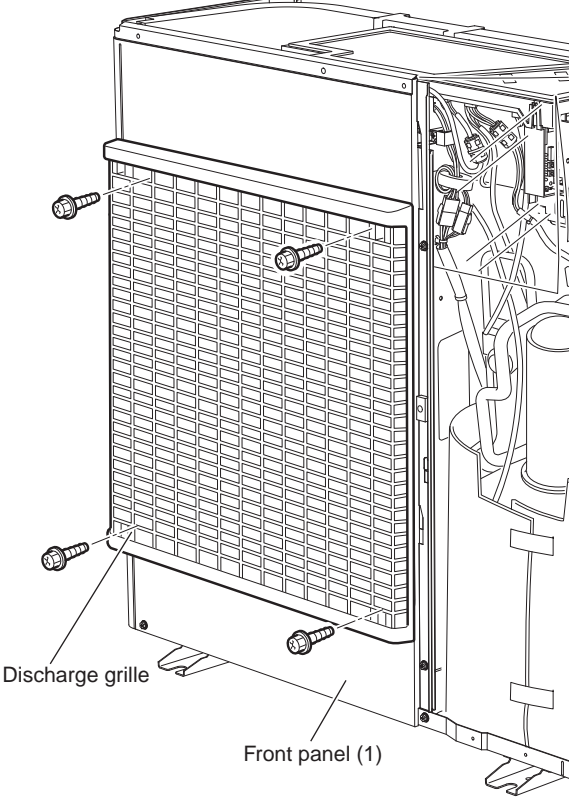
Step	Procedure	Procedure	Points
3	Remove the front panel (2).	 <p style="text-align: right;">(R9756)</p>	<ul style="list-style-type: none"> ■ The insulation sheet is inserted between the front panel (2) and the electrical box.
5.	Removal of the front panel (1)	 <p style="text-align: right;">(R9757)</p>	<ul style="list-style-type: none"> ■ Remove the discharge grille and propeller fan first to remove the front panel (1).
1	Remove the 4 screws on the discharge grille.		

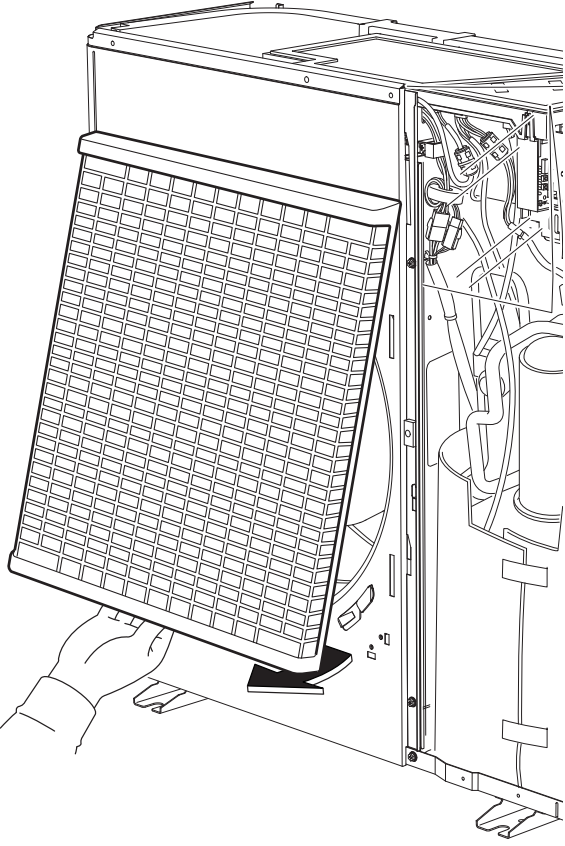
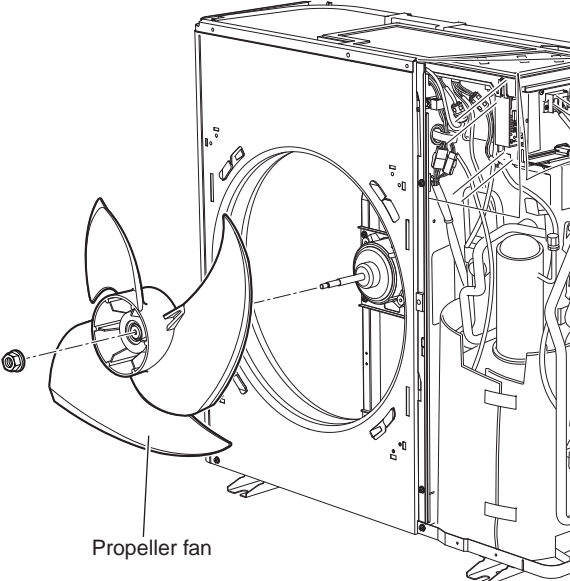
Step		Procedure	Points
2	Pull the bottom of the discharge grille toward you.	 <p>(R9758)</p>	
3	Remove the propeller fan and the fixing nut.	 <p>Propeller fan</p> <p>(R9598)</p>	Fan fixing nut : M8

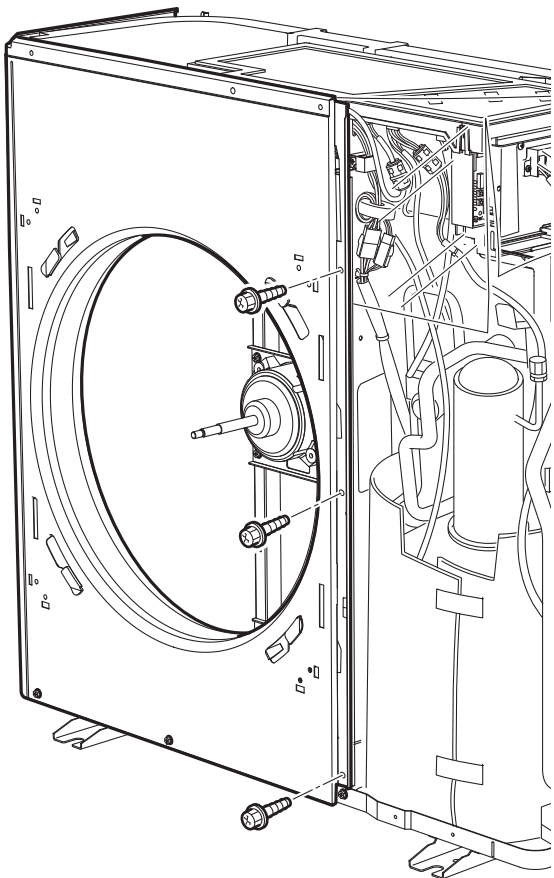
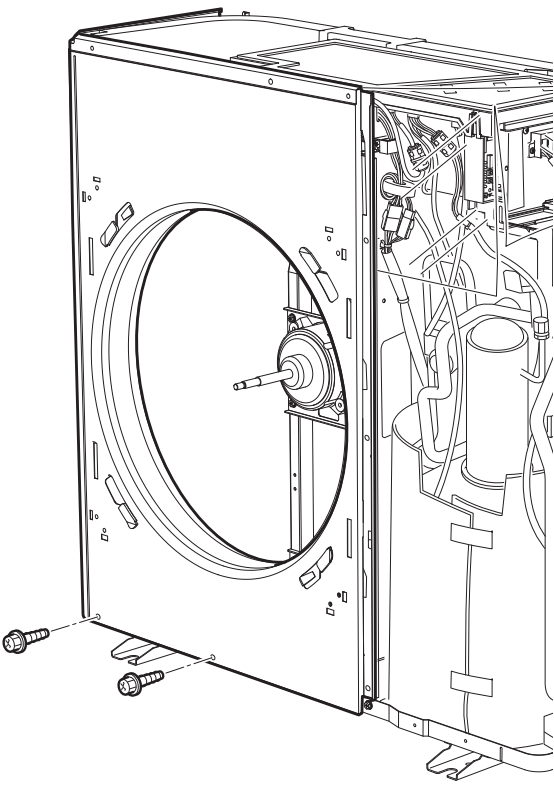
Step	Procedure	Procedure	Points
4	Remove the 3 fixing screws on the partition plate.	 <p>(R9599)</p>	
5	Remove the 2 screws at the bottom left of the front.	 <p>(R9600)</p>	

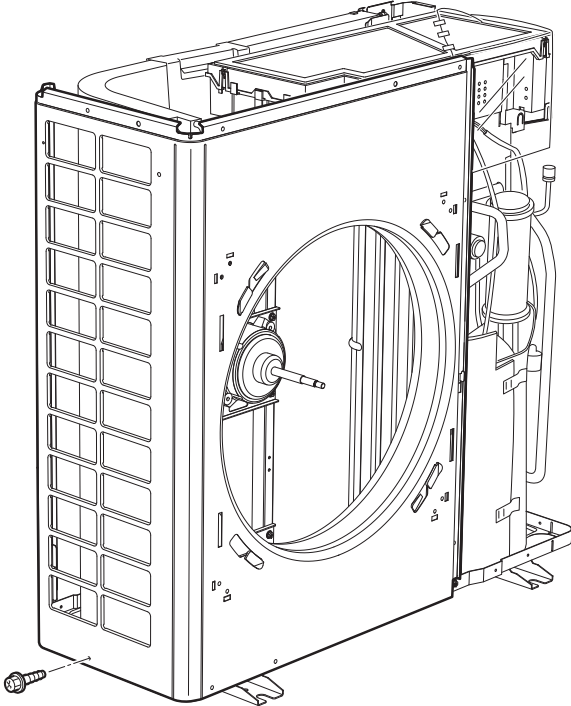
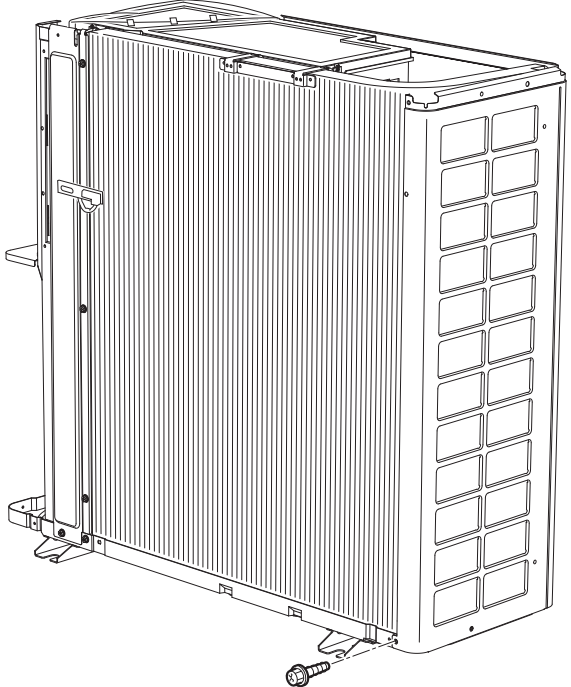
Step		Procedure	Points
6	Remove the screw at the bottom of the left side.	 <p>(R9601)</p>	
7	Remove the screw at the bottom of the back side.	 <p>(R9602)</p>	

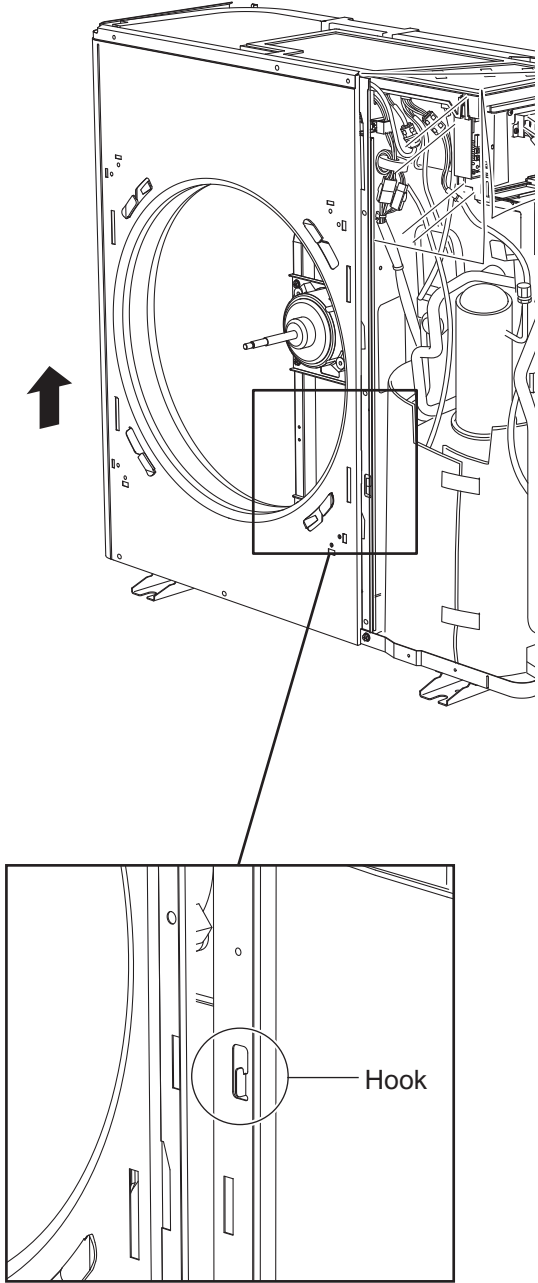
Step		Procedure	Points
8	The front panel (1) is provided with a hook on its front. Lift the front panel off position to remove it.	 <p>(R9603)</p>	

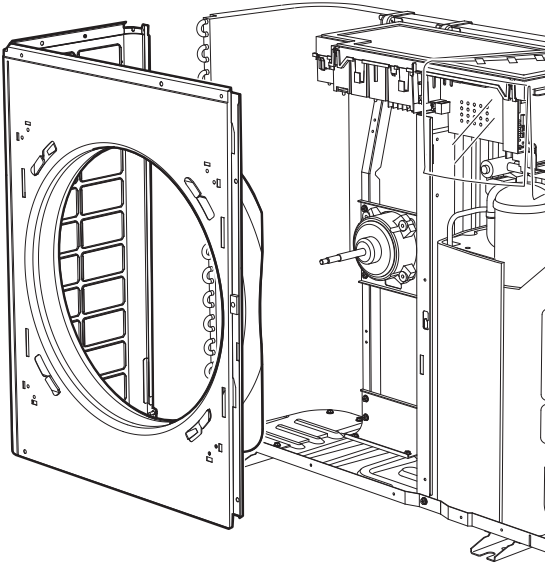
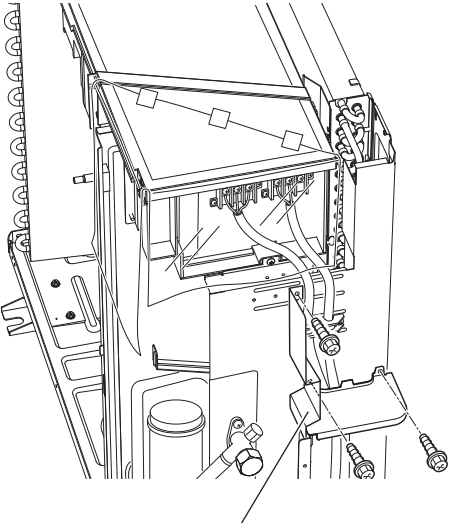
Step	Procedure	Procedure	Points
9	Remove the front panel (1).	 <p>(R9604)</p>	<ul style="list-style-type: none"> ■ The insulation sheet is inserted between the front panel (1) and the partition plate.
6.	Removal of the rear panel	 <p>Partition plate (2)</p> <p>(R9759)</p>	

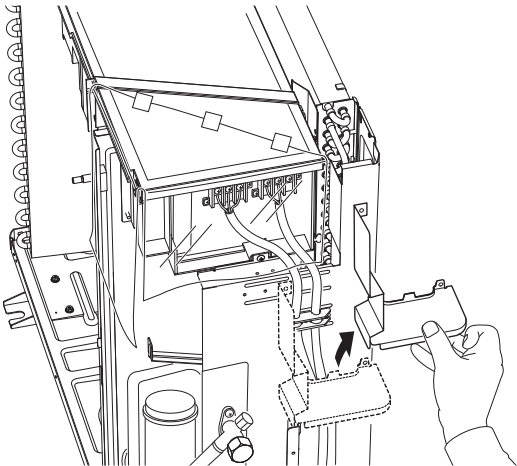
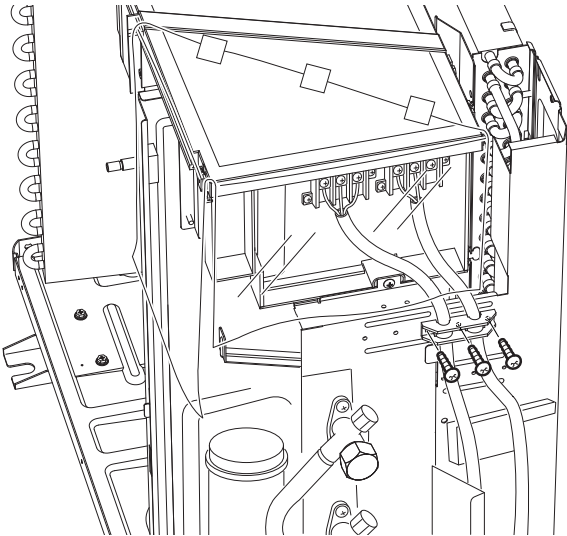
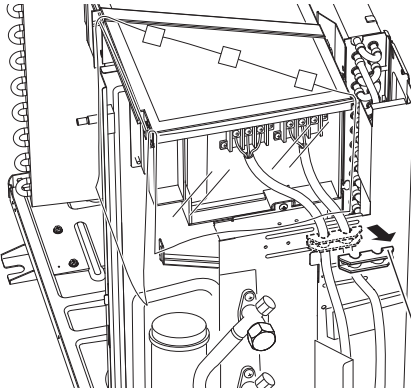
Step		Procedure	Points
2	Lift up slightly and remove the partition plate (2).	 <p>(R9760)</p>	
3	Remove the 3 screws.	 <p>(R9607)</p>	
4	Remove the wire fixing plate.	 <p>Wire fixing plate</p> <p>(R9608)</p>	

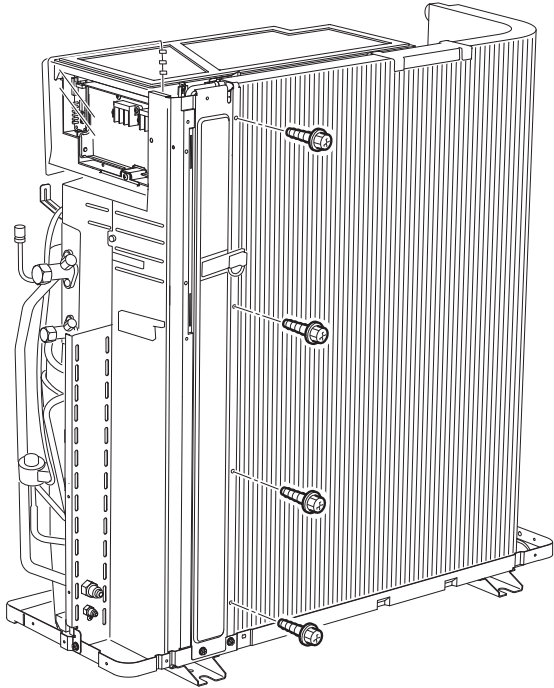
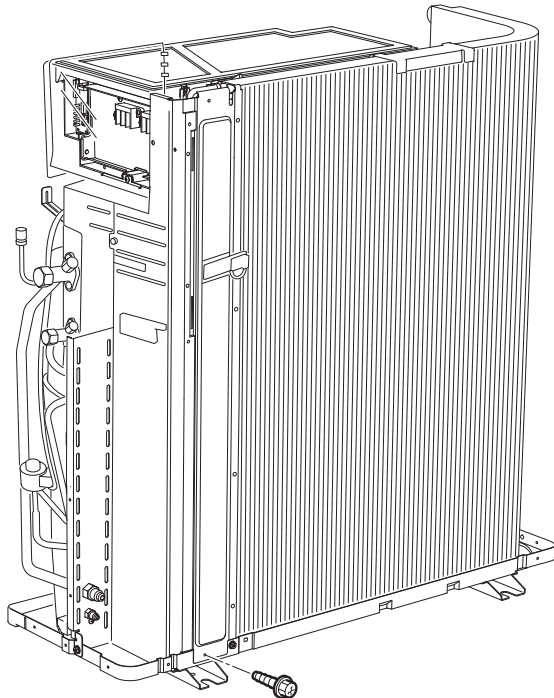
Step		Procedure	Points
5	Remove the 4 fixing screws on the partition plate.	 <p>(R9609)</p>	
6	Remove the fixing screw from the bottom frame.	 <p>(R9610)</p>	

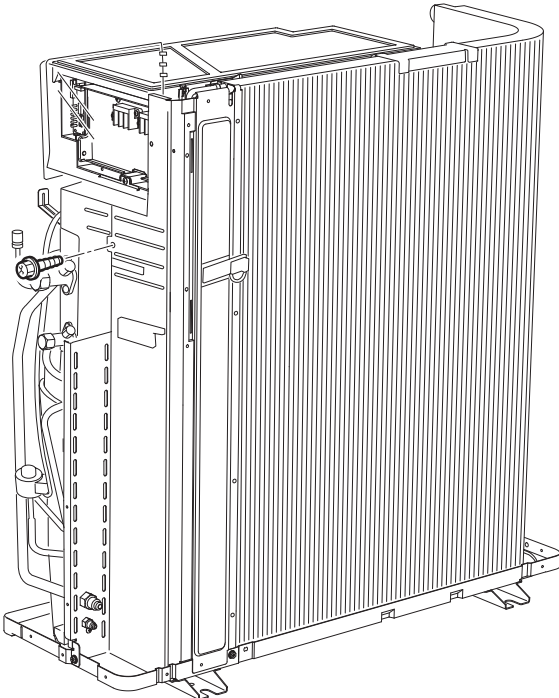
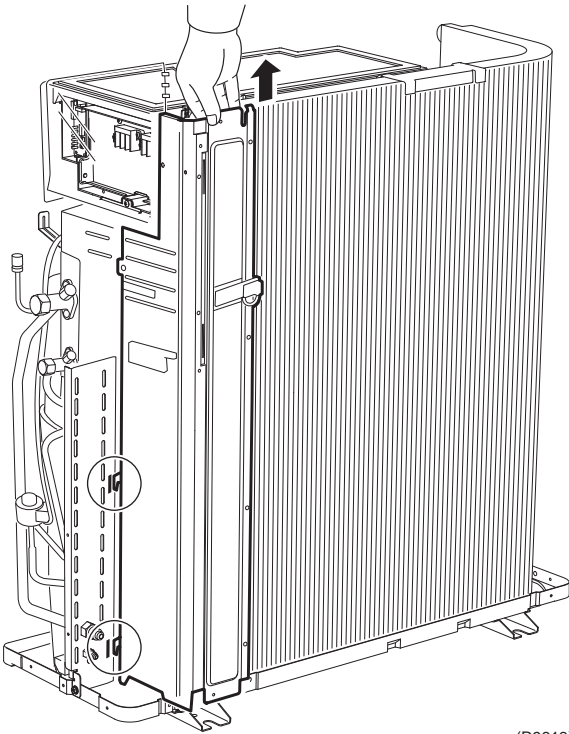
Step	Procedure	Procedure	Points
7	Remove the fixing screw from the shut-off valve mounting plate.	 <p>(R9612)</p>	
8	Lift the panel upward to release the 2 hooks and remove it.	 <p>(R9613)</p>	

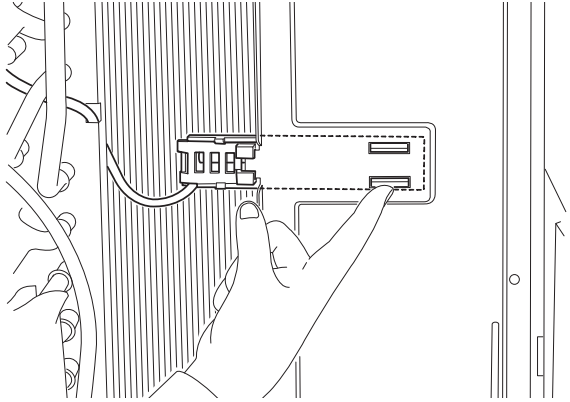
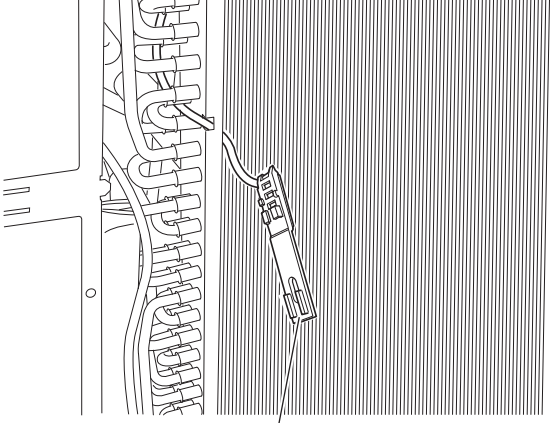
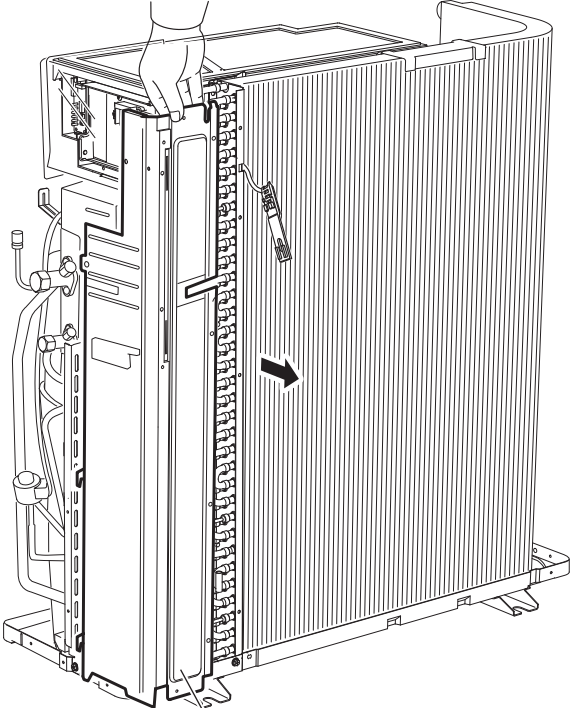
Step		Procedure	Points
9	Push the hooks of the outdoor air thermistor from inner-side.	 <p>(R9615)</p>	
10	The outdoor air thermistor is now released.	 <p>Outdoor air thermistor (R9616)</p>	
11	Remove the rear panel.	 <p>Rear panel (R9614)</p>	

2.2 Removal of the Electrical Box

Procedure

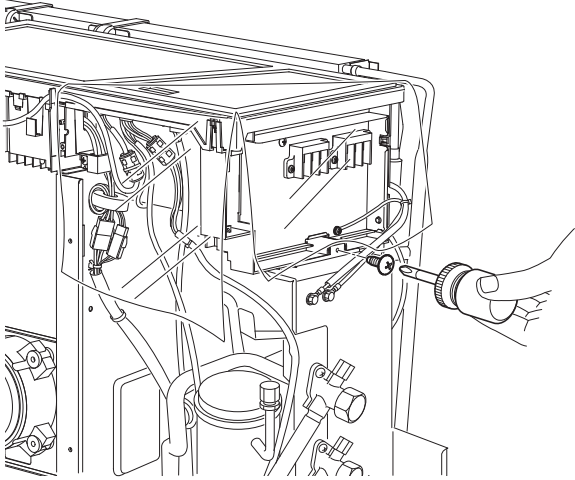
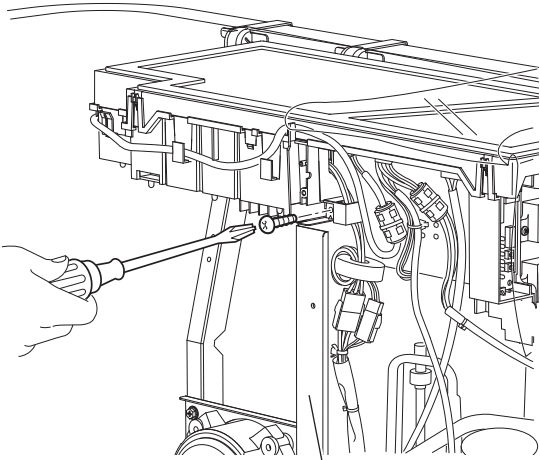
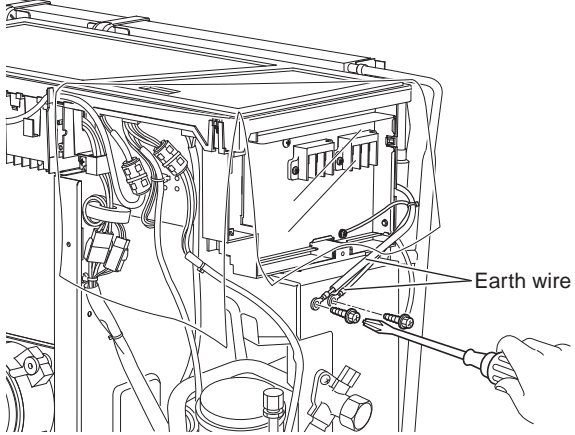

Warning Be sure to wait 10 minutes or more after turning off all power supplies before disassembly work.

Step	Procedure	Points
1	<p>Remove the fixing screw from the shut-off valve mounting plate.</p>  <p style="text-align: right;">(R9617)</p>	
2	<p>Remove the fixing screw on the partition plate.</p>  <p style="text-align: center;">Partition plate</p> <p style="text-align: right;">(R9618)</p>	
3	<p>Remove the 2 screws to detach the ground wires.</p>  <p style="text-align: right;">Earth wire</p> <p style="text-align: right;">(R9619)</p>	

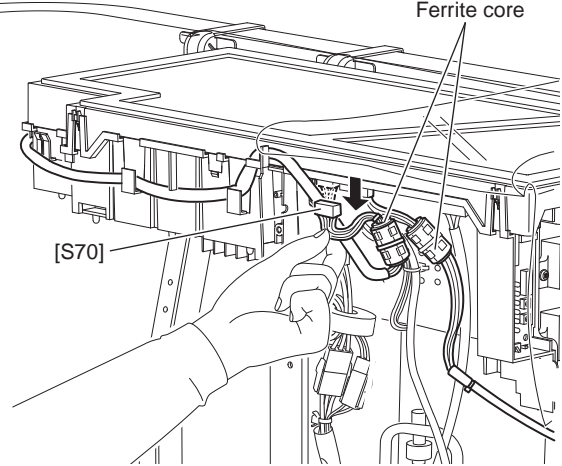
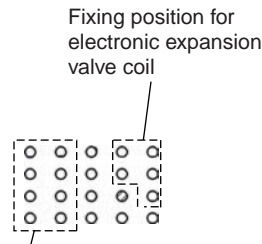
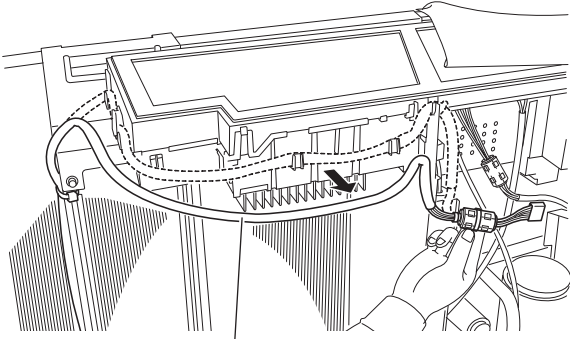
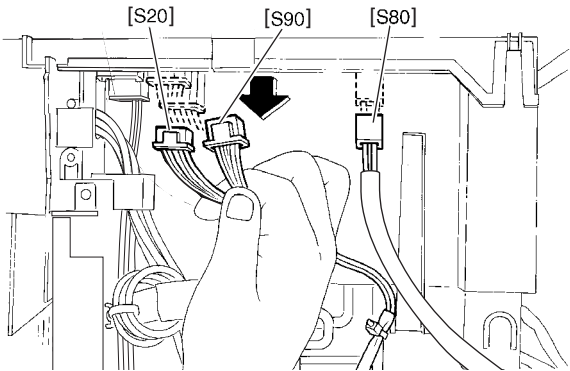
Step		Procedure	Points
4	<p>Disconnect the connector for fan motor [S70] and release the 2 ferrite cores attached to the electrical box with clamp.</p>	 <p>Ferrite core</p> <p>[S70]</p> <p>(R9620)</p>	<ul style="list-style-type: none"> ■ When reassembling, insert the clamp into the small hole.  <p>Fixing position for electronic expansion valve coil</p> <p>Fixing position for ferrite core of fan motor</p> <p>(R9878)</p>
5	<p>The illustration shows arrangement of the fan motor lead wire.</p>	 <p>Fan motor lead wire</p> <p>(R9621)</p>	<ul style="list-style-type: none"> ■ Fix the valves so that the tension does not twist the PCB assembly when connecting the connectors.
6	<p>Disconnect the connectors of the front side. [S20]: electronic expansion valve coil [S80]: four-way valve coil [S90]: thermistors (discharge pipe, outdoor air, heat exchanger)</p>	 <p>[S20] [S90] [S80]</p> <p>(R9622)</p>	

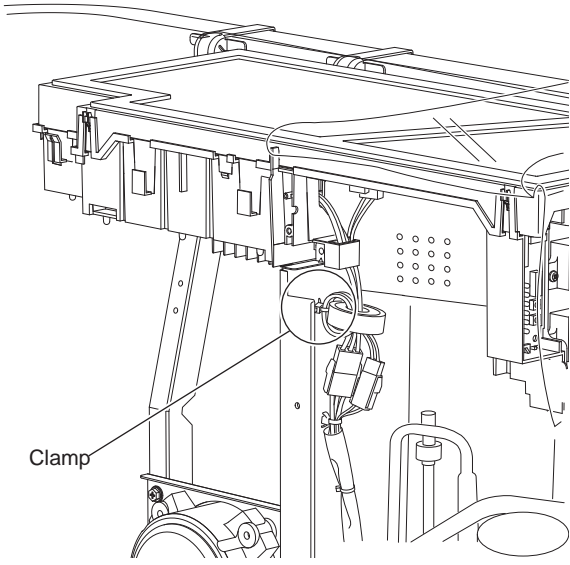
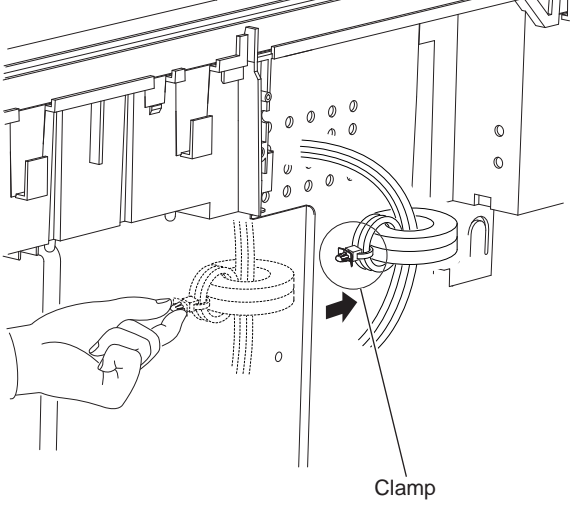
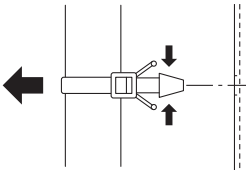
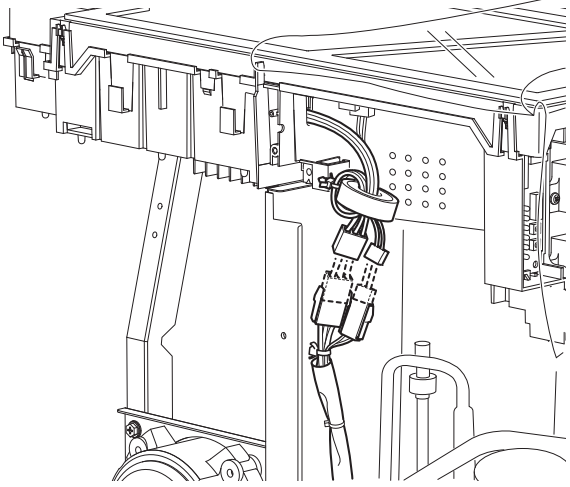
Step		Procedure	Points
7	Release the OL wire harness and the compressor wire harness together from the partition.	 <p style="text-align: right;">(R9623)</p>	
8	Pull out the clamp.	 <p style="text-align: right;">(R9624)</p>	<ul style="list-style-type: none"> ■ Detach the clamp. ■ Just pull the push-mount type out of position. 
9	Disconnect the relay connector of the OL and the compressor.	 <p style="text-align: right;">(R9625)</p>	

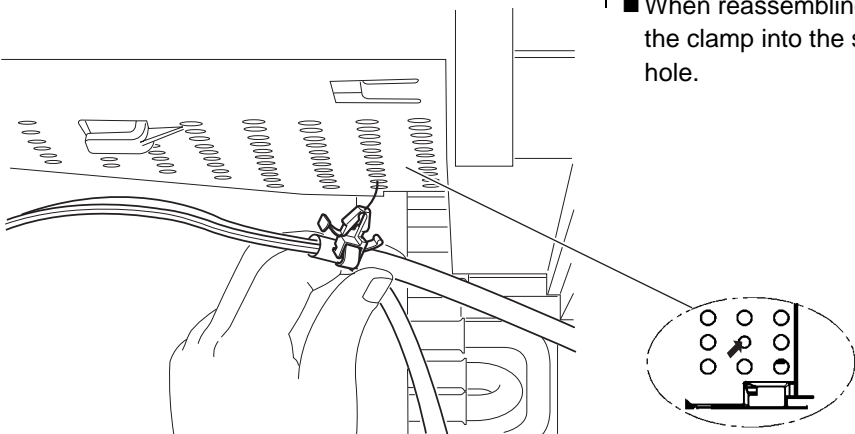
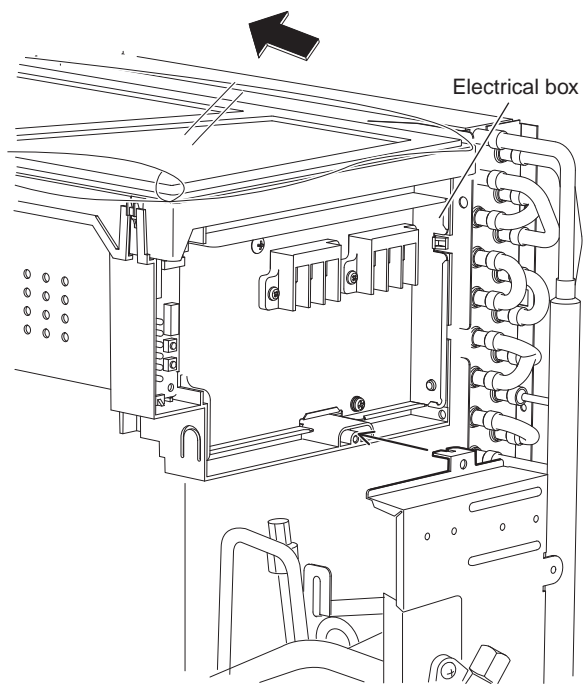
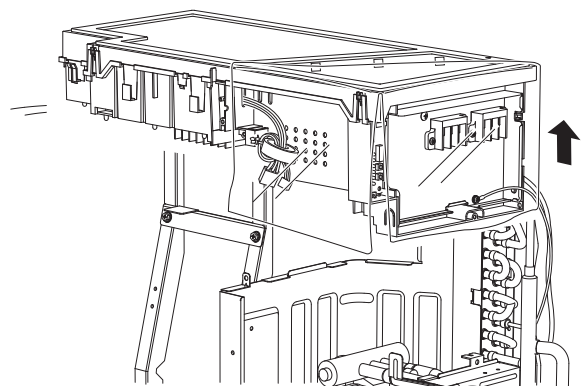
Step	Procedure	Procedure	Points
10	Pull out the clamp of the thermistor harness from the bottom of the electrical box.	 <p>(R9626)</p>	<ul style="list-style-type: none"> ■ When reassembling, insert the clamp into the small hole.
11	Slide the electrical box leftward to release the hook on the right side of the box.	 <p>(R9627)</p>	
12	Lift up the electrical box to remove it.	 <p>(R9628)</p>	

2.3 Removal of PCB

Procedure

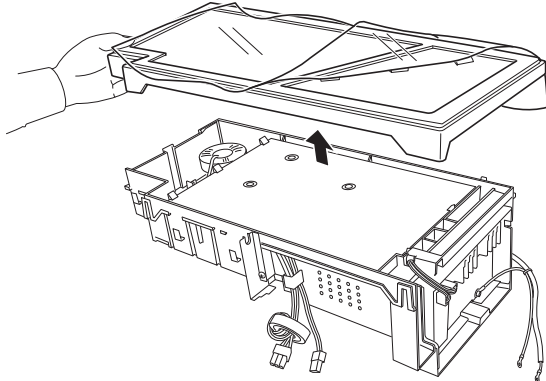
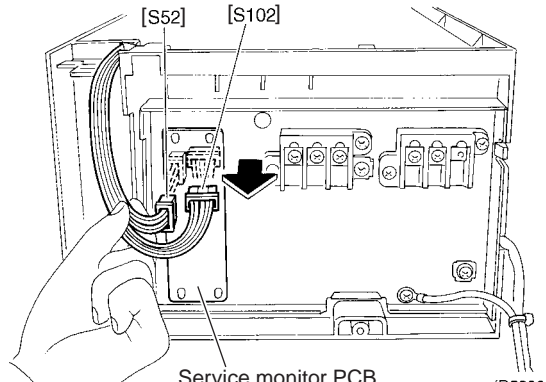
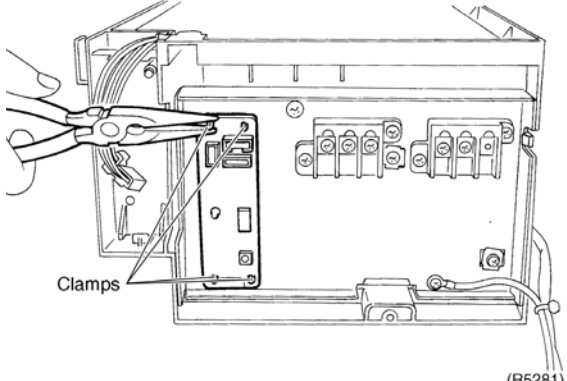
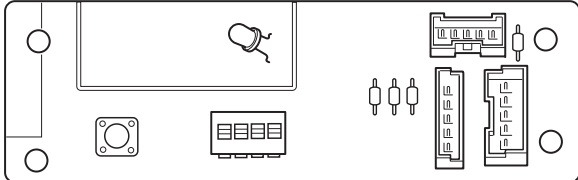

Warning Be sure to wait 10 minutes or more after turning off all power supplies before disassembly work.

Step	Procedure	Points
<p>■ Remove the electrical box before hand.</p>		
<p>1 Remove the cover.</p>	 <p>(R9611)</p>	
<p>2 Disconnect the connectors of the service monitor PCB for the control PCB [S52, S102].</p>	 <p>Service monitor PCB</p> <p>(R5280)</p>	
<p>3 Release the 4 clamps with pliers.</p>	 <p>Clamps</p> <p>(R5281)</p>  <p>(R9629)</p>	

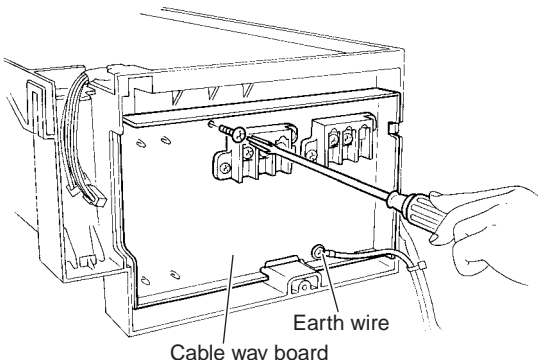
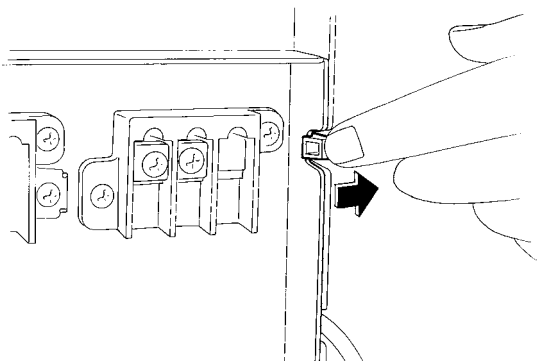
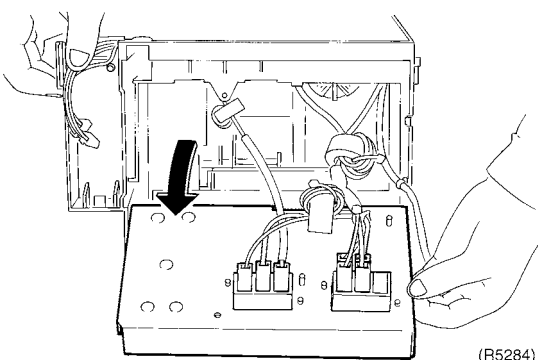
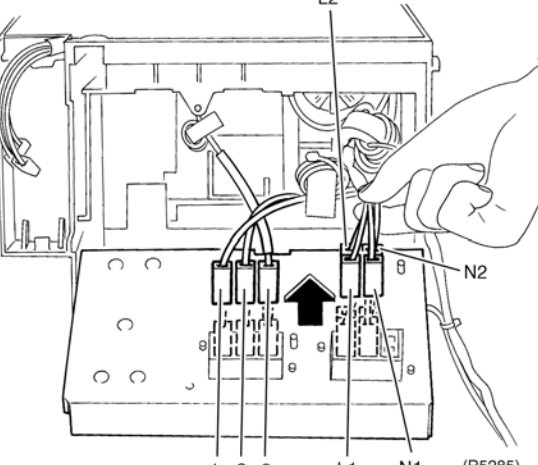
Step		Procedure	Points
4	Remove the fixing screw of the cable way board and disconnect the ground wire.	 <p>(R5282)</p>	
5	Release the hook on the right.	 <p>(R5283)</p>	
6	Open the cable way board.	 <p>(R5284)</p>	
7	Disconnect the harnesses.	 <p>(R5285)</p>	<p>1: Black 2: White 3: Red L1: Black L2: Brown N1: White N2: Blue</p>

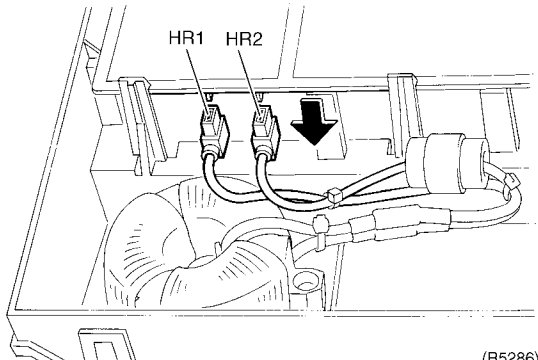
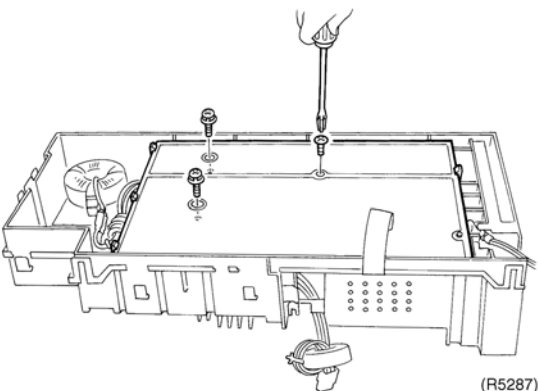
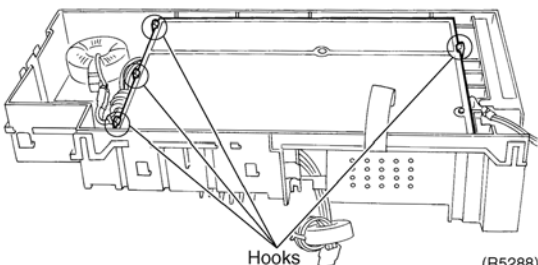
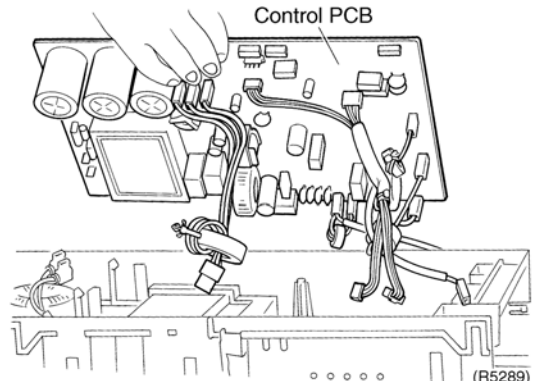
Step		Procedure	Points
8	Disconnect the 2 harnesses for the reactor (HR1, HR2).	 <p>(R5286)</p>	
9	Remove the 3 fixing screws for the main PCB.	 <p>(R5287)</p>	
10	Release the 4 hooks.	 <p>Hooks (R5288)</p>	
11	Lift up and remove the control PCB.	 <p>Control PCB (R5289)</p>	

2.4 Removal of Fan Motor

Procedure



Warning Be sure to wait 10 minutes or more after turning off all power supplies before disassembly work.

Step	Procedure	Procedure	Points
1	Cut the clamps at 2 locations.	<p>(R9630)</p>	
2	Remove the 2 screws at the bottom first.		
3	Next, remove the 2 top screws.	<p>(R6442)</p>	<p>Be sure to remove the bottom screws first. If the top screws are removed first, the fan motor, the center of gravity of which is toward the front, may tilt down or fall, causing an injury.</p>
4	Remove the fan motor.	<p>Fan motor</p> <p>(R6443)</p>	<p>When reassembling, be sure to place the wire harness lower.</p> <p>Harness</p> <p>(R6444)</p>

2.5 Removal of Coils / Thermistors

Procedure



Warning Be sure to wait 10 minutes or more after turning off all power supplies before disassembly work.

Step	Procedure	Points
1. Removal of the electronic expansion valve coil	<div data-bbox="196 436 472 531"> <p>1 Pull the electronic expansion valve coil out of position.</p> </div> <div data-bbox="500 411 1084 890"> </div> <div data-bbox="927 905 987 926">(R9631)</div>	
2. Removal of the thermistors	<div data-bbox="196 982 448 1045"> <p>1 Pull out the heat exchanger thermistor.</p> </div> <div data-bbox="516 993 1073 1413"> </div> <div data-bbox="719 1434 1065 1461">Heat exchanger thermistor (R9632)</div>	

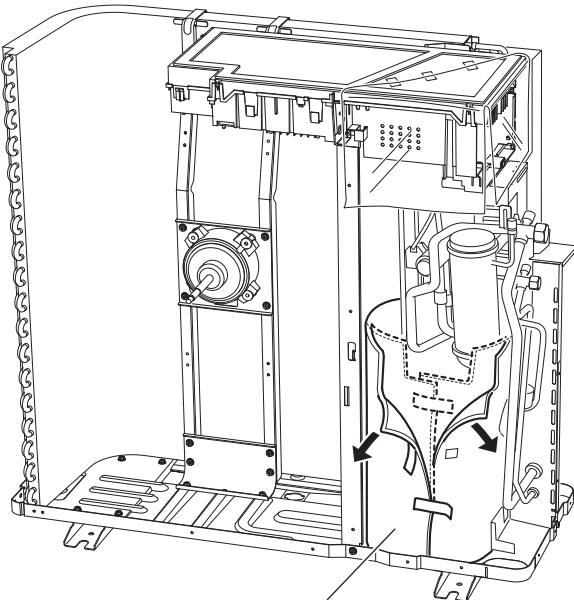
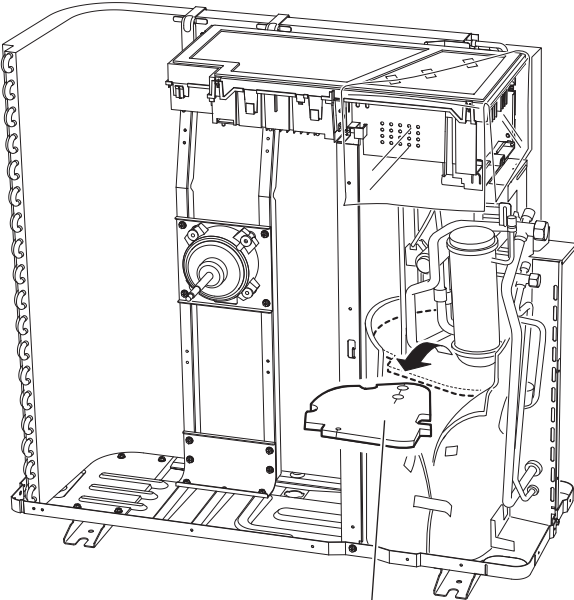
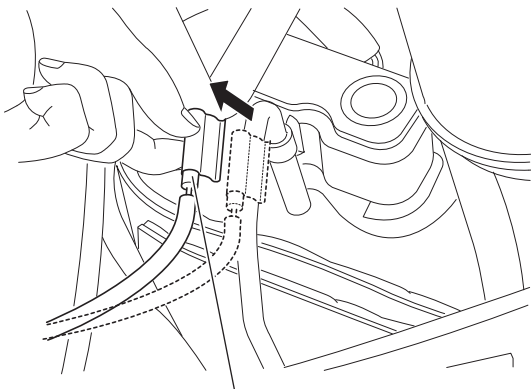
Step		Procedure	Points
2	Slightly open the sound blanket.	 <p style="text-align: center;">Sound blanket (R9633)</p>	
3	Remove the sound blanket (top upper).	 <p style="text-align: center;">Sound blanket (top upper) (R9634)</p>	
4	Remove the discharge pipe thermistor.	 <p style="text-align: center;">Discharge pipe thermistor (R9635)</p>	

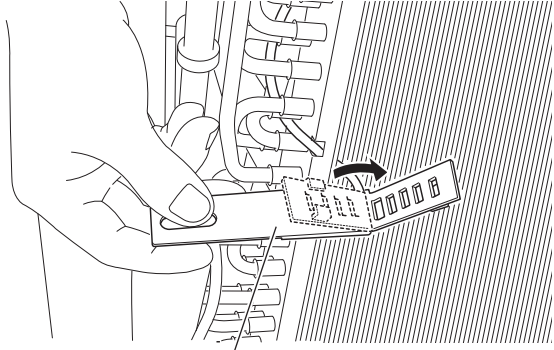
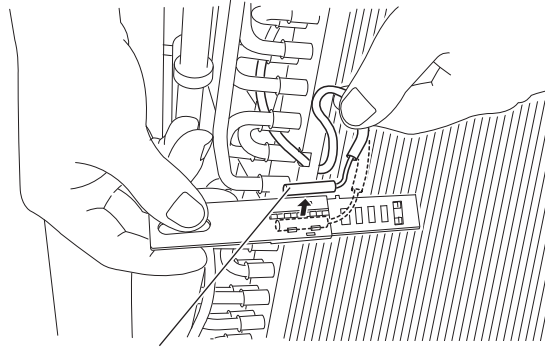
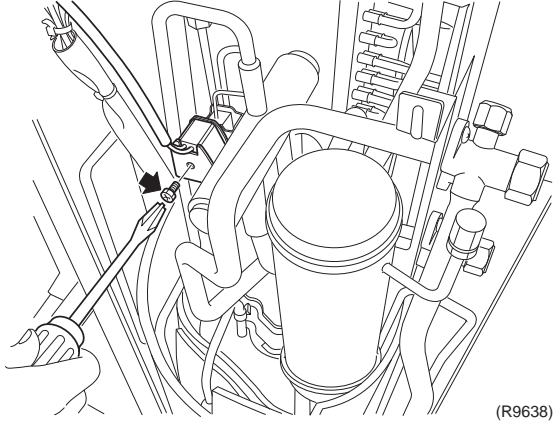
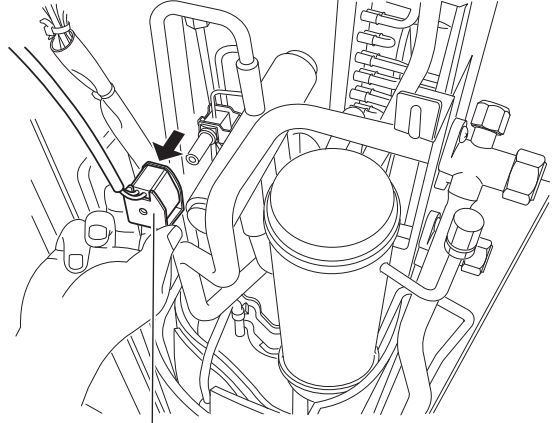
Step	Procedure	Procedure	Points
5	At the back side, open the outdoor air thermistor cover.	 <p style="text-align: center;">Outdoor air thermistor cover (R9636)</p>	
6	Release the outdoor air thermistor.	 <p style="text-align: center;">Outdoor air thermistor (R9637)</p>	
3. Removal of the four-way valve coil			
1	Remove the screw.	 <p style="text-align: center;">(R9638)</p>	
2	Remove the four-way valve coil.	 <p style="text-align: center;">Four way valve coil (R9639)</p>	

2.6 Removal of Sound Blanket

Procedure

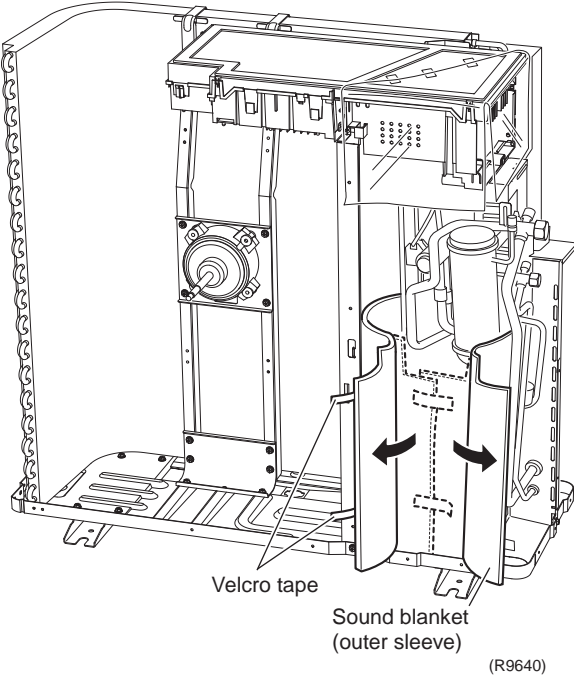
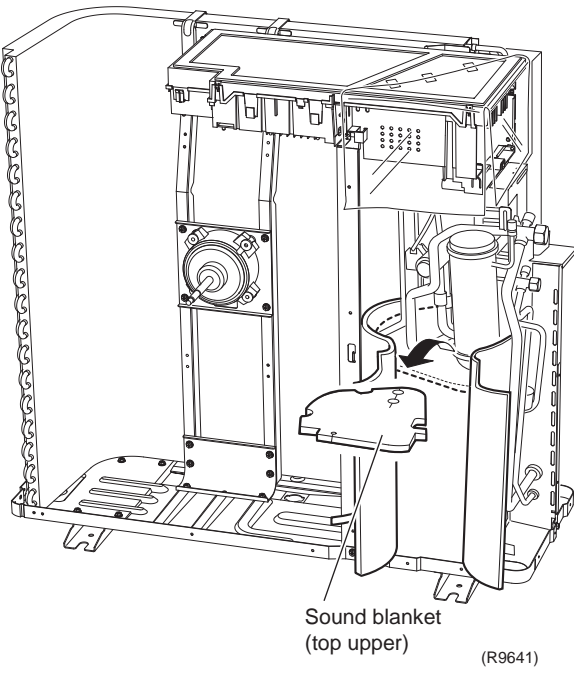

Warning Be sure to wait 10 minutes or more after turning off all power supplies before disassembly work.

Step	Procedure	Points
1	<p>Undo the 2 Velcro tapes the sound blanket, and open the sound blanket (outer sleeve).</p> 	
2	<p>Remove the sound blanket (top upper).</p> 	<ul style="list-style-type: none"> ■ The sound blanket is fragile. Carefully pass the discharge pipe through it.

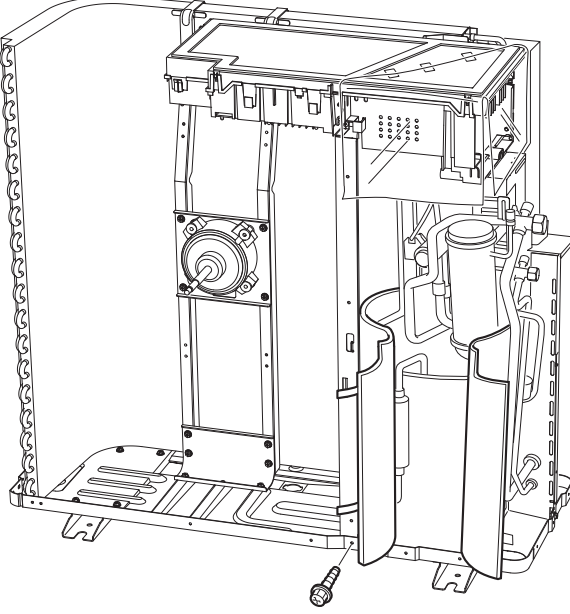
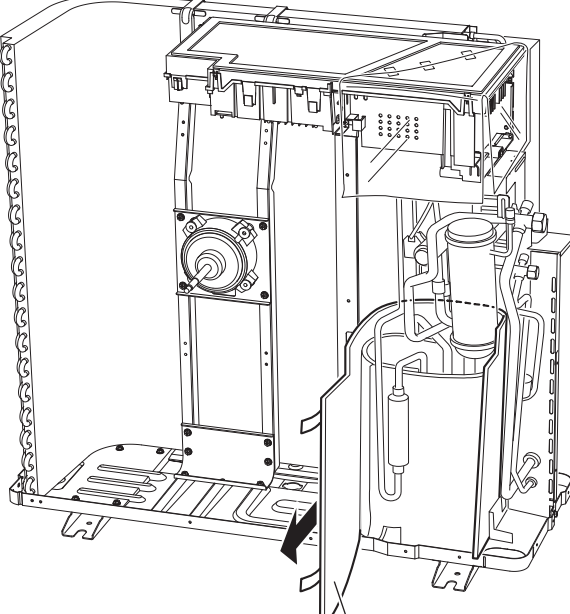
Step	Procedure	Procedure	Points
3	Remove the screw from the partition plate and open the plate slightly to the left for easy work.	 <p>(R9642)</p>	
4	Remove the sound blanket (outer sleeve).	 <p>Sound blanket (outer sleeve)</p> <p>(R9643)</p>	<ul style="list-style-type: none"> ■ The sound blanket is fragile. Be careful of the notches of the compressor mount (3 locations).

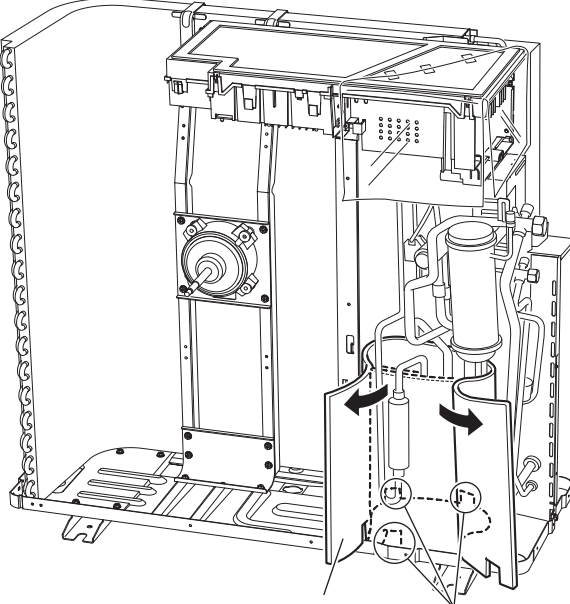
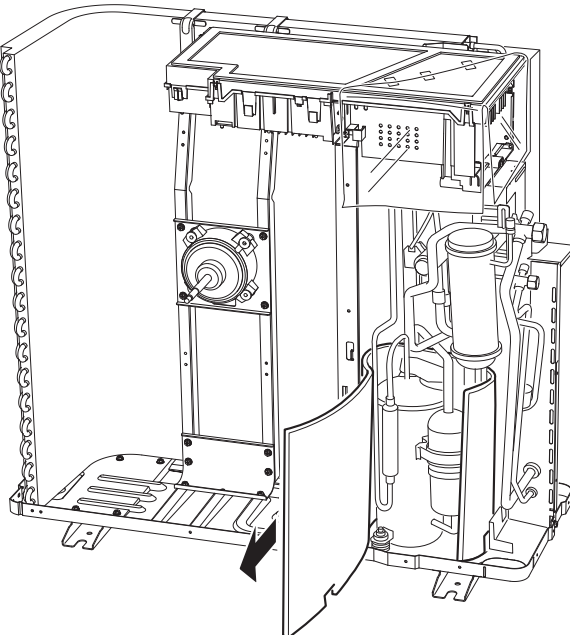
Step		Procedure	Points
5	Open the sound blanket (inner sleeve) and remove part of the muffler.	 <p data-bbox="722 861 1063 913">Sound blanket (inner sleeve) Compressor mount</p> <p data-bbox="1006 913 1071 934">(R9644)</p>	<ul style="list-style-type: none"> <li data-bbox="1112 672 1469 808">■ The sound blanket is fragile. Be careful of the notches of the compressor mount (3 locations).
6	Remove the sound blanket (outer sleeve).	 <p data-bbox="990 1627 1055 1648">(R9645)</p>	

2.7 Removal of Compressor

Procedure



Warning

Be sure to wait 10 minutes or more after turning off all power supplies before disassembly work.

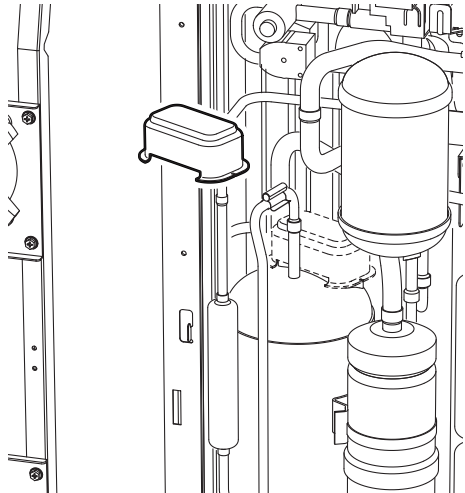
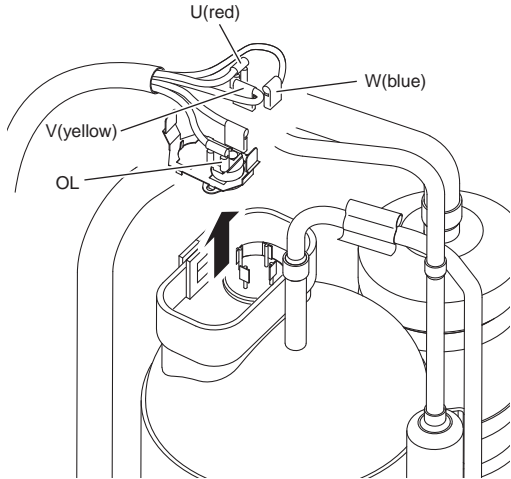
Step	Procedure	Points
1	Remove the terminal cover.  <p style="text-align: right;">(R9650)</p>	
2	Pull out the 3 leads using long-nose pliers.	■ U:red, V:yellow, W:blue
3	Remove the OL.  <p style="text-align: right;">(R9471)</p>	

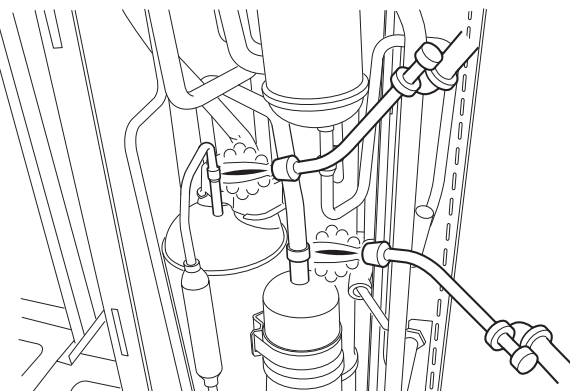
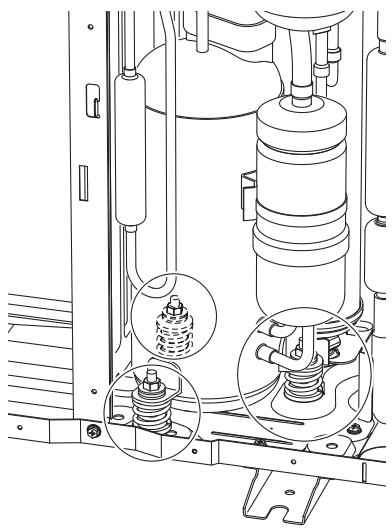
Step		Procedure	Points
4	Heat up the brazed part and withdraw the piping with pliers.	 <p style="text-align: right;">(R9646)</p>	<p>⚠ Caution Be careful not to get yourself burned with the pipes and other parts that are heated by the gas welding rod.</p> <p>⚠ Caution From the viewpoint of global environment protection, do not discharge the refrigerant gas into the atmosphere. Make sure to recover the refrigerant gas with a recovery system.</p>
	<ul style="list-style-type: none"> ■ Before working, make sure that the refrigerant circuit is empty. ■ Be sure to apply nitrogen replacement when heating up the brazed part. 		
5	<p>⚠ Warning If refrigerant gas leaks during the job, ventilate the room. (Bear in mind that if the refrigerant gas is exposed to open flames, noxious gas may be generated.)</p> <p>Remove the 3 screws.</p>	 <p style="text-align: right;">(R7021)</p>	<p>Reassembly precautions</p> <ol style="list-style-type: none"> 1. Use non-oxidizing brazing method. If nitrogen gas is not available, braze the parts speedily. 2. Avoid deterioration of the gaskets due to carbonization of oil inside the four-way valve or thermal influence. For this purpose, wrap the four-way valve with wet cloth. Splash water over the cloth against becoming too hot (keep it below 120°C). <ul style="list-style-type: none"> ■ In pulling the pipes, be careful not to over-tighten them with pliers. The pipes may get deformed. <p>If the gas welding machine fails to remove the four-way valve, take the steps below.</p> <ol style="list-style-type: none"> 1. Disconnect the brazed pipe sections that are readily easy to separate and join together later. 2. With a small copper tube cutter, cut off the internal pipes to easily take out the four-way valve. <p>Note: Never use a metal saw. The sawdust may enter into the circuit.</p> <ul style="list-style-type: none"> ■ Provide a protective sheet or a steel plate so that the brazing flame cannot influence peripheries. ■ Be careful not to break the pipes by pressing them excessively with pliers when withdrawing it.

Part 8

Other Considerations

1. Other Considerations	183
1.1 Trial Operation from the Remote Controller	183
1.2 Jumper Settings	184
1.3 Application of Silicon Grease to the Power Transistor and Diode Bridge	185

1. Other Considerations

1.1 Trial Operation from the Remote Controller

1.1.1 Trial Operation and Testing

1. Measure the supply voltage and make sure that it falls in the specified range.
2. Trial operation should be carried out in either cooling or heating mode.
3. Carry out the test operation in accordance with the Operation Manual to ensure that all functions and parts, such as louver movement, are working properly.
 - The air conditioner requires a small amount of power in its standby mode. If the system is not to be used for some time after installation, shut off the circuit breaker to eliminate unnecessary power consumption.
 - If the circuit breaker trips to shut off the power to the air conditioner, the system will restore the original operation mode when the circuit breaker is opened again.

For Heat pump

In cooling mode, select the lowest programmable temperature; in heating mode, select the highest programmable temperature.

- Trial operation may be disabled in either mode depending on the room temperature.
- After trial operation is complete, set the temperature to a normal level.
(78°F to 82°F (26°C to 28°C) in cooling mode, 68°F to 75°F (20°C to 24°C) in heating mode)
- For protection, the system disables restart operation for 3 minutes after it is turned off.

1.1.2 Trial operation from Remote Controller

- (1) Press the MODE button and select operation mode.
- (2) Press the ON/OFF button to turn on the system.
- (3) Press the both of TEMP buttons and the MODE button at the same time.
- (4) Press the MODE button twice.
(“?” will appear on the display to indicate that Trial Operation is selected.)
- (5) Trial operation terminates in approx. 30 minutes and switches into normal mode. To quit a trial operation, press the ON/OFF button.

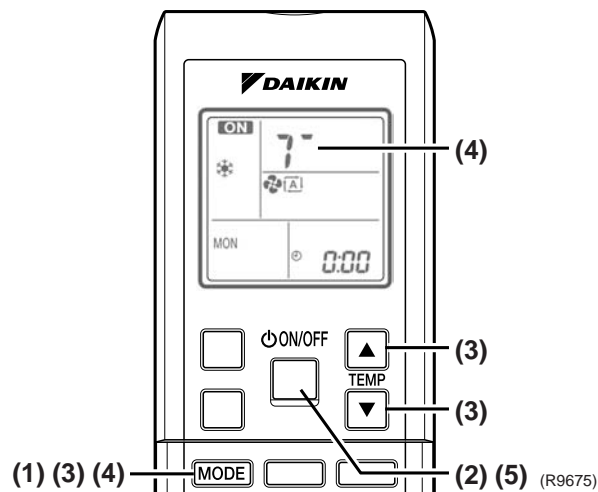

1.2 Jumper Settings

1.2.1 When 2 Units are Installed in 1 Room

When 2 indoor units are installed in 1 room, the 2 wireless remote controllers can be set for different addresses.

How to set the different addresses

- Control PCB of the indoor unit
 - (1) Remove the front grille (6 screws, 3 front grille fixtures)
 - (2) Remove the electrical wiring box. (1 screw)
 - (3) Remove the metal plate electrical wiring cover. (4 tabs)
 - (4) Cut the address jumper JA on the control PCB.

- Wireless remote controller
 - (1) Slide the front cover and take it off.
 - (2) Cut the address jumper J4.

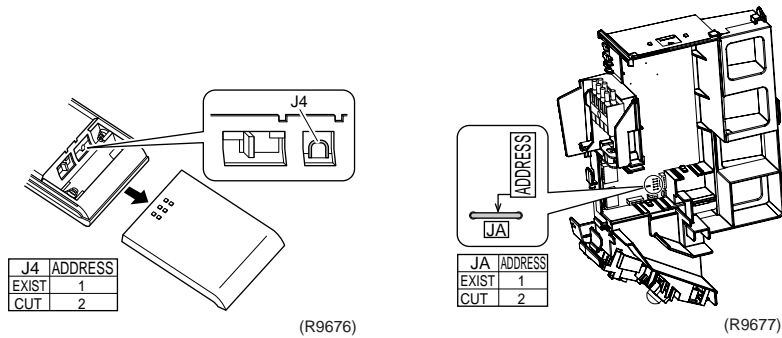

1.2.2 Jumper Setting

Jumper (On indoor control PCB)	Function	When connected (factory set)	When cut
JC	Power failure recovery function	Auto restart	Unit does not resume operation after recovering from a power failure. Timer ON-OFF settings are cleared.
JB	Fan speed setting when compressor is OFF on thermostat. (effective only at cooling operation)	Fan speed setting ; Remote controller setting	Fan rpm is set to "0" <Fan stop>

1.3 Application of Silicon Grease to the Power Transistor and Diode Bridge

Applicable Models

All outdoor units using inverter type compressor for room air conditioner.

When the printed circuit board of an outdoor unit is replaced, it is required that silicon grease (*1) is applied to the heat radiation part (the contact point to the heat radiation fin) of the power transistor and diode bridge.

*1: Parts number of the silicon grease – 1172698 (Drawing number 3FB03758-1)

Details

The silicon grease is an essential article for encouraging the heat radiation of the power transistor and the diode bridge. Applying the paste should be implemented in accordance with the following instruction.

Remark: There is the possibility of failure with smoke in case of bad heat radiation.

- Completely wipe off the old silicon grease from the heat radiation fin.
- Evenly apply the silicon grease to the whole diode bridge and power transistor.
- Do not have any foreign object such as solder or paper waste between the power transistor, the diode bridge, and the heat radiation fin.
- Firmly tighten the screws of the power transistor and the diode bridge to ensure contact to the heat radiation fin without any gap.

<Example>

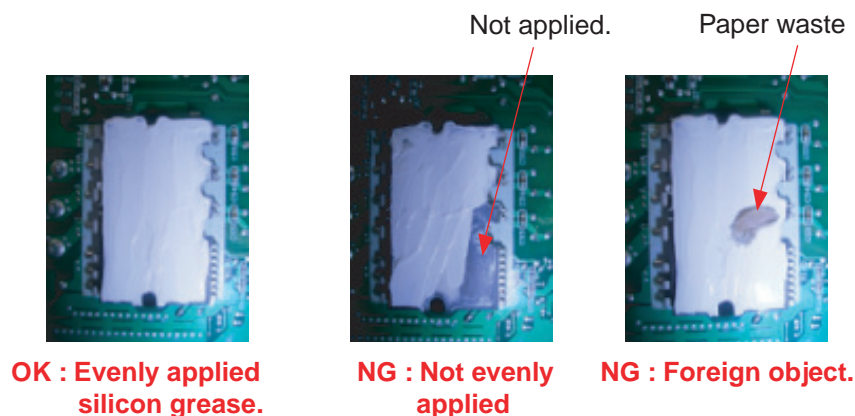
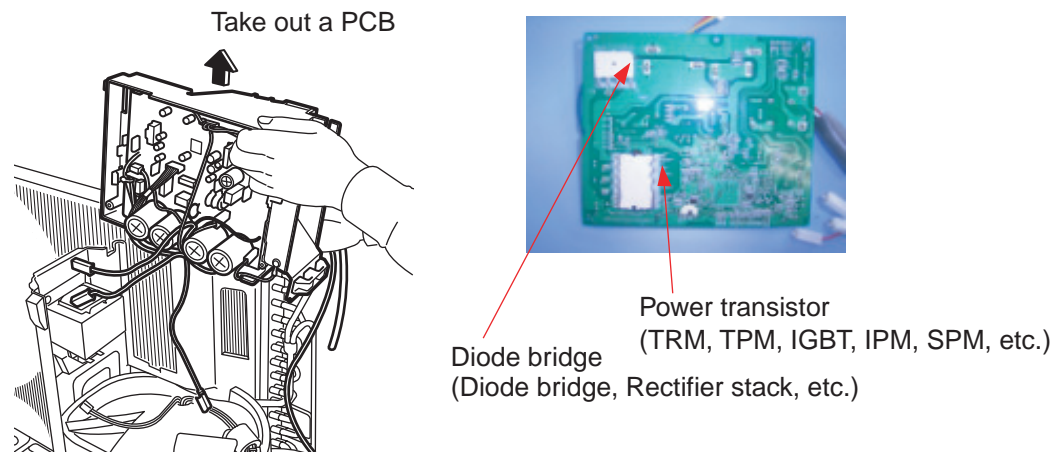

(R9056)

Part 9 Appendix

1. Piping Diagrams.....	188
2. Wiring Diagrams.....	189

2. Wiring Diagrams

FTXS30/36HVJU

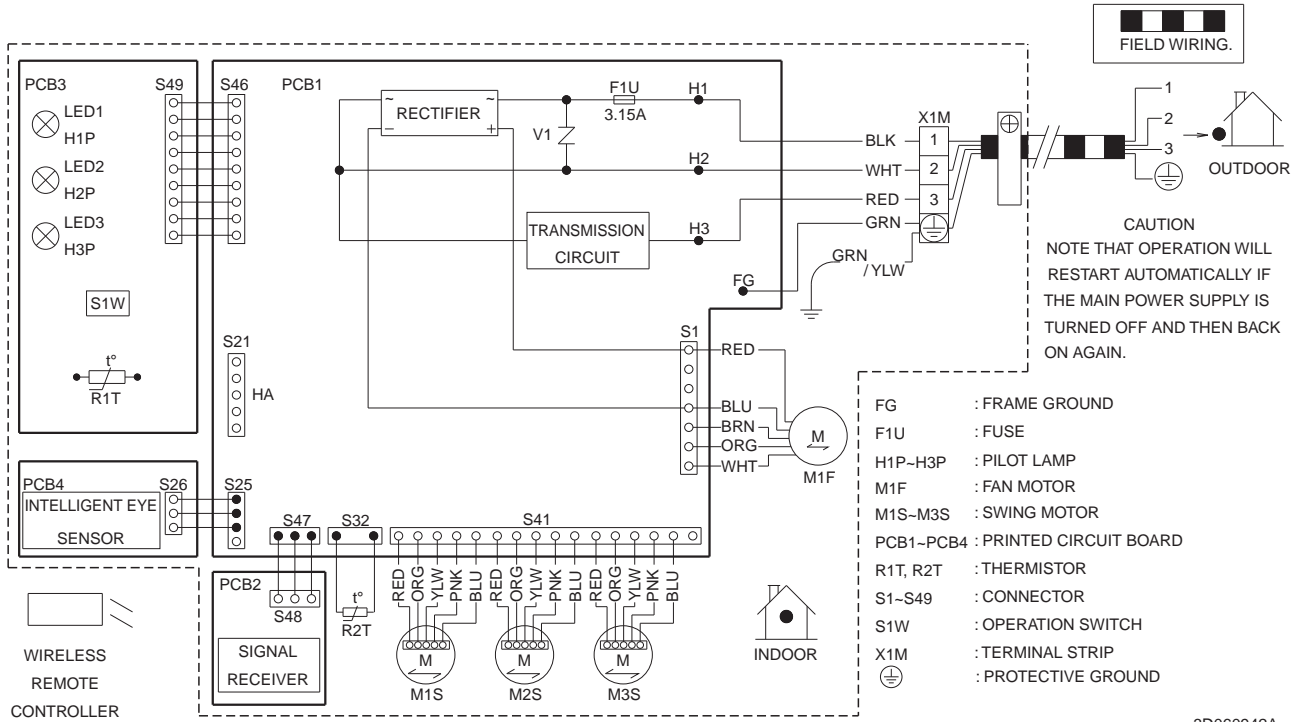

RXS30/36HVJU

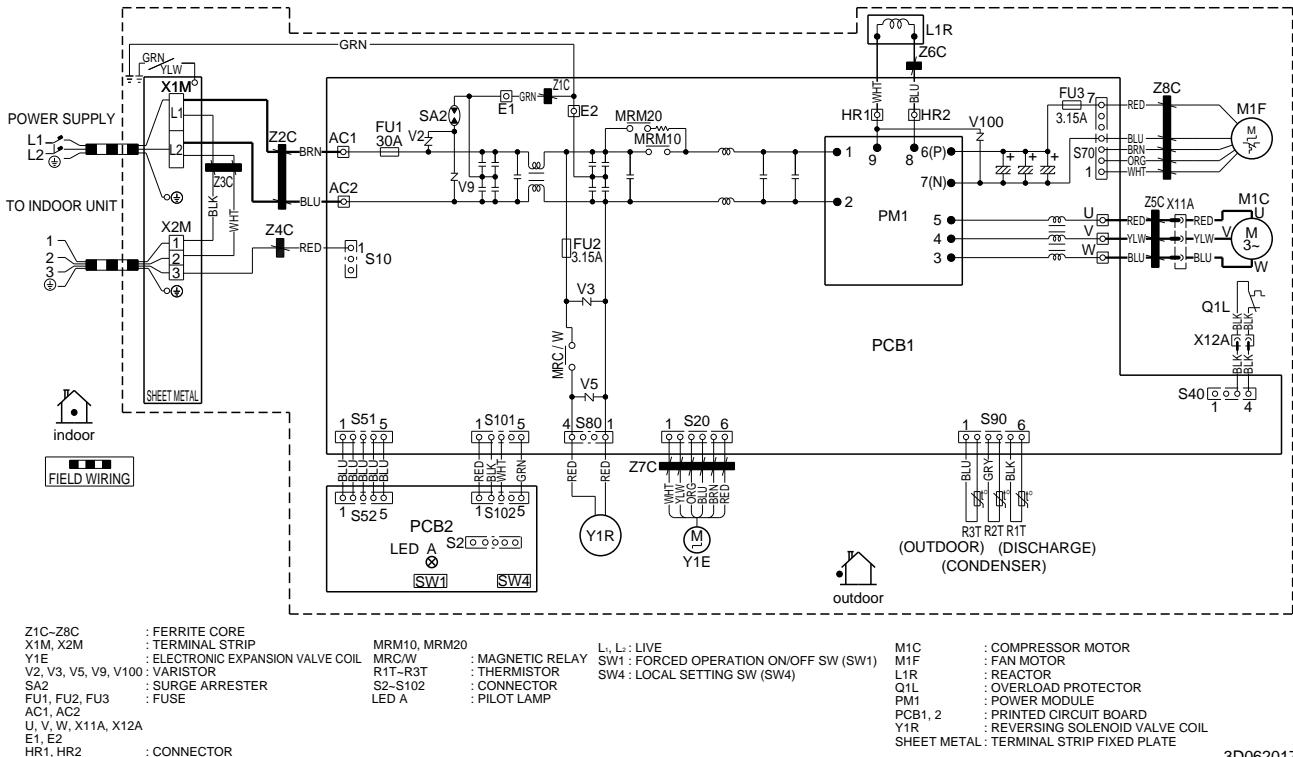

Index

Numerics

00	80	check no.13	119
3-d airflow	19	check no.15	120
3-minute standby	29, 36	coils	183
A			
a1	81	comfort airflow mode	20
a5	82	comfort airflow operation	59
a6	84	compressor	189
ac1	13	compressor lock	91
ac2	13	compressor overload	90
address setting jumper	11	compressor protection function	37
adjusting the airflow direction	56	compressor system sensor abnormality	98
air filter	123	connectors	11, 13
air filter (prefilter)	29	control pcb (indoor unit)	12
airflow direction control	19	ct or related abnormality	101
auto · dry · cool · heat · fan operation	54	D	
automatic airflow control	20	dc fan lock	92
automatic operation	22	defrost control	40
auto-restart	11	diode bridge	107, 195
auto-restart function	29	discharge grille	165
auto-swing	19	discharge pipe	43
C			
c4	86	discharge pipe temperature control	44, 96
c9	86	discharge pipe thermistor	31, 43, 104, 184
capacitor voltage check	119	discharge pressure check	117
centralized control	11	display pcb	12
check		drain hose	155
capacitor voltage check	119	drip proof plate	129
discharge pressure check	117	E	
electronic expansion valve check	114	e1	89
fan motor connector output check	114	e5	90
four way valve performance check	115	e6	91
installation condition check	117	e7	92
inverter units refrigerant system check	118	e8	93
outdoor unit fan system check	118	ea	94
power supply waveforms check	118	earth	130
power transistor check	119	econo mode	25
thermistor resistance check	116	econo operation	63
turning speed pulse input on the outdoor unit pcb		electrical box	129, 132, 175
check	120	electrical box temperature rise	105
check no.01	114	electronic expansion valve check	114
check no.04	114	electronic expansion valve control	42
check no.05	115	error codes	
check no.06	116	00	80
check no.07	117	a1	81
check no.08	117	a5	82
check no.09	118	a6	84
check no.10	118	c4	86
check no.11	118	c9	86
check no.12	119	e1	89
		e5	90
		e6	91
		e7	92

e8	93	h6	99
ea	94	h8	101
f3	96	h9	103
f6	97	ha	11
h0	98	hall ic	20, 84
h6	99	heat exchanger	155, 157
h8	101	heat exchanger thermistor	86, 183
h9	103	high pressure control	82
j3	103	high pressure control in cooling	97
j6	103	horizontal blades	144
l3	105	hot start function	29
l4	106	hr1	13
l5	108	hr2	13
p4	103		
u0	110	I	
u2	112	indoor heat exchanger thermistor	31, 130
u4	87	indoor unit pcb abnormality	81
u7	113	input current control	38
ua	88	input overcurrent detection	93
error codes and description	80	installation condition check	117
		instruction	52
F		insufficient gas	110
f3	96	insufficient gas control	45
f6	97	intelligent eye	26
facility setting jumper	47	intelligent eye operation	59
facility setting switch	47	inverter features	17
fan control	40	inverter powerful operation	28
fan guards	146	inverter principle	17
fan motor	131, 152, 182	inverter units refrigerant system check	118
fan motor (dc motor) or related abnormality	84		
fan motor connector output check	114	J	
fan rotor	159	j3	103
fan speed control	20	j4	194
fan speed setting	11, 194	j6	103
forced operation mode	46	ja	11, 194
forced operation on/off switch	11, 13	jb	11, 194
four way valve abnormality	94	jc	11, 194
four way valve coil	185	jumper settings	194
four way valve operation compensation	36		
four way valve performance check	115	L	
four way valve switching	36	l3	105
freeze-up protection control	39, 82	l4	106
frequency control	17, 33	l5	108
frequency principle	17	led a	11, 13
front grille	126	led1	11
front panel	123, 125, 164, 165	led2	11
fu1	11, 13	led3	11
fu2	13	liquid compression protection function 2	40
fu3	13	list of functions	3
functions, list of	3	lower limit for cooling	47
fuse	11, 13	low-voltage detection	112
G		M	
gas piping	155	main pcb	14
		mode hierarchy	32
H		motor	
h0	98	fan motor	131, 152, 182

N	
night set mode	24
O	
ol activation	90
on/off button on indoor unit	29
opening limit	43
operation lamp	75
outdoor air temperature thermistor	104
outdoor heat exchanger thermistor	31, 104
outdoor unit fan system check	118
outdoor unit pcb abnormality	89
outdoor unit quiet operation	62
output overcurrent detection	108
overcurrent	45, 93, 108
overload	45, 90
over-voltage detection	112
P	
p4	103
pcb, removal of	136, 179
phase steps	20
pi control	34
pipng diagrams	199
pipng fixture	156
position sensor abnormality	99
power failure recovery function	11, 194
power supply waveforms check	118
power transistor	107, 195
power transistor check	119
power-airflow dual flaps	19
powerful operation	28, 46, 61
preheating operation	35
pressure equalization control	43
printed circuit board (pcb)	
control pcb (indoor unit)	12
display pcb	12
main pcb	14
service monitor pcb	14
signal receiver pcb	12
problem symptoms and measures	76
program dry function	21
R	
radiation fin temperature rise	106
radiation fin thermistor	104
remote controller	52, 193
room temperature thermistor	86
rth1	11
S	
s1	11, 131
s10	13
s101	13
s102	13
s20	13, 176
s21	11
s25	11
s32	11
s40	13
s41	132
s41	11, 132
s46	11
s47	11
s48	11
s49	11
s51	13
s52	13
s70	13, 176
s80	13, 176
s90	13, 176
sensor malfunction detection	45
service check function	77
service cover	126
service monitor pcb	14
shelter	133
side panel	162
signal receiver	123
signal receiver pcb	12
signal receiving sign	29
signal transmission error	87
signal transmission error on outdoor unit pcb	113
silicon grease	107, 195
sound blanket	186
specifications	7
starting operation control	43
suction grille	161
sw1	11, 13
sw4	13
swing motors	144
switch b	47
T	
terminal strip	131
test run	193
thermistor	
discharge pipe thermistor	31, 43, 104, 184
heat exchanger thermistor	86, 183
indoor heat exchanger thermistor	130
indoor heat exchanger thermistor	31
outdoor air temperature thermistor	104
outdoor heat exchanger thermistor	31, 104
radiation fin thermistor	104
room temperature thermistor	86
thermistor or related abnormality (indoor unit)	86
thermistor or related abnormality (outdoor unit)	103
thermistor resistance check	116
thermistor, removal of	183
thermostat control	23
timer operation	64
titanium apatite photocatalytic air-purifying filter	29, 124
top panel	162
troubleshooting	80
troubleshooting with the led indication	75

turning speed pulse input on the outdoor unit pcb check

120

U

u0	110
u2	112
u4	87
u7	113
ua	88
unspecified voltage	88

V

v1	11
varistor	11
vertical blades	144
voltage detection function	46

W

weekly timer operation	30, 66
wide-angle louvres	19
wiring diagrams	200

Drawings & Flow Charts

Numerics		frequency control	33
3-d airflow	19	frequency principle	17
A		H	
automatic airflow control	20	high pressure control in cooling	97
automatic operation	22	I	
auto-swing	19	indoor unit pcb abnormality	81
C		input current control	38
capacitor voltage check	119	input over current detection	93
check no.01	114	installation condition check	117
check no.04	114	insufficient gas	110
check no.05	115	insufficient gas control	45
check no.06	116	intelligent eye	26
check no.07	117	inverter features	17
check no.08	117	inverter powerful operation	28
check no.09	118	inverter units refrigerant system check	118
check no.10	118	J	
check no.11	118	jumper settings	194
check no.12	119	L	
check no.13	119	low-voltage detection	112
check no.15	120	M	
comfort airflow mode	20	main pcb	14
compressor lock	91	mode hierarchy	32
compressor protection function	37	N	
compressor system sensor abnormality	98	night set mode	24
control pcb (indoor unit)	12	O	
ct or related abnormality	101	ol activation (compressor overload)	90
D		on/off button on indoor unit	29
dc fan lock	92	operation lamp, location	75
defrost control	40	outdoor unit fan system check (with dc motor)	118
diode bridge	195	outdoor unit pcb abnormality	89
discharge pipe temperature control	96	output overcurrent detection	108
discharge pressure check	117	over-voltage detection	112
display pcb	12	P	
E		phase steps	20
econo mode	25	piping diagrams	
electrical box temperature rise	105	ftxs30hvju	199
electronic expansion valve check	114	ftxs36hvju	199
electronic expansion valve control	42	rxs30hvju	199
F		rxs36hvju	199
facility setting switch	47	position sensor abnormality	99
fan motor (dc motor) or related abnormality	84	power supply waveforms check	118
fan motor connector output check	114	power transistor	195
four way valve abnormality	94	power transistor check	119
four way valve performance check	115		
freeze-up protection control	39		
freeze-up protection control or high pressure control	82		

powerful operation	28
programme dry function	21
R	
radiation fin temperature rise	106
S	
service check function	77
service monitor pcb	14
signal receiver pcb	12
signal transmission error (between indoor and outdoor units)	87
signal transmission error on outdoor unit pcb	113
silicon grease	195
T	
target discharge pipe temperature control	44
thermistor	
heat pump model	31
thermistor or related abnormality (indoor unit)	86
thermistor or related abnormality (outdoor unit)	103
thermistor resistance check	116
thermostat control	23
trial operation from remote controller	193
troubleshooting with the led indication	75
turning speed pulse input on the outdoor unit pcb check	
120	
U	
unspecified voltage (between indoor and outdoor units)	
88	
W	
wiring diagrams	
ftxs30hvju	200
ftxs36hvju	200
rxs30hvju	200
rxs36hvju	200

Warning



- Daikin Industries, Ltd.'s products are manufactured for export to numerous countries throughout the world. Daikin Industries, Ltd. does not have control over which products are exported to and used in a particular country. Prior to purchase, please therefore confirm with your local authorized importer, distributor and/or retailer whether this product conforms to the applicable standards, and is suitable for use, in the region where the product will be used. This statement does not purport to exclude, restrict or modify the application of any local legislation.
- Ask a qualified installer or contractor to install this product. Do not try to install the product yourself. Improper installation can result in water or refrigerant leakage, electrical shock, fire or explosion.
- Use only those parts and accessories supplied or specified by Daikin. Ask a qualified installer or contractor to install those parts and accessories. Use of unauthorized parts and accessories or improper installation of parts and accessories can result in water or refrigerant leakage, electrical shock, fire or explosion.
- Read the User's Manual carefully before using this product. The User's Manual provides important safety instructions and warnings. Be sure to follow these instructions and warnings.

If you have any inquiries, please contact your local importer, distributor and/or retailer.



© 2004 Daikin Industries, Limited.

Daikin®, Daikin AC™, Absolute Comfort™, VRV® and REFNET™ are trademarks pending or registered trademarks of Daikin Industries, Limited. All rights reserved. LonWorks® and LON® are registered trademarks of Echelon Corporation. BACnet® is a Data Communication Protocol for Building Automation and Control Networks, developed under the auspices of the American Society of Heating, Refrigerating and Air-Conditioning Engineers (ASHRAE).



JMI-0107



JQA-1452

About ISO 9001

ISO 9001 is a plant certification system defined by the International Organization for Standardization (ISO) relating to quality assurance. ISO 9001 certification covers quality assurance aspects related to the "design, development, manufacture, installation, and supplementary service" of products manufactured at the plant.



EC99J2044

About ISO 14001

ISO 14001 is the standard defined by the International Organization for Standardization (ISO) relating to environmental management systems. Our group has been acknowledged by an internationally accredited compliance organisation as having an appropriate programme of environmental protection procedures and activities to meet the requirements of ISO 14001.

Dealer

DAIKIN AC (AMERICAS), INC.

1645 Wallace Drive, Suite 110
Carrollton, TX75006
info@daikinac.com
www.daikinac.com

©All rights reserved

● Specifications, designs and other content appearing in this brochure are current as of February 2010 but subject to change without notice.